

Panaria
ceramica

CATALOGO GENERALE

20

23

La bellezza di sentirsi a casa



**The beauty of feeling at home
Das schöne Gefühl, sich zu Hause zu fühlen
La beauté de se sentir chez soi**

Indice generale

List of contents_Inhalt_Index général

I nostri valori 6

Our values_Unsere Werte_Nos valeurs

Le nostre eccellenze 14

Our excellences_Unsere Exzellenz_
Nos excellences

Protect	16
Zero.3	18
Think Zero	22
20 mm	24
Soluzioni Decorative	26

Il nostro Gruppo 28

Our Group_Unsere Unternehmensgruppe_
Notre Groupe

Le collezioni 36

Collections_Kollektionen_Collections

Assi d'Alpe	238
Bioarch	44
Blade	302
Borealis	246
Context	156
Cross Wood	260
Discover	52
Eternity	206
Even	318
Experience	170
Frame	64
Glam	332
Iqoniqa	350
Kairos	270
Memory Mood	178
Must	368
Nuance	286
Pierre des Rêves	78
Pietre di Fanes	92
Prime Stone	98
Stone Trace	112
The Place	124
Trilogy	222
Urbanature	188
Via Maestra	138
Wallcraft	378

Dati tecnici 392

Technical data_Technische Daten_
Données techniques

Panaria sviluppo ecosostenibile	394
Panaria sustainable development_ Panaria umweltschonende nachhaltige Entwicklung_Panaria développement durable	

Certificazioni di sistema	398
Management system certifications_ Qualitätssystem Zertifizierungen_ Certifications du système de gestion	

Certificazioni di prodotto	399
Product certifications_Produktzertifizierungen_ Certifications de produits	

Prodotti certificati	401
Certified products_Zertifizierte Produkte_ Produits certifiés	

Norme tecniche di riferimento	402
Technical standards_Technische Bezugsnormen_Normes techniques	

Caratteristiche tecniche	408
Technical features_Technische Eigenschaften_ Caractéristiques techniques	

Destinazioni d'uso	416
Intended use_Einsatzbereiche_ Utilisations prévues	

Tabelle calibri	418
Size table_Formattabellen_ Tableaux des calibres	

Suggerimenti per la posa	420
Laying suggestions_Empfehlungen für das Verlegen_Conseils pour la pose	

Informazioni per la pulizia e la manutenzione	422
Cleaning and maintenance information_ Informationen zur reinigung und pflege_ Informations sur le nettoyage et l'entretien	

Resistenza allo scivolamento	427
Slip resistance_Rutschfestigkeit_ Résistance au glissement	

Indice alfabetico dei prodotti	428
List of products in alphabetical order_ Alphabetisches verzeichnis der Produkte_ Index alphabétique des produits	

Condizioni generali di vendita	432
General terms and conditions of sale_ Allgemeine Verkaufsbedingungen_ Conditions générales de vente	

Indice per effetto

Index by look_Effekt Zuordnung_
Index par effet

Effetto Pietra

Stone look_Stein-Optik_Effet pierre

Bioarch		44
Discover	[P]	52
Frame		64
Pierre des Rêves	[P]	78
Pietre di Fanes		92
Prime Stone	[P]	98
Stone Trace	[P]	112
The Place	[P]	124
Via Maestra	[P]	138

Effetto Cemento

Concrete look_Zement-Optik_Effet ciment

Context	[P]	156
Experience	[P]	170
Memory Mood		178
Urbanature	[P]	188

Effetto Marmo

Marble look_Marmor-Optik_Effet marbre

Eternity	[P]	206
Trilogy	[P]	222

Effetto Legno

Wood look_Holz-Optik_Effet bois

Assi d'Alpe		238
Borealis	[P]	246
Cross Wood		260
Kairos	[P]	270
Nuance	[P]	286

Effetto Cromatico

Chromatic look_Chromatischer Effekt_
Effet chromatique

Blade	[P]	302
Even		318
Glam		332
Iqoniqa	[P]	350
Must	[P]	368
Wallcraft		378

Indice per tecnologia

Index by technology_Technologie
Zuordnung_Index par technologie

Zero.3

Gres porcellanato laminato_Laminated porcelain
stoneware_Laminiertes Feinsteinzeug_
Grès cérame laminé

Blade	[P]	302
Experience	[P]	170
Glam		332
Must	[P]	368
Prime Stone	[P]	98
Stone Trace	[P]	112
Trilogy	[P]	222
Urbanature	[P]	188

Gres Porcellanato

Porcelain stoneware_Feinsteinzeug_Grès cérame

Assi d'Alpe		238
Bioarch		44
Borealis	[P]	246
Context	[P]	156
Cross Wood		260
Discover	[P]	52
Eternity	[P]	206
Frame		64
Iqoniqa	[P]	350
Kairos	[P]	270
Memory Mood		178
Nuance	[P]	286
Pierre des Rêves	[P]	78
Pietre di Fanes		92
Prime Stone	[P]	98
The Place	[P]	124
Trilogy	[P]	222
Urbanature	[P]	188
Via Maestra	[P]	138

20 mm

Alto spessore_High thickness_20 mm Stärke_
Forte épaisseur

Bioarch		44
Borealis		246
Context		156
Cross Wood		260
Discover		52
Frame		64
Kairos		270
Nuance		286
Pierre des Rêves		78
Prime Stone		98
The Place		124
Urbanature		188
Via Maestra		138

Monoporosa

Single-fired wall tiles_Weißschärbige wandfliese_
Faïence

Even		318
Iqoniqa		350
Wallcraft		378

Indice per formati

Index by sizes_Index nach Formaten_Index par formats

100x300

Blade	302
Experience	170
Must	368
Prime Stone	98
Trilogy	222
Urbanature	188

120x278

Stone Trace	112
-------------	-----

100x250

Prime Stone	98
-------------	----

120x120

Frame	64
Stone Trace	112
Via Maestra	138

100x100

Blade	302
Experience	170
Must	368
Prime Stone	98
Trilogy	222
Urbanature	188

50x100

Blade	302
Experience	170
Glam	332
Must	368
Prime Stone	98
Trilogy	222
Urbanature	188

35x100

Even	318
Iqoniqa	350
Wallcraft	378

30x180

Borealis	246
Nuance	286

20x180

Borealis	246
Nuance	286

60x120

Context	156
Discover	52
Eternity	206
Frame	64
Pierre des Rêves	78
Stone Trace	112
The Place	124
Trilogy	222
Via Maestra	138

40x120

Borealis	246
Kairos	270
Nuance	286

30x120

Cross Wood	260
Kairos	270
Nuance	286

20x120

Borealis	246
Cross Wood	260
Kairos	270
Nuance	286

20x90,5

Assi d'Alpe	238
-------------	-----

90x90

Context	156
Pierre des Rêves	78
Prime Stone	98
The Place	124
Urbanature	188

60x90

Via Maestra	138
-------------	-----

45x90

Prime Stone	98
Urbanature	188

22,5x90

Urbanature	188
------------	-----

60x60

Bioarch	44
Context	156
Discover	52
Eternity	206
Frame	64
Iqoniqa	350
Memory Mood	178
Pierre des Rêves	78
Prime Stone	98
The Place	124
Trilogy	222
Urbanature	188
Via Maestra	138

40x60

Via Maestra	138
-------------	-----

30x60

Context	156
Discover	52
Eternity	206
Frame	64
Pierre des Rêves	78
Prime Stone	98
The Place	124
Trilogy	222
Urbanature	188
Via Maestra	138

20x60

Discover	52
----------	----

15x60

Discover	52
The Place	124

7,5x60

Discover	52
Kairos	270
The Place	124

5x60

Discover	52
The Place	124

50x50

Experience	170
------------	-----

20x40

Bioarch	44
Pierre des Rêves	78
Pietre di Fanes	92
The Place	124

20x30

Bioarch	44
Pierre des Rêves	78
Pietre di Fanes	92
The Place	124

20x20

Bioarch	44
Memory Mood	178
Pierre des Rêves	78
Pietre di Fanes	92
The Place	124



Benvenuto nella casa Panaria

Welcome to Panaria world
Willkommen daheim mit Panaria
Bienvenue chez Panaria

Da sempre scegliamo il meglio per la tua casa.
“La bellezza di sentirsi a casa” è il piacere di vivere in spazi armonici e versatili, nei quali esprimerci liberamente e dare il meglio di noi. Nel corso del tempo abbiamo voluto e saputo evolverci per essere sempre più vicini all’ideale abitativo di tante persone e di tanti progettisti, in tutto il mondo.

Choosing the best for your home.
“The beauty of feeling at home” implies the joy of living in harmonious and versatile spaces in which to freely express and give the best of ourselves. Over time we have successfully evolved to get closer and closer to the residential ideal of individuals and designers worldwide.

Für Ihr Zuhause wählen wir seit jeher nur das Beste.
Es ist schön, sich zu Hause zu fühlen. Und es macht Freude, in harmonischen und vielseitigen Räumen zu leben, in denen wir uns frei ausdrücken und uns von unserer besten Seite zeigen können. Im Laufe der Zeit haben wir uns weiterzuentwickeln gewusst, um uns immer mehr jenem Ideal vom Wohnen anzunähern, das viele Menschen und Planer in aller Welt teilen.

Depuis toujours, nous choisissons ce qu’il y a de mieux pour votre maison.
« La beauté de se sentir chez soi », c’est le plaisir de vivre dans des espaces harmonieux et polyvalents dans lesquels nous pouvons nous exprimer librement et donner le meilleur de nous-mêmes. Au fil du temps, nous avons voulu et avons su évoluer pour nous rapprocher toujours plus de l’habitat idéal de tant de personnes et de tant d’architectes, partout dans le monde.





La casa che hai sempre sognato

The home you've always dreamed of
Die Wohnung, von der Sie immer geträumt haben
La maison dont vous avez toujours rêvé

Vogliamo aiutarti a realizzare la casa dei tuoi sogni, da vivere fino in fondo ogni giorno, in modo sempre nuovo, sempre più tuo. Perché questa è la casa Panaria: uno spazio intimo, che custodisce la tua storia e che vibra al ritmo delle tue emozioni più autentiche, specchio di ciò che sei e del tuo stile di vita.

We want to help you create the home of your dreams, a place that you can thoroughly enjoy every day in ways that are always new and more personal. Because that is the Panaria home: an intimate space that houses your stories and vibrates with the rhythm of your most authentic emotions, a mirror of who you are and of your lifestyle.

Wir können Ihnen dabei helfen, Ihre Traumwohnung zu verwirklichen. Eine Wohnung, die Sie Tag für Tag immer wieder neu erleben und die Ihrer Persönlichkeit immer besser entspricht. Denn Wohnen mit Panaria heißt: Ein einladender Raum, der Ihre Geschichte hütet und Ihre wahrsten Emotionen begleitet. Ein Spiegel Ihres Wesens und Ihres Lebensstils.

Nous voulons vous aider à réaliser la maison de vos rêves – une maison qui vous ressemble, où vous pourrez vous épanouir chaque jour, dans un esprit de renouveau permanent. Car c'est cela, la maison Panaria : un espace intime qui préserve votre histoire et vibre au rythme de vos émotions les plus authentiques, miroir de ce que vous êtes et de votre style de vie.



Una credibilità che ha radici profonde

Deeply rooted credibility
Glaubwürdigkeit mit starken Wurzeln
Une crédibilité aux racines profondes

Guardiamo al futuro con lo stesso entusiasmo del 1974 e, oggi, con la credibilità che ci danno le solide e durature relazioni che intratteniamo col territorio in cui operiamo e coi clienti. Da quasi 50 anni siamo vicini a tante storie di casa, forti della nostra tradizione e consapevoli che un futuro migliore passa anche attraverso la qualità degli spazi in cui viviamo.

We look to the future with the same enthusiasm as we did in 1974, emboldened by the credibility that we have earned through the solid and long-standing relationships we have developed in the regions where we operate and with our clients. After almost 50 years, we're a part of many home stories, strengthened by our tradition and aware that a better future also begins with the quality of our living spaces.

Wir blicken heute mit demselben Enthusiasmus in die Zukunft wie 1974, und erfreuen uns dazu einer Glaubwürdigkeit, die wir unseren soliden und dauerhaften Beziehungen zu unserem Territorium sowie zu unseren Kunden verdanken. Seit fast 50 Jahren ist das Wohnen unser wichtigstes Anliegen, denn wir wissen aus Tradition, dass eine bessere Zukunft auch durch die Qualität der Räume, in denen wir leben, erreicht wird.

Nous regardons vers l'avenir avec le même enthousiasme qu'en 1974, et avec la crédibilité que nous donnent aujourd'hui les relations solides et durables que nous entretenons avec le territoire dans lequel nous opérons et avec nos clients. Depuis près de 50 ans, nous nous sommes liés à tant d'histoires de maison, forts de notre tradition et conscients qu'un avenir meilleur passe également par la qualité des espaces dans lesquels nous vivons.





Protagonisti dell'abitare contemporaneo

Pioneers in modern living
Protagonisten der aktuellen Wohnkultur
Pionniers du logement moderne

Ogni giorno lavoriamo per la soddisfazione dei nostri clienti, sparsi nei cinque continenti. Grazie a una rete commerciale capillare e competente possiamo essere sempre al loro fianco, e continuare – insieme – a raccogliere successi: progetti di assoluto prestigio che, in tutto il mondo, fanno affidamento sulla bellezza e sulla qualità delle nostre superfici.

Every day we work to satisfy our clients, scattered across five continents. Thanks to a widespread and competent sales network, we are always by their side and continue – together – to complete successful and prestigious projects that, across the globe, rely on the beauty and quality of our surfaces.

Wir engagieren uns Tag für Tag dafür, dass unsere Kunden auf allen fünf Kontinenten zufrieden sind. Mit unserem engmaschigen und kompetenten Vertriebsnetz sind wir stets für die Kunden da und ernten mit ihnen gemeinsam viele Erfolge: Prestigeprojekte in aller Welt, die auf die Schönheit und die Qualität unserer Beläge zählen können.

Chaque jour, nous travaillons pour satisfaire nos clients aux quatre coins du globe. Grâce à un vaste réseau commercial compétent, nous pouvons toujours être à leurs côtés et continuer – ensemble – à célébrer nos réussites : des projets toujours plus prestigieux qui, partout dans le monde, s'appuient sur la beauté et la qualité de nos surfaces.

Le nostre eccellenze



Our excellences_ Unsere Exzellenz_ Nos excellences



P R () T E C T ®

Per un abitare sano, sicuro e protetto

To live healthily, safe and secure
Für ein gesundes, sicheres und geschütztes Wohnen
Pour un habitat sain, sûr et protégé

L'esclusiva tecnologia Panariagroup per pavimenti e rivestimenti antibatterici ad altissime performance.

The exclusive Panariagroup technology for antimicrobial floor and wall coverings with the highest performance.

Die exklusive Technologie Panariagroup für antibakterielle und hochleistungsfähige Fußböden und Verkleidungen.

La technologie exclusive de Panariagroup pour sols et revêtements antibactériens aux performances très élevées.



AZIONE POTENTE

elimina i batteri e ne impedisce la proliferazione

POWERFUL ACTION

eliminates microbes and prevents their reproduction

LEISTUNGSSTARKE WIRKUNG

eliminiert Bakterien und verhindert die Vermehrung

ACTION PUISSANTE

élimine les bactéries et empêche leur prolifération



EFFICACIA ETERNA

grazie alla tecnologia integrata in modo permanente nel prodotto

ETERNAL EFFECTIVENESS

thanks to the technology permanently integrated into the product

DAUERHAFT WIRKSAMKEIT

dank der permanent im Produkt integrierten Technologie

EFFICACITÉ ÉTERNELLE

grâce à la technologie intégrée de façon permanente dans le produit



PROTEZIONE CONTINUA

sempre attivo, 24 ore su 24, con e senza luce solare

CONTINUOUS PROTECTION

always active, 24 hours a day, with and without sunlight

DAUERSCHUTZ

rund um die Uhr aktiv, mit oder ohne Sonnenlicht

PROTECTION CONTINUE

toujours actif, 24 heures sur 24, avec et sans lumière du soleil

con - with - mit - avec

MICROBAN®

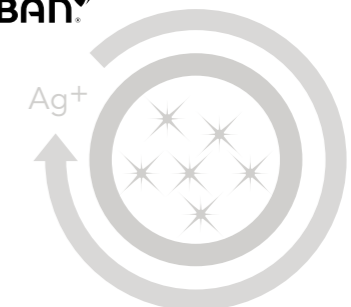

protect.panariagroup.it

PANARIAgroup®

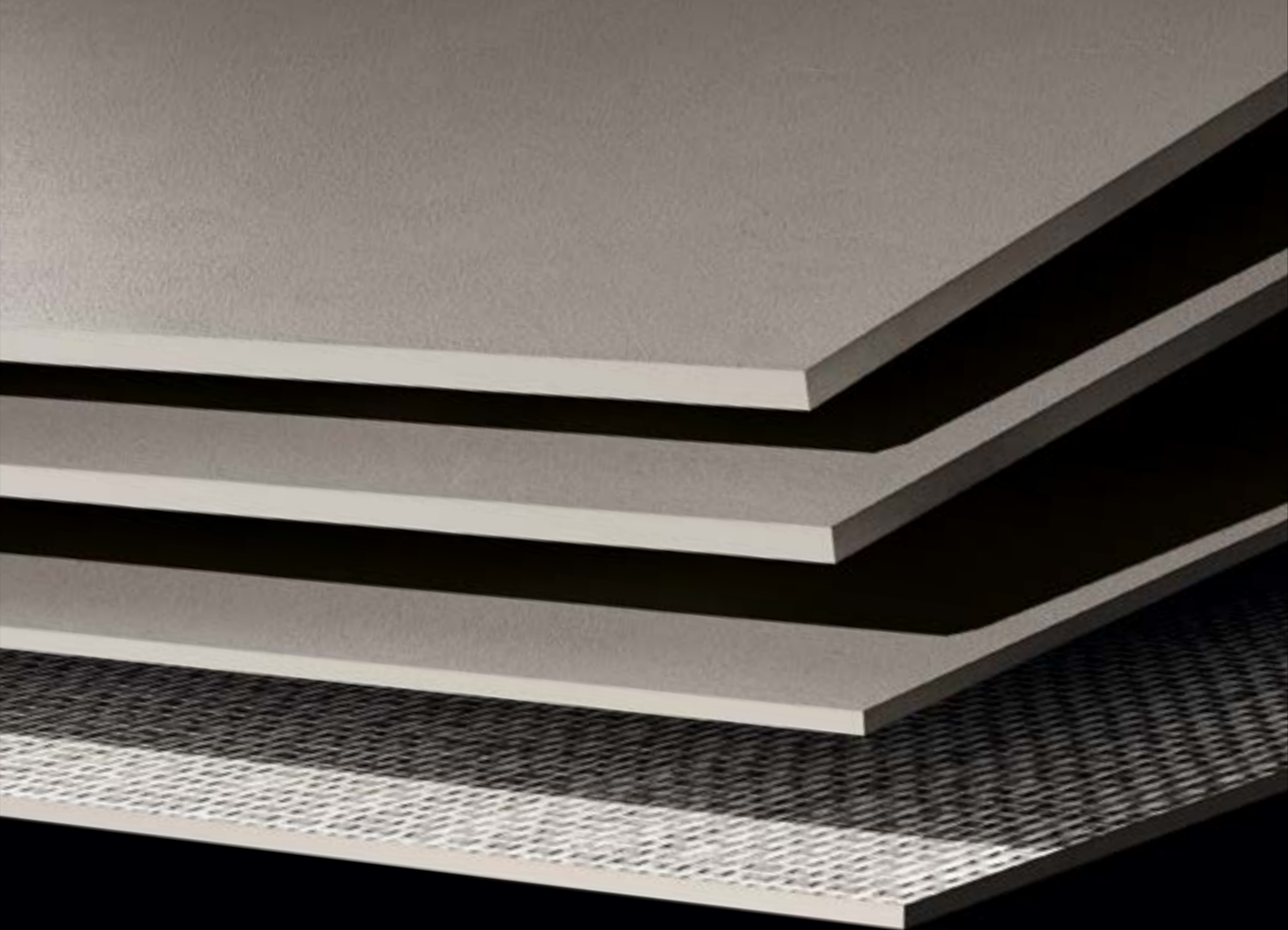

FORMATI
SIZES_FORMATE_FORMATS

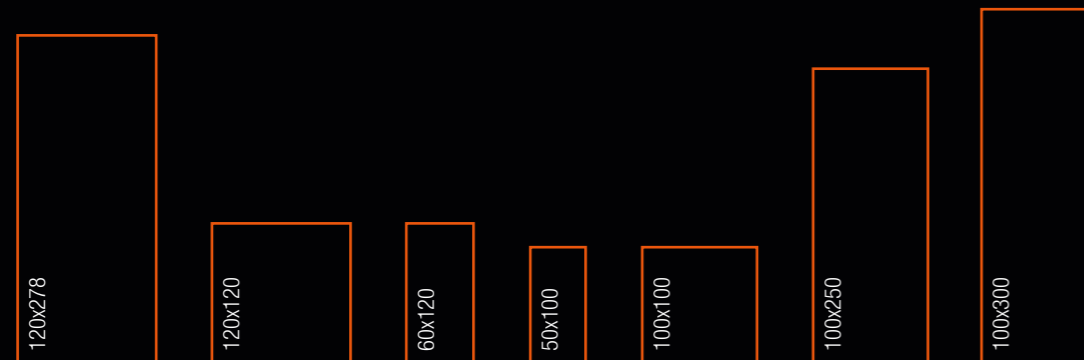

ZERO.3

± 6 mm

SOTTILE E RESISTENTE
THIN AND RESISTANT
DÜNN UND WIDERSTANDSFÄHIG
FIN ET RÉSISTANT

ZERO.3 PLUS

± 3,5 mm - 5,5 mm

ULTRASOTTILE E ULTRARESISTENTE. CON RINFORZO IN FIBRA DI VETRO
ULTRA-THIN AND ULTRA-RESISTANT. WITH FIBREGLASS MESH REINFORCEMENT
ULTRADÜNN UND ULTRAWIDERSTANDSFÄHIG MIT GLASFASERVERSTÄRKUNG
ULTRA FIN ET ULTRA RÉSISTANT AVEC RENFORT EN FIBRE DE VERRE

Zero.3

Lastre ceramiche sottili di qualità superiore

Superior quality thin ceramic slabs
Dunne hochwertige Keramikplatten
Dalles céramiques fines de qualité supérieure

Gres porcellanato laminato in grande formato:
un materiale leggero, versatile e resistente
per nuove prospettive progettuali nel mondo
dell'architettura e dell'abitare.

Large-sized laminated porcelain stoneware:
a light, resistant and versatile product for new design
perspectives in the world of architecture and housing.

Großformatiges laminiertes Feinsteinzeug:
ein leichtes, vielseitiges und widerstandsfähiges
Material für Design-Perspektiven in der Welt der
Architektur und des Wohnens.

Grès cérame laminé en grand format :
un matériau léger, polyvalent et résistant pour de
nouvelles perspectives conceptuelles dans le monde
de l'architecture et de l'habitat.

MASSIMI STANDARD QUALITATIVI E PRESTAZIONALI
Grazie all'utilizzo di materie prime pregiate.

LASTRE SUPERCOMPATTE ED ELASTICHE
Grazie a un processo di pressatura unico.

ECCELLENTE RESA ESTETICA DEI MATERIALI
*Grazie a tecniche esclusive di lavorazione delle
superfici.*

STRAORDINARIA EXTRA-RESISTENZA
Grazie al rinforzo in fibra di vetro.

ALTA SOSTENIBILITÀ AMBIENTALE
*Meno materie prime utilizzate, minor consumo di
acqua ed energia, minori emissioni di CO₂.*

HIGHEST STANDARDS IN QUALITY AND PERFORMANCE
Thanks to the use of the best raw materials.

HIGHLY COMPACT AND ELASTIC SLABS
Thanks to a unique pressing process.

EXCELLENT AESTHETIC LOOK OF THE PRODUCTS
Thanks to exclusive surface processing technologies.

EXTRAORDINARY ADDED RESISTANCE
Thanks to the reinforcing fibreglass mesh.

HIGHLY ECO-FRIENDLY
*Less raw materials used, lower water and energy
consumption and lower CO₂ emissions.*

HÖCHSTE QUALITÄTS- UND LEISTUNGSSTANDARDS
Dank der Verwendung von hochwertigen Rohstoffen.

SUPERKOMPATTE UND ELASTISCHE PLATTEN
Dank eines einzigartigen Pressvorgangs.

AUSGEZEICHNETE ÄSTHETIK DER MATERIALIEN
*Dank der exklusiven Bearbeitungstechniken der
Oberflächen.*

AUSSERGEWÖHNLICHE EXTRA-FESTIGKEIT
Dank der Verstärkung aus Glasfaser.

HOHE NACHHALTIGKEIT
*Geringer Rohstoffverbrauch, weniger Wasser- und
Energieverbrauch sowie weniger CO₂-Emissionen.*

CRITERES TRÈS ÉLEVÉS DE QUALITÉ ET DE PERFORMANCE
Grâce à l'utilisation de matières premières précieuses.

DALLES SUPER COMPACTES ET ÉLASTIQUES
Grâce à un processus de pressage unique.

EXCELLENT RENDU ESTHÉTIQUE DES MATÉRIAUX
*Grâce à des techniques exclusives de production des
surfaces.*

EXTRAORDINAIRE EXTRA-RESISTANCE
Grâce au renfort en fibre de verre.

HAUTE DURABILITÉ ENVIRONNEMENTALE
*Moins de matières premières utilisées, moins de
consommation d'eau et d'énergie, moins d'émissions de CO₂.*



Zero.3

Rinnovare senza demolire

Renovations without demolition
Renovieren ohne demolieren
Rènovier sans démolir

Le lastre ceramiche sottili sono ideali per rinnovare senza demolire. Possono essere posate in sovrapposizione al pavimento esistente con benefici di velocità, comodità, risparmio e assenza di detriti. È così possibile dunque ristrutturare uno spazio in modo altamente sostenibile, considerando, oltre alle caratteristiche del gres porcellanato laminato, anche l'elevato impatto nella generazione complessiva di rifiuti che normalmente hanno gli scarti di natura edilizia.

Thin ceramic slabs are perfect for renovating without demolishing. They can be installed on top of existing floors, providing the benefit of speed, convenience, savings, and absence of debris. Therefore, it is possible to renovate a space in a highly sustainable way, taking into account not only the characteristics of laminated porcelain stoneware, but also the enormous impact which construction debris usually has on the overall creation of waste.

Dünne Keramikplatten sind ideal zum Renovieren ohne Abbrucharbeiten. Sie können über dem vorhandenen Bodenbelag verlegt werden: schnell, einfach, kostengünstig und ohne Bauschutt. Die Renovierung eines Raums ist umso nachhaltiger, wenn neben den Merkmalen des laminierten Feinsteinzeugs an sich auch berücksichtigt wird, welcher großen Anteil Bauschutt normalerweise an der Abfallerzeugung im Ganzen hat.

Les dalles en céramique fine sont parfaites pour rénover sans démolir. Pouvant être superposées au sol existant, elles constituent une solution rapide, pratique et économique, le tout sans le moindre débris. Ainsi, il est possible de rénover un espace de façon très durable, si l'on considère, outre les caractéristiques propres au grès cérame laminé, l'impact considérable qu'a, d'ordinaire, la production totale de déchets provenant du bâtiment.



Zero.3



thinkzero.panariagroup.it

LA SUPERFICIE CERAMICA PIÙ SOSTENIBILE

The most sustainable ceramic surface
Die nachhaltigste Keramikoberfläche
La surface en céramique plus durable

CO₂ NEUTRAL

THINK ZERO È LA RIVOLUZIONE CHE DANDOVÌ DI MENO VI DÀ DI PIÙ

Le lastre ceramiche ultrasottili riducono la distanza tra noi e l'impatto zero perché riducono tutto quello che c'è nel mezzo.

THINK ZERO IS THE REVOLUTION THAT GIVES YOU LESS TO GIVE YOU MORE

The ultra-thin ceramic slabs reduce the gap between us and a zero impact reality thus reducing everything in between.

THINK ZERO IST DIE REVOLUTION NACH DEM PRINZIP „WENIGER IST MEHR“

Die hauchdünnen Keramikplatten bringen uns der Klimaneutralität ein großes Stück näher, weil sie alles reduzieren, was dazwischen liegt.

THINK ZERO EST LA RÉVOLUTION QUI EN VOUS DONNANT MOINS VOUS DONNE D'AVANTAGE

Les dalles en céramique ultra fin réduisent la distance entre nous et l'incidence zéro car elles réduisent tout ce qui se trouve au milieu.



NON SOLO MENO SPESSORE

ridotto fino ad un massimo di 3 mm.

LESS THICKNESS
to maximum 3 mm.

NICHT NUR WENIGER STÄRKE
auf maximal 3 mm reduziert.

PAS SEULEMENT MOINS D'ÉPAISSEUR
réduite jusqu'à un maximum de 3 mm.

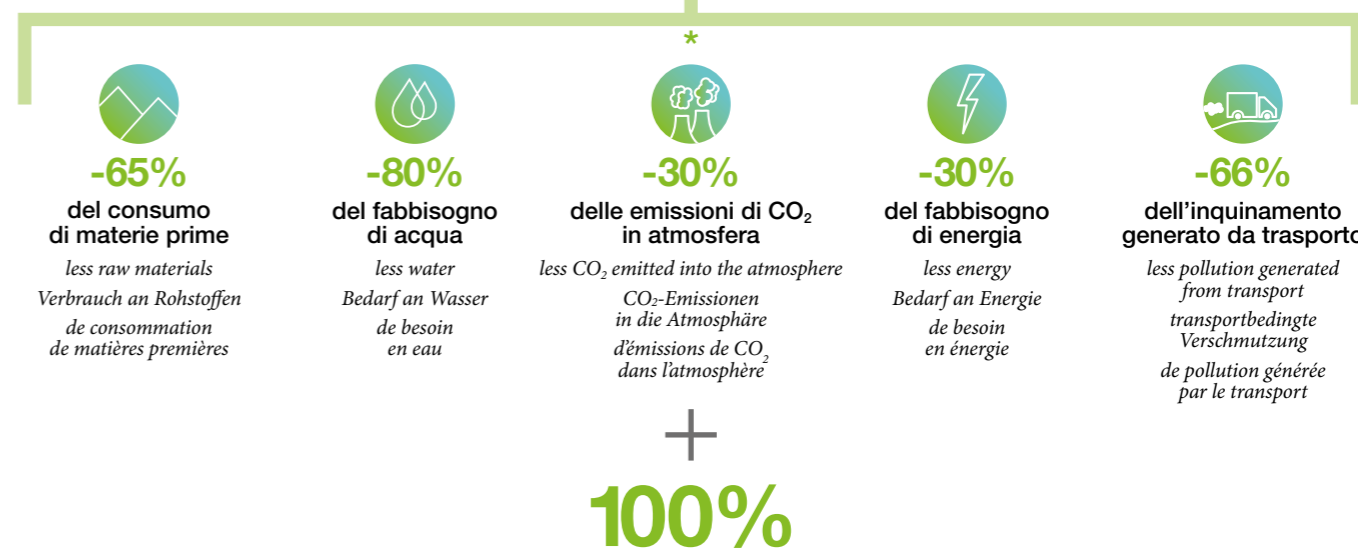

DELLE EMISSIONI DI CO₂ COMPENSATE (13,14 kg/mq)

Alta resistenza, alte prestazioni, massima sostenibilità e nessun compromesso.

COMPENSATION OF CO₂ EMISSIONS (13.14 kg/sqm)

High resistance, outstanding performance, ultimate sustainability and no compromises.

DER CO₂-EMISSIONEN AUSGEGLICHEN (13,14 kg/m²)

Hohe Widerstandsfähigkeit, hohe Leistungen, maximale Nachhaltigkeit und keine Kompromisse.

DES ÉMISSIONS DE CO₂ COMPENSÉES (13,14 kg/m²)

Résistance élevée, performances de haut niveau, maximum de durabilité et aucun compromis.

* I dati fanno riferimento a un prodotto a spessore sottile, confrontato con un grès porcellanato di spessore tradizionale. / The data refers to ultra-thin slabs when compared to standard-thickness porcelain stoneware tile. / Die Daten beziehen sich auf ein Produkt mit dünner Stärke, im Vergleich zu einem Feinsteinzeug mit herkömmlicher Stärke. / Les données sont celles d'un produit de faible épaisseur, comparé à un grès cérame d'épaisseur traditionnelle.



20 mm

Gres porcellanato 20 mm per outdoor

20 mm porcelain stoneware for outdoor
20 mm Feinsteinzeug für das Outdoor
Grès cérame 20 mm pour l'extérieur

Il gres porcellanato 20 mm è il prodotto a massima prestazione tecnica ideale per ambienti esterni, senza rischio di rotture.

20 mm porcelain stoneware has the highest technical performance of any product and is perfect for outdoor spaces, with no risk of breakage.

RESISTENTE E FUNZIONALE

Elevata resistenza meccanica e allo scivolamento, altissima resistenza ai carichi di rottura.

FACILE E VERSATILE

Semplice da installare, rimuovere e riutilizzare; facile da pulire. Carrabile quando incollato su massetto.

UNA SUPERFICIE ETERNA

Materia e colori stabili nel tempo, eccezionale resistenza alle macchie.

ADATTO AD OGNI UTILIZZO IN ESTERNO

Ingelivo e ignifugo, resiste a qualsiasi agente atmosferico, agli sbalzi termici, agli acidi, alle muffe e al sale. Abbinabile ai prodotti da interno per un perfetto coordinamento estetico senza interruzioni.

ECOLOGICO

Creato nel rispetto e per la salvaguardia dell'ambiente.

RESISTANT AND FUNCTIONAL

Superior mechanical strength and slip resistance, highly resistant to heavy loads.

EASY AND VERSATILE

Simple to install, remove and reuse; easy to clean. Resistant to vehicular passage when applied to a screed with adhesives.

AN ETERNAL SURFACE

The product and its colors remain stable over time and are highly resistant to stains.

SUITABLE FOR ALL OUTDOOR USE

Resistant to frost, fire, atmospheric agents, thermal shock, acids, mold and salt. Can be combined with products for interior spaces seamlessly and without interruptions.

ECO-FRIENDLY

Manufactured in a way which respects and protects the environment.

Das Feinsteinzeug mit 20 mm ist das Produkt mit maximaler technischer Leistung, das sich ohne Bruchgefahr ideal für Außenbereiche eignet.

Le grès cérame de 20 mm est le produit offrant le maximum de performance technique, idéal pour les espaces extérieurs, sans risque de rupture.

BESTÄNDIG UND ZWECKMÄSSIG

Hohe Festigkeit und Rutschsicherheit, sehr hohe Beständigkeit gegen Bruchlasten.

EINFACH UND VIELSEITIG

Einfaches Verlegen, Entfernen und Wiederverwenden; leichte Reinigung. Befahrbar bei Verkleben auf Estrich.

EINE UNVERWÜSTLICHE OBERFLÄCHE

Material und Farben bleiben im Lauf der Zeit stabil, herausragende Fleckenbeständigkeit.

GEEIGNET FÜR ALLE ANWENDUNGEN IM FREIEN

Frost- und feuerbeständig, beständig gegen alle möglichen Witterungseinflüsse, gegen Temperaturschwankungen, Säuren, Schimmel und Salz. Kombinierbar mit Produkten für den Innenbereich für eine perfekte ästhetische Abstimmung ohne Unterbrechungen.

UMWELTFREUNDLICH

Herstellung unter Beachtung und zum Schutz der Umwelt.

RÉSISTANT ET FONCTIONNEL

Haute résistance mécanique et antidérapante, très haute résistance aux charges de rupture.

FACILE ET POLYVALENT

Facile à installer, enlever et réutiliser; facile à nettoyer. Carrossable s'il est collé sur une chape.

UNE SURFACE ÉTERNELLE

Matière et coloris stables dans le temps, exceptionnelle résistance aux taches.

CONVIENT À TOUTE UTILISATION EN EXTÉRIEUR

Résistant au gel et ignifuge, il résiste à tous les agents atmosphériques, aux changements de température, aux acides, aux moisissures et au sel. Combinable avec les produits pour intérieur pour une parfaite coordination esthétique sans interruptions.

ÉCOLOGIQUE

Créé dans le respect et la protection de l'environnement.

FORMATI
SIZES_FORMATE_FORMATS

60x120

40x120

30x120

60x90

45x90

60x60

± 20 mm



soluzioni
decorative

Accenti preziosi per progetti coordinati

Exquisite details for coordinated projects
Kostbare Akzente für koordinierte Projekte
De précieux accents pour des projets coordonnés

Le collezioni Panaria si arricchiscono di decorazioni ricercate per applicazioni raffinate a rivestimento e a pavimento, capaci di dare uno stile e una personalità esclusiva ai vostri ambienti.

The Panaria collections are enhanced with refined decorations for sophisticated applications on floor and wall coverings, lending a unique style and personality to your rooms.

MASSIMA VERSATILITÀ DI SOLUZIONI

Da scoprire in un'ampia gamma di formati e varianti creative.

STILE MADE IN ITALY PER DECORAZIONI ESCLUSIVE

Curate in ogni minimo dettaglio per spazi sofisticati e contemporanei.

PROGETTI COORDINATI E INTEGRATI

Grazie all'abbinamento tra pavimenti e rivestimenti in gres porcellanato, gres porcellanato laminato o monoporosa in pasta bianca smaltata.

MIX & MATCH DI DECORI E SUPERFICI

Armonia di effetti materici differenti per composizioni creative, in tonalità o a contrasto, trasversali a ogni tipologia di ambiente.

SOLUTIONS THAT OFFER MAXIMUM VERSATILITY

Discover a wide range of sizes and creative variants.

MADE IN ITALY STYLE FOR EXCLUSIVE DECORATIONS

Sophisticated, contemporary spaces with meticulous attention to detail.

COORDINATED AND INTEGRATED PROJECTS

Thanks to the combination of matching wall and floor porcelain stoneware, laminated porcelain stoneware or glazed white body single-fired tiles.

MIX & MATCH OF DECORATIONS AND SURFACES

Different harmonious tactile effects for creative compositions that match or contrast and that are suited to any kind of room.

Die Panaria Kollektionen werden durch ausgesuchte Dekos für erlesene Verkleidungen oder Fußböden ergänzt, die Ihren Ambiente einen exklusiven Stil und eine ganz eigene Persönlichkeit geben.

Les collections Panaria se sont enrichies de décors raffinés pour des applications murales et au sol raffinées, capables de donner un style et une personnalité exclusifs à vos pièces.

ABSOLUT VIELSEITIGE LÖSUNGEN

Durch eine umfangreiche Auswahl an Formaten und kreativen Varianten.

MADE IN ITALY STIL FÜR EXKLUSIVE DEKORATIONEN

Für raffinierte und moderne Räume bis ins kleinste Detail.

KOORDINIERT UND INTEGRIERTE PROJEKTE

Durch die Kombination von Fußböden und Verkleidungen aus Feinsteinzeug, laminiertem Feinsteinzeug oder glasierte Weißschärbige wandfliese.

MIX & MATCH VON DEKOS UND OBERFLÄCHEN

Harmonie zwischen verschiedenen Materialeffekten für kreative Ton-in-Ton- oder Kontrast-Kompositionen in allen Typen von Ambiente.

POLYVALENCE MAXIMALE DES SOLUTIONS

A découvrir dans une large gamme de formats et de variations créatives.

FABRIQUÉ EN STYLE ITALIEN POUR DES DÉCORATIONS EXCLUSIVES

Grâce à un processus de pressage unique.

DES PROJETS COORDONNÉS ET INTÉGRÉS

Grâce à l'association entre des sols et des revêtements en grès cérame, grès cérame laminé ou faïences pâte blanche émaillé.

MIX & MATCH DE DÉCORS ET DE SURFACES

Harmonie de différents effets matériques pour des compositions créatives, en nuances ou en contrastes, transversales à chaque type d'environnement.

Il nostro Gruppo



Our Group_ Unsere Unternehmensgruppe_ Notre Groupe



Panariagroup

Nel tempo e nel mondo l'eccellenza ceramica

Throughout time and around the world, ceramic excellence
Keramische Spitzenleistungen im Laufe der Zeit und Weltweit
Dans le temps et dans le monde, l'excellence céramique

Eccellere, nel mondo della ceramica di alta qualità, significa saper generare sempre prodotti a elevata componente tecnologica e impreziosirli con la massima attenzione estetica, con la cura di ogni dettaglio. Per soddisfare al meglio i gusti della fascia più elevata ed esigente del mercato, Panariagroup adotta da sempre la formula dell'eccellenza, unendo storica sapienza artigianale e attitudine all'avanguardia tecnologica. Con un impegno fondamentale ad agire e operare sempre con responsabilità. Con oltre 40 anni di esperienza, Panariagroup è oggi una realtà internazionale con un cuore fortemente italiano, presente con 9 brand in oltre 130 paesi nel mondo grazie a una vasta e capillare rete commerciale.

To excel in the world of high quality ceramics means knowing how to continuously create highly technological products and how to enhance them through the utmost attention to aesthetics and detail. Panariagroup has always adhered to the highest standards of excellence, combining its history of skilful artisan craftsmanship with cutting edge technology. This approach is intrinsically linked to a fundamental commitment to always act and operate responsibly. With over 40 years of experience, Panariagroup is an international company with a strong Italian soul and an extensive sales network with 9 brands in over 130 countries all over the world.

Sich in der Welt der hochwertigen Keramik hervorzuheben, bedeutet, immer in der Lage zu sein, Produkte mit einer hohen technologischen Komponente zu erzeugen und sie mit größter Aufmerksamkeit für Ästhetik und mit Liebe zum Detail zu verschönern. Um den Geschmack des höchsten und anspruchsvollsten Marktsegments bestmöglich zu befriedigen, hat Panariagroup immer die Formel der Spitzenleistung gewählt, mit der Verbindung der historischen Handwerkskunst und technologischen Avantgarde. Mit der grundlegenden Verpflichtung, stets verantwortungsbewusst zu handeln und zu operieren. Mit mehr als 40 Jahren Erfahrung ist die Panariagroup heute eine internationale Realität mit einem starken italienischen Herzen, die dank eines breiten und kapillaren Vertriebsnetzes mit 9 Marken in mehr als 130 Ländern weltweit präsent ist.

Exceller, dans le monde de la céramique de haute qualité, signifie toujours savoir créer des produits à composante technologique élevée et les enrichir avec la plus grande attention esthétique, en soignant tous les détails. Pour satisfaire au mieux les goûts du segment le plus élevé et le plus exigeant du marché Panariagroup adopte depuis toujours la formule de l'excellence, unissant la connaissance historique artisanale et l'attitude technologiquement à l'avant-garde. Avec un engagement fondamental à agir et œuvrer toujours de manière responsable. Avec plus de 40 ans d'expérience, Panariagroup est aujourd'hui un groupe international avec un cœur fortement italien, présent avec 9 marques dans plus de 130 pays dans le monde, grâce à un vaste réseau commercial.



Panariagroup

Ceramiche per la qualità della vita

Ceramics for the quality of your life
Keramik für die Qualität ihres Lebens
La céramique pour la qualité de votre vie

PIÙ SANE

Grazie all'esclusiva protezione antibatterica Protect.*

PIÙ SOSTENIBILI

Con le lastre sottili a impatti minimi e CO₂ neutral.

HEALTHIER

Thanks to the exclusive Protect antimicrobial protection.*

MORE SUSTAINABLE

With thin slabs having minimal impact and CO₂ neutral.

GESÜNDER

Dank dem exklusiven antibakteriellen Schutz Protect.*

NACHHALTIGER

Mit den hauchdünnen CO₂-neutralen Platten mit minimalen Auswirkungen.

PLUS SAINES

Grâce à l'exclusive protection antibactérienne Protect.*

PLUS SOUTENABLES

Avec les dalles fines à impact minimal et CO₂ neutre.

Bellezza, Innovazione, Sostenibilità

Panariagroup è leader mondiale nei pavimenti e rivestimenti di alta qualità. Con processi produttivi che rispettano l'ambiente e prodotti pensati per un nuovo modo di concepire l'architettura e l'abitare.

Beauty, Innovation, Sustainability

Panariagroup is a world leader in high quality ceramic surfaces for floor and wall coverings. Its production processes respect the environment and its products are designed for a new way of conceiving architecture and living.

Schönheit, Innovation, Nachhaltigkeit

Panariagroup ist ein international führender Hersteller von qualitativ hochwertigen Wand- und Bodenbelägen. Die Produktion erfolgt umweltschonend, und die Produkte sind auf ein neues Konzept des Bauens und Wohnens ausgelegt.

Esthétique, Innovation, Durabilité

Panariagroup, leader mondial des sols et revêtements de haute qualité garantit des processus de production respectueux de l'environnement et des produits conçus pour envisager l'architecture et le logement différemment.

Consulta il nostro Bilancio di Sostenibilità, scaricandolo dal sito panariagroup.it o richiedendolo via mail a sustainability@panariagroup.it

Check our Sustainability Report, downloading it from the panariagroup.it site or requesting it via email at sustainability@panariagroup.it

Lesen Sie unsere Nachhaltigkeitsbilanz, indem Sie sie entweder von der Seite panariagroup.it herunterladen oder via E-Mail unter sustainability@panariagroup.it anfordern.

Consultez notre Bilan de durabilité, en le déchargeant sur le site panariagroup.it ou en le demandant par e-mail à sustainability@panariagroup.it



LA CERAMICA. UNA SCELTA SICURA.

CERAMICS. A SAFE CHOICE. / KERAMIK. EINE SICHERE WAHL. / LA CÉRAMIQUE, UN CHOIX SÛR.



SICURA
SAFE / SICHER / SÛRE

IGIENICA
HYGIENIC / HYGIENISCH / HYGIÉNIQUE

DURA A LUNGO
LONG-LASTING / LANGLEBIG / DURE LONGTEMPS

NON EMETTE SOSTANZE CHIMICHE NOCIVE
ZERO VOCs / NULL VOCs / ZERO COV

NON BRUCIA
IT DOES NOT BURN / BRENNT NICHT/ NE BRÛLE PAS

RESISTENTE
RESISTANT / BESTÄNDIG / RÉSISTANTE

VERSATILE
VERSATILE / VIELSEITIG / POLYVALENTE

STABILE
STABLE / STABIL / STABLE

RICICLABILE
RECYCLABLE / WIEDERVERWERTBAR / RECYCLABLE

AMA L'AMBIENTE
ENVIRONMENT-FRIENDLY / UMWELTSCHONEND / RESPECTE L'ENVIRONNEMENT

Panariagroup La ceramica nella sua forma migliore

Ceramics at their best
Keramik in ihrer besten Form
La céramique sous sa meilleure forme

La ceramica è un materiale dalle prestazioni uniche e straordinarie.
Panariagroup si distingue con prodotti di qualità superiore.

Ceramics offer unique and outstanding performance.
Panariagroup stands out for its superior quality products.

PIÙ SALUBRI
Grazie all'integrazione della tecnologia antibatterica Protect®.

PIÙ FACILI DA PULIRE
Grazie alle nostre esclusive tecniche di lavorazione delle superfici.

PIÙ VERSATILI E ADATTI AD OGNI IMPIEGO
Grazie ad un'ampia disponibilità di tecnologie e componenti ad elevata performance che consentono di ottenere prodotti adatti a destinazioni d'uso differenti.

PIÙ SOSTENIBILI
Grazie a un processo produttivo estremamente efficiente in termini di rispetto delle norme ambientali, del consumo di acqua, energia e materie prime.

HEALTHIER
Thanks to the integrated Protect® antimicrobial technology.

EASIER TO CLEAN
Thanks to our exclusive surface processing techniques.

MORE VERSATILE AND SUITABLE FOR EVERY USE
Thanks to the wide availability of high-performance technologies and components that allow you to obtain products suitable for different uses.

MORE SUSTAINABLE
Thanks to a production process that is extremely efficient in terms of compliance with environmental standards and consumption of water, energy and raw materials.

Keramik ist ein Material mit einzigartigen und ausgezeichneten Leistungen.
Panariagroup zeichnet sich durch ihre hochwertigen Qualitätsprodukte aus.

La céramique est un matériau aux performances uniques et extraordinaires.
Panariagroup se distingue par ses produits de qualité supérieure.

GESÜNDER
Dank der Integration der antibakteriellen Technologie Protect®.

EINFACHER ZU REINIGEN
Dank unserer exklusiven Verarbeitungstechniken der Oberflächen.

VIELSEITIGER UND FÜR JEDEN EINSATZ GEEIGNET
Dank einer breiten Verfügbarkeit von Technologien und Komponenten mit hoher Leistung, die es ermöglichen, Produkte für verschiedene Einsatzbereiche zu erhalten.

NACHHALTIGER
Dank einem extrem effizienten Produktionsprozess im Hinblick auf Einhaltung der Umweltnormen, sowie Wasser-, Strom- und Rohstoffverbrauch.

PLUS SAINS
Grâce à l'intégration de la technologie antibactérienne Protect®.

PLUS FACILES À NETTOYER
Grâce à nos techniques exclusives de traitement de surface.

PLUS POLYVALENTS ET ADAPTÉS À TOUS LES USAGES
Grâce à une vaste disponibilité de technologies et de composants à haute performance, qui permettent d'obtenir des produits adaptés à des usages différents.

PLUS DURABLES
Grâce à un processus de production extrêmement efficace en termes de respect des normes environnementales, de consommation d'eau, d'énergie et de matières premières.

Le collezioni



Collections_Kollektionen_Collections

La bellezza di poter scegliere la superficie ideale

The beauty of being able to choose the perfect surface
Die Schönheit, die ideale Oberfläche wählen zu können
La beauté de pouvoir choisir la surface idéale

Le collezioni Panaria offrono un'ampia gamma di superfici ispirate a elementi naturali e a suggestivi effetti materici, pensate per incontrare una molteplicità di stili e gusti differenti.

The Panaria collections offer a wide range of surfaces inspired by natural elements and striking material effects, designed to satisfy a variety of different styles and tastes.

Die Panaria Kollektionen bieten eine große Auswahl an Oberflächen an, die an natürlichen Elementen und an suggestiven Materialeffekten inspiriert sind und entwickelt wurden, um zahlreichen verschiedenen Stilen und Geschmacksrichtungen gerecht zu werden.

Les collections Panaria offrent une large gamme de surfaces inspirées d'éléments naturels et d'effets matériels évocateurs, conçues pour répondre à une grande variété de styles et de goûts.



Effetto pietra
Stone look
Stein-Optik
Effet pierre

Effetto cemento
Concrete look
Zement-Optik
Effet ciment

Effetto marmo
Marble look
Marmor-Optik
Effet marbre

Effetto legno
Wood look
Holz-Optik
Effet bois

Effetto cromatico
Chromatic look
Chromatischer Effekt
Effet chromatique

Legenda

Legend_Legende_Légende

Simbologia

Key to symbols_Symbole_Symbologie



Pavimento

Floor
Bodenbelag
Revêtement de sol



Rivestimento

Wall
Wandverkleidung
Revêtement de mur



Spessore

Thickness
Stärke
Épaisseur



Resistenza allo scivolamento

Slip resistance
Rutschfestigkeit
Résistance au glissement



Resistenza all'abrasione profonda

Deep abrasion resistant
Widerstand gegen Tiefenabrieb
Résistance à l'abrasion profonde

Grado di stonalizzazione

Shade variation_Abtönungsgrad_Degré de variabilité chromatique



V0 - Aspetto molto uniforme.

V0 - Very uniform appearance
V0 - Sehr gleichmäßiges Aussehen
V0 - Aspect très uniforme

V1 - Aspetto uniforme

V1 - Uniform appearance
V1 - Gleichmäßiges Aussehen
V1 - Aspect uniforme

V2 - Variazioni minime

V2 - Slight variation
V2 - Minimale Variationen
V2 - Variations minimales

V3 - Variazioni moderate

V3 - Moderate variation
V3 - Mäßige Variationen
V3 - Variations modérées

V4 - Variazioni sostanziali

V4 - Substantial variation
V4 - Wesentliche Variationen
V4 - Variations importantes

Decori

Decors_Dekore_Decors

CHEVRON:

Questi formati speciali vengono realizzati con un sistema di taglio a disco senza bisello. L'eventuale presenza di leggere irregolarità del bordo e di scostamenti dimensionali fino ad 1 mm sono da ritenersi conformi

These special formats are produced with a disc cutting system without a bevel. Any slight irregularities of the edge and size deviations of up to 1 mm should be regarded as compliant
Diese Sonderformate werden mit einem Scheibenschnittsystem ohne Fase hergestellt. Eventuelle leichte Unregelmäßigkeiten an der Kante und Größenabweichungen bis zu 1 mm sind als konform anzusehen
Ces formats spéciaux sont réalisés avec une système de découpe à disque sans biseau. L'éventuelle présence de légères irrégularités du bord et de différences de dimension jusqu'à 1 mm est tout à fait conforme

Pezzi speciali

Trim pieces_Spezialteile_Pièces spéciales

Trattandosi di pezzi artigianali possono verificarsi piccole variazioni dimensionali

Handmade pieces: light size variations may occur
Da es sich um handgemachte Teile handelt, können es kleine dimensionale Veränderungen auftreten
Étant donné qu'il s'agit de pièces faites à la main il peut y avoir des petits changements dimensionnels

PEZZI SPECIALI_TRIM PIECES_SPEZIALTEILE_PIECES SPECIALES 20 MM:

Venduti solo a scatole complete, lavorati solo su richiesta, consegna 30 gg

Only full boxes sold, manufactured only upon special request, 30 days delivery
Nur als komplette Kartons verkauft, nur auf Anfrage verarbeitet, Lieferzeit 30 Tage
Vendus uniquement par boîte complète, produits uniquement à la demande, livraison 30 jours

Imballaggi e pesi

Packings and weights_Verpackungen und Gewichte_Emballages et poids

Tutti i dati relativi gli imballi indicati nel presente catalogo sono da ritenersi puramente indicativi e potrebbero subire variazioni

All information regarding packaging in this catalogue are considered purely indicative and subject to change
Die Angaben diesen Verpackungen sind rein indikativ und koennen veraendert werden
Les valeurs des emballages déclarées sur ce catalogue sont purement indicatives et elles pourront être modifiées

Destinazioni d'uso

Intended use_Einsatzbereiche_Utilisations prévues



RESIDENZIALE_RESIDENTIAL_WOHNBEREICH_RÉSIDENTIEL

Cucine, bagni, living e ogni altro ambiente di uso residenziale.
Kitchens, bathrooms, living rooms and other residential environments.
Küchen, Badezimmer, Wohnzimmer und alle sonstigen Wohnbereiche.
Cuisines, salles de bains, salons et tout autre espace à usage résidentiel.



COMMERCIALE LEGGERO_LIGHT COMMERCIAL

LEICHTE GEWERBLICHE ANWENDUNGEN_COMMERCIAL LÉGER

Uffici, uffici aperti al pubblico, sale d'attesa, negozi, bagni pubblici, aree comuni condominiali, sale di ristoranti, autosaloni, bar, cinema, ambulatori/cliniche, camere e bagni di hotel. In aree caratterizzate da passaggi obbligati, o dove è previsto l'utilizzo di sedie con ruote in plastica dura, non è consigliato l'utilizzo di prodotti con finitura LUX.

Offices, offices open to the general public, waiting rooms, shops, public bathrooms, common apartment block areas, restaurant dining rooms, car showrooms, bars, cinemas, surgeries/clinics, hotel rooms and bathrooms. In areas subjected to forced traffic, or areas where chairs with hard plastic wheels are used, it is not advisable to use products with the LUX finishes.

Büroräume, öffentliche Büros, Wartezimmer, Geschäfte, öffentliche Toiletten, Gemeinschaftsbereiche in Mehrfamilienhäusern, Gaststätten, Autohäusern, Cafés, Kinos, Praxen/Kliniken, Hotelzimmern und Badezimmern. In Bereichen mit obligatorischen Durchgängen oder in denen Stühle mit Hartplastikrollen verwendet werden, ist der Einsatz von Produkten mit den Oberflächen LUX nicht zu empfehlen.

Bureaux, bureaux ouverts au public, salles d'attente, magasins, toilettes publiques, espaces communs de logements collectifs, salles de restaurants, salons automobiles, bars, cinémas, cabinets médicaux/cliniques, chambres et salles de bains d'hôtels. Dans les zones caractérisées par des passages obligatoires, ou des lieux dans lesquels des chaises à roulettes en plastique dur sont utilisées, l'utilisation de produits avec une finition LUX n'est pas recommandée.

Note

Notes_Anmerkungen_Remarques

FINITURA LUX: la finitura LUX è consigliata, oltre che per rivestimenti, anche per pavimenti in ambienti residenziali o commerciale leggero non sottoposti ad elevate sollecitazioni, ove non siano richieste prestazioni antiscivolo. La presenza sporadica di piccole disuniformità o di puntini sulla superficie è da ritenersi come caratteristica del materiale e della particolare lavorazione. Qualora il prodotto sia posto a diretto contatto con l'esterno, si consiglia di utilizzare soluzioni protettive al fine di prevenire la formazione di graffi. È responsabilità del posatore provvedere sempre alla protezione della piastrellatura finita e pulita, prima della consegna al committente, tramite appositi materiali protettivi (es. pannelli in truciolare, fogli di cartone, etc.).

LUX SURFACE FINISHES: the LUX finishes are recommended, as well as for wall cladding, also for flooring in residential or light commercial areas that are not subjected to heavy traffic, where anti-slip characteristics are not required. The occasional presence of small inconsistencies or little spots on the surface is to be considered a characteristic of the material and of its unique production process. If the product is laid in direct contact with external environments, it is recommended to use protective solutions to reduce scratches. It is the installer's responsibility to protect the finished and clean tiling before the delivery to the client, by using appropriate protective materials (e.g. chipboard, cardboard sheets, etc.).

LUX OBERFLÄCHE: die Oberfläche LUX wird nicht nur für Wandverkleidungen empfohlen, sondern auch für Böden in Wohn-bzw. Gewerbebereichen, die keiner hohen Belastung ausgesetzt sind und bei denen keine rutschhemmende Wirkung erforderlich ist. Das sporadische Vorhandensein von kleinen Unebenheiten oder Punkten auf der Oberfläche ist als ein Merkmal des Materials und der besonderen Verarbeitung zu betrachten. Wenn das Produkt in direktem Kontakt mit dem Außenbereich steht, ist es ratsam, Schutzmittel zu verwenden, um die Bildung von Kratzern zu verhindern. Der Fliesenleger ist dafür zuständig, den fertig verlegten, sauberen Fliesenbelag vor der Übergabe an den Bauherrn mit geeigneten Schutzmaterialien (z.B. Spanplatten, Pappe etc.) abzudecken.

FINITION LUX: en plus des revêtements, la finition LUX est également recommandée pour les sols dans les environnements résidentiels ou commerciaux légers peu soumis à des contraintes élevées, pour lesquels aucune prestation antidérapante n'est requise. La présence sporadique de petites irrégularités ou de points à la surface doit être considérée comme une caractéristique du matériau et de sa fabrication particulière. Si le produit est placé en contact direct avec l'extérieur, il est conseillé d'utiliser des solutions de protection afin d'éviter la formation de rayures. Il incombe au carreleur de protéger le dallage fini et propre avant la livraison au client, en utilisant des matériaux de protection appropriés (e.g. panneau aggloméré, feuille de carton etc.).

In aree caratterizzate dal passaggio di carichi pesanti concentrati non è consigliato l'utilizzo di prodotti a spessore ridotto.

In areas that are subjected to heavy concentrated loads it is not recommended to use low thickness products.
In Bereichen, die schwerer Belastung ausgesetzt sind, ist die Verwendung von Produkten mit reduzierter Stärke nicht empfehlenswert.
Dans les zones à passage de charges lourdes concentrées, l'utilisation de produits d'épaisseur réduite n'est pas recommandée.



Effetto pietra

Stone look_Stein-Optik_Effet pierre



Bioarch



BARGE GIALLA STRUTTURATO



BARGE GRIGIA STRUTTURATO

GRES PORCELLANATO A MASSA COLORATA_COLOURED-BODY PORCELAIN STONEWARE 

± 9 mm



20x41 cm
8"x16^{1/8}"



20x30,5 cm
8"x12"



20x20 cm
8"x8"

GRES PORCELLANATO A MASSA COLORATA_COLOURED-BODY PORCELAIN STONEWARE **20 mm** 

± 20 mm



60x60 cm Rect
24"x24"



PAVIMENTO / FLOOR Barge Grigia Strutturato 20x20 cm - 8"x8" _20x30,5 cm - 8"x12" _20x41 cm - 8"x16^{1/8}"



PAVIMENTO / FLOOR Barge Grigia Strutturato 60x60 cm Rect - 24"x24" 20 mm

BARGE GIALLA STRUTTURATO



BARGE GRIGIA STRUTTURATO



GRES PORCELLANATO A MASSA COLORATA_COLOURED-BODY PORCELAIN STONWARE





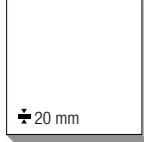

 9 mm	 9 mm	 9 mm
20x41 cm - 8"x16^{1/8}"	20x30,5 cm - 8"x12"	20x20 cm - 8"x8"
Barge Gialla Strutturato PGGBK05	Barge Gialla Strutturato PGGBK05	Barge Gialla Strutturato PGGBK05
Barge Grigia Strutturato PGGBK15	Barge Grigia Strutturato PGGBK15	Barge Grigia Strutturato PGGBK15

GRES PORCELLANATO A MASSA COLORATA_COLOURED-BODY PORCELAIN STONWARE **20 mm**

 20 mm
60x60 cm Rect - 24"x24"
Barge Gialla Strutturato PGWBKSO
Barge Grigia Strutturato PGWBKS1

DESTINAZIONI D'USO_INTENDED USE: **STRUTTURATO** 

DATI TECNICI_TECHNICAL DATA:

GRES PORCELLANATO A MASSA COLORATA COLOURED-BODY PORCELAIN STONWARE		GRES PORCELLANATO A MASSA COLORATA COLOURED-BODY PORCELAIN STONWARE	
9 mm		20 mm	
			
DIN EN 16165 - Annex B: R11 Strutturato	DIN EN 16165 - Annex B: R11 Strutturato	DIN EN 16165 - Annex B: R11 Strutturato	DIN EN 16165 - Annex B: R11 Strutturato
DIN EN 16165 - Annex A: C (A+B+C) Strutturato	DIN EN 16165 - Annex A: C (A+B+C) Strutturato	DIN EN 16165 - Annex A: C (A+B+C) Strutturato	DIN EN 16165 - Annex A: C (A+B+C) Strutturato
BCR TORTUS: $\mu > 0,40$ Strutturato	BCR TORTUS: $\mu > 0,40$ Strutturato	BCR TORTUS: $\mu > 0,40$ Strutturato	BCR TORTUS: $\mu > 0,40$ Strutturato
ANSI A326.3: EW Strutturato	ANSI A326.3: EW Strutturato	ANSI A326.3: EW Strutturato	ANSI A326.3: EW Strutturato
BS 7976-2: PTV 36+WET (SI.96 - SI.55) Strutturato	BS 7976-2: PTV 36+WET (SI.96 - SI.55) Strutturato	BS 7976-2: PTV 36+WET (SI.96 - SI.55) Strutturato	BS 7976-2: PTV 36+WET (SI.96 - SI.55) Strutturato
	EN 101: MOHS 9		CTI 81-7 ANNEX A: MOHS 9
	ANSI A137.1: V4 Strutturato		ANSI A137.1: V3 Strutturato

SOLUZIONI DI POSA_LAYING SOLUTIONS

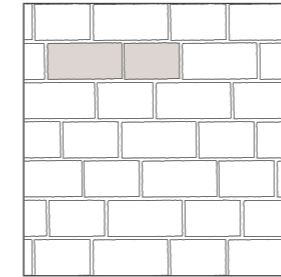

20x30,5 (42,66%) - 20x41 (57,34%)

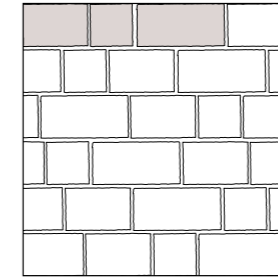

20x20 (21,86%) - 20x30,5 (33,33%)
20x41 (44,81%)

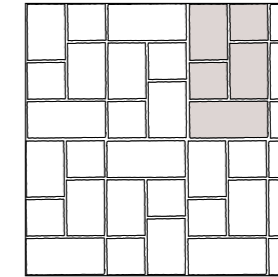

20x20 (28,17%) - 20x30,5 (42,96%)
20x41 (28,87%)

Fuga consigliata: vedi pag. 419_Suggested joint: see pag. 419_Empfohlene Fuge: siehe Seite 419_Joint conseillé : voir page 419

PEZZI SPECIALI_TRIM PIECES



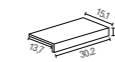





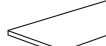

GRES PORCELLANATO A MASSA COLORATA_COLOURED-BODY PORCELAIN STONWARE

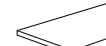

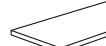

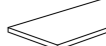



ELEMENTO "L"
15x30x4 cm - 6"x12"x1^{5/16}"
9 mm

BARGE GIALLA STRUTTURATO	PGZBKA0
BARGE GRIGIA STRUTTURATO	PGZBKA1

GRES PORCELLANATO A MASSA COLORATA_COLOURED-BODY PORCELAIN STONWARE **20 mm**

						
	COSTA TORO ANGOLARE DX 30x60 cm Rect - 12"x24"	COSTA TORO ANGOLARE SX 30x60 cm Rect - 12"x24"	COSTA TORO 30x60 cm Rect - 12"x24"	COSTA TORO GRIP 30x60 cm Rect - 12"x24"	COSTA RETTA ANGOLARE DX 30x60 cm Rect - 12"x24"	COSTA RETTA ANGOLARE SX 30x60 cm Rect - 12"x24"
BARGE GIALLA STRUTTURATO	PGDBKK2	PGDBKK0	PGDBKF0	PGDBKJ0	PGDBKD2	PGDBKD0
BARGE GRIGIA STRUTTURATO	PGDBKK3	PGDBKK1	PGDBKF1	PGDBKJ1	PGDBKD3	PGDBKD1
						
	COSTA RETTA 30x60 cm Rect - 12"x24"	COSTA RETTA GRIP 30x60 cm Rect - 12"x24"	GRIGLIA ANGOLARE DX 15x60 cm Rect - 6"x24"	GRIGLIA ANGOLARE SX 15x60 cm Rect - 6"x24"	GRIGLIA 15x60 cm Rect - 6"x24"	
BARGE GIALLA STRUTTURATO	PGDBKCO	PGDBKGO	PGDBKA2	PGDBKA0	PGDBKZO	
BARGE GRIGIA STRUTTURATO	PGDBKC1	PGDBKG1	PGDBKA3	PGDBKA1	PGDBKZ1	

IMBALLAGGI E PESI_PACKINGS AND WEIGHTS

DESCRIZIONE Description	9 mm	FORMATI Sizes	SCATOLA_Box				PALLET		
									
FONDO STRUTTURATO	9	20x41	13	21	1,066	-	54	1134	57,56
FONDO STRUTTURATO	9	20x30,5	20	23,1	1,22	-	48	1108,8	58,56
FONDO STRUTTURATO	9	20x20	30	25	1,2	-	45	1125	54
ELEMENTO "L" STRUTTURATO	9	15x30x4	8	9,6	0,36	2,4	48	460,8	17,28
FONDO STRUTTURATO	20	60x60 ^{RECT}	2	33	0,72	-	32	1056	23,04
COSTA TORO STRUTTURATO	20	30x60 ^{RECT}	1	8,125	0,135	-	100	812,5	13,5
COSTA TORO ANGOLARE STRUTTURATO	20	30x60 ^{RECT}	1	6,1	0,135	-	100	610	13,5
COSTA TORO GRIP STRUTTURATO	20	30x60 ^{RECT}	1	8,125	0,135	-	100	812,5	13,5
COSTA RETTA STRUTTURATO	20	30x60 ^{RECT}	1	8,125	0,135	-	100	812,5	13,5
COSTA RETTA ANGOLARE STRUTTURATO	20	30x60 ^{RECT}	1	6,1	0,135	-	100	610	13,5
COSTA RETTA GRIP STRUTTURATO	20	30x60 ^{RECT}	1	8,125	0,135	-	100	812,5	13,5
GRIGLIA STRUTTURATO	20	15x60 ^{RECT}	2	8	0,158	-	100	800	15,75
GRIGLIA ANGOLARE STRUTTURATO	20	15x60 ^{RECT}	2	7	0,158	-	100	700	15,75



Discover



WHITE



SUN



ORIGIN

GRES PORCELLANATO A MASSA COLORATA_COLOURED-BODY PORCELAIN STONEWARE



± 9 mm
± 9,5 mm



60x60 cm Rect
24"x24"



30x60 cm Rect
12"x24"
30x60,3 cm
12"x24"



20x60 cm Rect
8"x24"



15x60 cm Rect
6"x24"



7,5x60 cm Rect
3"x24"



5x60 cm Rect
2"x24"

GRES PORCELLANATO A MASSA COLORATA_COLOURED-BODY PORCELAIN STONEWARE **20 mm**



± 20 mm

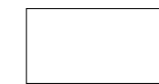

60x120 cm Rect
24"x48"



60x60 cm Rect
24"x24"



RIVESTIMENTO / WALL White Naturale 30x60 cm Rect - 12"x24" _Mosaico a sbalzo White Naturale 30x30 cm Rect - 12"x12"
PAVIMENTO / FLOOR Origin Naturale 60x60 cm Rect - 24"x24"



RIVESTIMENTO / WALL Origin Naturale 30x60 cm Rect - 12"x24" _20x60 cm Rect - 8"x24" _15x60 cm Rect - 6"x24"
PAVIMENTO / FLOOR Origin Naturale 60x60 cm Rect - 24"x24"



PAVIMENTO / FLOOR Sun Strutturato 30x60,3 cm - 12"x24"



PAVIMENTO / FLOOR White Strutturato 60x60 cm - 24"x24" 20 mm

Discover

PROTECT
ANTIBATTERICO - ANTIMICROBIAL

WHITE



SUN



ORIGIN



Discover

GRES PORCELLANATO A MASSA COLORATA_COLOURED-BODY PORCELAIN STONEWARE

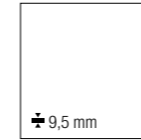

60x60 cm Rect - 24"x24"
White NATURALE PGWDI31P
Sun NATURALE PGWDI21P
Origin NATURALE PGWDI01P



30x60 cm Rect - 12"x24"
White NATURALE PG-DI31
Sun NATURALE PG-DI21
Origin NATURALE PG-DI01

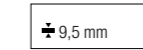

20x60 cm Rect - 8"x24"
White NATURALE PG2DI30
Sun NATURALE PG2DI20
Origin NATURALE PG2DI00

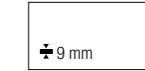

30x60,3 cm - 12"x24"
White STRUTTURATO* PG-DIS3
Sun STRUTTURATO* PG-DIS2
Origin STRUTTURATO* PG-DIS0



15x60 cm Rect - 6"x24"
White NATURALE PG1DI30
Sun NATURALE PG1DI20
Origin NATURALE PG1DI00



7,5x60 cm Rect - 3"x24"
White NATURALE PGRDI30
Sun NATURALE PGRDI20
Origin NATURALE PGRDI00



5x60 cm Rect - 2"x24"
White NATURALE PG0DI30
Sun NATURALE PG0DI20
Origin NATURALE PG0DI00

GRES PORCELLANATO A MASSA COLORATA_COLOURED-BODY PORCELAIN STONEWARE **20 mm**



60x120 cm Rect - 24"x48"
White STRUTTURATO* PGXDIS33
Sun STRUTTURATO* PGXDIS23
Origin STRUTTURATO* PGXDIS03



60x60 cm Rect - 24"x24"
White STRUTTURATO* PGWDIS8
Sun STRUTTURATO* PGWDIS7
Origin STRUTTURATO* PGWDIS5

DESTINAZIONI D'USO_INTENDED USE: NATURALE STRUTTURATO

DATI TECNICI_TECHNICAL DATA:

GRES PORCELLANATO A MASSA COLORATA COLOURED-BODY PORCELAIN STONEWARE		GRES PORCELLANATO A MASSA COLORATA COLOURED-BODY PORCELAIN STONEWARE	
	9 / 9,5 mm		20 mm
DIN EN 16165 - Annex B:	R9 Naturale R11 Strutturato	DIN EN 16165 - Annex B:	R11 Strutturato
DIN EN 16165 - Annex A:	C (A+B+C) Strutturato	DIN EN 16165 - Annex A:	C (A+B+C) Strutturato
BCR TORTUS:	$\mu > 0,40$ Naturale - Strutturato	BCR TORTUS:	$\mu > 0,40$ Strutturato
ANSI A326.3:	ID - DCOF $\geq 0,42$ (dry) Naturale IW - DCOF $\geq 0,42$ (wet) Naturale IW+ Naturale* EW Strutturato	ANSI A326.3:	EW Strutturato
BS 7976-2:	PTV 36+WET (SI.96 - SI.55) Strutturato	BS 7976-2:	PTV 36+WET (SI.96 - SI.55) Strutturato
	ANSI A137.1: V2 Naturale - Strutturato	ANSI A137.1:	V2 Strutturato
PROTECT ANTIBATTERICO - ANTIMICROBIAL	Naturale		

* Ad eccezione delle zone caratterizzate da un maggior rischio di scivolamento (come docce pubbliche, piscine coperte, ecc.) per le quali si consiglia una superficie Strutturato
With the exception of areas characterized by a higher risk of slipping (such as public showers, indoor swimming pools, etc.) for which a Strutturato surface is recommended

* Protezione antibatterica non presente_No antimicrobial protection_Der Antibakterielle Schutz nicht vorhanden_Protection antibactérienne pas présente

Discover

DECORI_DECORS

GRES PORCELLANATO A MASSA COLORATA_COLOURED-BODY PORCELAIN STONEWARE

WHITE

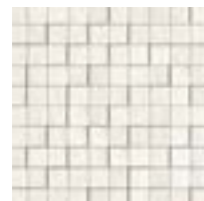

MOSAICO A SBALZO NATURALE
30x30 cm Rect - 12"x12"
± 9,5 mm
PGZDI3M

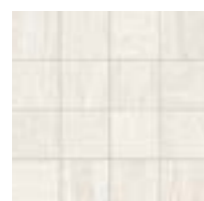

MOSAICO 16 PEZZI NATURALE
30x30 cm Rect - 12"x12"
± 9,5 mm
PGZDI35

SUN

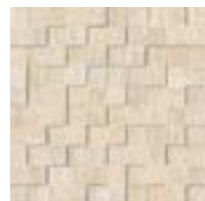

MOSAICO A SBALZO NATURALE
30x30 cm Rect - 12"x12"
± 9,5 mm
PGZDI2M



MOSAICO 16 PEZZI NATURALE
30x30 cm Rect - 12"x12"
± 9,5 mm
PGZDI25

ORIGIN



MOSAICO A SBALZO NATURALE
30x30 cm Rect - 12"x12"
± 9,5 mm
PGZDI0M



MOSAICO 16 PEZZI NATURALE
30x30 cm Rect - 12"x12"
± 9,5 mm
PGZDI05

MOSAICO A SBALZO:

Posare solo a parete_Recommended only for wall applications_Nur an der Wand verlegen_Recommandé seulement pour les revêtements

PEZZI SPECIALI_TRIM PIECES

GRES PORCELLANATO A MASSA COLORATA_COLOURED-BODY PORCELAIN STONEWARE

BATTISCOPA 10x60 cm Rect - 4"x24" ± 10 mm NATURALE	GRADONE TORO VUOTO BORDO 30x34 cm Rect - 12"x13 ^{9/16} " ± 9,5 mm NATURALE	GRADONE TORO VUOTO ANGOLARE DX 34x34 cm - 13 ^{9/16} "x13 ^{9/16} " ± 9,5 mm NATURALE	GRADONE TORO VUOTO ANGOLARE SX 34x34 cm - 13 ^{9/16} "x13 ^{9/16} " ± 9,5 mm NATURALE	GRADINO 30x30 cm Rect - 12"x12" ± 9,5 mm NATURALE
WHITE PGRDIR3	PGEDI30	PGEDI31	PGEDI32	PGDDI30
SUN PGRDIR2	PGEDI20	PGEDI21	PGEDI22	PGDDI20
ORIGIN PGRDI00	PGEDI00	PGEDI01	PGEDI02	PGDDI00

BATTISCOPA SCALA DX (kit 2 pezzi) 10x45 cm - 4"x18" ± 10 mm NATURALE	BATTISCOPA SCALA SX (kit 2 pezzi) 10x45 cm - 4"x18" ± 10 mm NATURALE	RACCORDO* 1x30 cm Rect - 3/8"x12" NATURALE	ANGOLO RACCORDO* 1x1 cm - 3/8"x3/8" NATURALE	ELEMENTO "L" 15x30x4 cm - 4"x12"x1 ^{9/16} " ± 9 mm STRUTTURATO
WHITE PGZDI3D	PGZDI3S	PGZDI30	PGZDI31	PGZDIA3
SUN PGZDI2D	PGZDI2S	PGZDI20	PGZDI21	PGZDIA2
ORIGIN PGZDI0D	PGZDI0S	PGZDI00	PGZDI01	PGZDIA0

RACCORDO - ANGOLO RACCORDO:

Posare solo all'interno_Strictly for interiors_Nur im Innenraum zu verlegen_Poser seulement à l'intérieur

* Protezione antibatterica non presente_No antimicrobial protection_Der Antibakterielle Schutz nicht vorhanden_Protection antibactérienne pas présente

Discover

PEZZI SPECIALI_TRIM PIECES

GRES PORCELLANATO A MASSA COLORATA_COLOURED-BODY PORCELAIN STONEWARE **20 mm**

COSTA TORO ANGOLARE DX 30x60 cm Rect - 12"x24" STRUTTURATO*	COSTA TORO ANGOLARE SX 30x60 cm Rect - 12"x24" STRUTTURATO*	COSTA TORO 30x60 cm Rect - 12"x24" STRUTTURATO*	COSTA TORO GRIP 30x60 cm Rect - 12"x24" STRUTTURATO*	COSTA RETTA ANGOLARE DX 30x60 cm Rect - 12"x24" STRUTTURATO*	COSTA RETTA ANGOLARE SX 30x60 cm Rect - 12"x24" STRUTTURATO*
WHITE PGDDIK6	PGDDIK3	PGDDIF3	PGDDIJ3	PGDDID6	PGDDID3
SUN PGDDIK5	PGDDIK2	PGDDIF2	PGDDIJ2	PGDDID5	PGDDID2
ORIGIN PGDDIK4	PGDDIK0	PGDDIF0	PGDDIJ0	PGDDID4	PGDDID0
COSTA RETTA 30x60 cm Rect - 12"x24" STRUTTURATO*	COSTA RETTA GRIP 30x60 cm Rect - 12"x24" STRUTTURATO*	GRIGLIA ANGOLARE DX 15x60 cm Rect - 6"x24" STRUTTURATO*	GRIGLIA ANGOLARE SX 15x60 cm Rect - 6"x24" STRUTTURATO*	GRIGLIA 15x60 cm Rect - 6"x24" STRUTTURATO*	
WHITE PGDDIC3	PGDDIG3	PGDDIA6	PGDDIA3	PGDDIZ3	
SUN PGDDIC2	PGDDIG2	PGDDIA5	PGDDIA2	PGDDIZ2	
ORIGIN PGDDIC0	PGDDIG0	PGDDIA4	PGDDIA0	PGDDIZ0	

* Protezione antibatterica non presente_No antimicrobial protection_Der Antibakterielle Schutz nicht vorhanden_Protection antibactérienne pas présente

IMBALLAGGI E PESI_PACKINGS AND WEIGHTS

DESCRIZIONE Description	± mm	FORMATI Sizes	SCATOLA_Box				PALLET		
FONDO NATURALE	9,5	60x60 ^{RECT}	4	31,8	1,44	-	32	1018	46,1
FONDO NATURALE	9,5	30x60 ^{RECT}	8	31,8	1,44	-	32	1018	46,1
FONDO STRUTTURATO	9	30x60,3	9	33,45	1,628	-	32	1070,4	52,099
FONDO NATURALE	9,5	20x60 ^{RECT}	13	31,9	1,56	-	30	957	46,8
FONDO NATURALE	9,5	15x60 ^{RECT}	16	29,5	1,44	-	32	944	46,1
FONDO NATURALE	9,5	7,5x60 ^{RECT}	15	14,9	0,68	-	40	596	27,2
FONDO NATURALE	9,5	5x60 ^{RECT}	15	9,4	0,45	-	64	601,6	28,8
MOSAICO 16 PEZZI NATURALE	9,5	30x30 ^{RECT}	4	7,2	0,36	-	78	562	28,1
MOSAICO A SBALZO NATURALE	9,5	30x30 ^{RECT}	4	7,2	0,36	-	78	562	28,1
RACCORDO NATURALE	-	1x30 ^{RECT}	8	0,8	0,024	-	-	-	-
ANGOLO RACCORDO NATURALE	-	1x1	10	0,07	0,001	-	-	-	-
BATTISCOPA NATURALE	10	10x60 ^{RECT}	12	15,48	0,72	7,2	60	928,8	43,2
BATTISCOPA SCALA (KIT 2 PZ.) NATURALE	10	10x45	5	8,5	0,425	-	-	-	-
GRADINO NATURALE	9,5	30x30 ^{RECT}	13	25,9	1,17	-	40	1036	46,8
GRADONE TORO VUOTO BORDO NATURALE	9,5	30x34 ^{RECT}	6	14,8	0,612	-	30	444	18,4
GRADONE TORO VUOTO ANGOLARE NATURALE	9,5	34x34	2	5,4	0,22	-	46	248,4	10,12
ELEMENTO "L" STRUTTURATO	9	15x30x4	8	9,6	0,36	2,4	48	460,8	17,28
FONDO STRUTTURATO	20	60x120 ^{RECT}	1	32,5	0,72	-	36	1170	25,92
FONDO STRUTTURATO	20	60x60 ^{RECT}	2	33	0,72	-	32	1056	23,04
COSTA TORO STRUTTURATO	20	30x60 ^{RECT}	1	8,125	0,135	-	100	812,5	13,5
COSTA TORO ANGOLARE STRUTTURATO	20	30x60 ^{RECT}	1	6,1	0,135	-	100	610	13,5
COSTA TORO GRIP STRUTTURATO	20	30x60 ^{RECT}	1	8,125	0,135	-	100	812,5	13,5
COSTA RETTA STRUTTURATO	20	30x60 ^{RECT}	1	8,125	0,135	-	100	812,5	13,5
COSTA RETTA ANGOLARE STRUTTURATO	20	30x60 ^{RECT}	1	6,1	0,135	-	100	610	13,5
COSTA RETTA GRIP STRUTTURATO	20	30x60 ^{RECT}	1	8,125	0,135	-	100	812,5	13,5
GRIGLIA STRUTTURATO	20	15x60 ^{RECT}	2	8	0,158	-	100	800	15,8
GRIGLIA ANGOLARE STRUTTURATO	20	15x60 ^{RECT}	2	7	0,158	-	100	700	15,8



Frame



GLEN



RIVER



PEAK



GROOVE



GORGE

GRES PORCELLANATO A MASSA COLORATA_COLOURED-BODY PORCELAIN STONWARE



± 9 mm



120x120 cm Rect
48"x48"

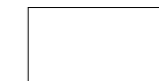

60x120 cm Rect
24"x48"



60x60 cm Rect
24"x24"



30x60 cm Rect
12"x24"

GRES PORCELLANATO A MASSA COLORATA_COLOURED-BODY PORCELAIN STONWARE **20 mm**



± 20 mm



45x90 cm Rect
18"x36"



60x60 cm Rect
24"x24"



RIVESTIMENTO / WALL Groove Naturale 60x120 cm Rect - 24"x48"
PAVIMENTO / FLOOR Glen Naturale 120x120 cm Rect - 48"x48"



RIVESTIMENTO / WALL Muretto Glen Naturale 30x60 cm Rect - 12"x24"
 PAVIMENTO / FLOOR Groove Naturale 60x120 cm Rect - 24"x48"



PAVIMENTO / FLOOR Peak Naturale 60x60 cm Rect - 24"x24"



RIVESTIMENTO / WALL Muretto River Naturale 30x60 cm Rect - 12"x24"
PAVIMENTO / FLOOR River Naturale 60x120 cm Rect - 24"x48"

Frame

GLEN



RIVER



PEAK



GROOVE



GORGE



Frame

GRES PORCELLANATO A MASSA COLORATA_COLOURED-BODY PORCELAIN STONEWARE

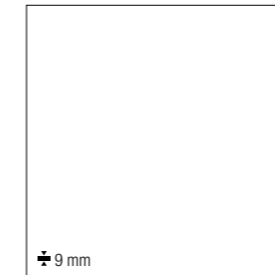

120x120 cm Rect - 48"x48"

Glen NATURALE FG8FMR0
River NATURALE FG8FMR3
Peak NATURALE FG8FMR2
Groove NATURALE FG8FMR1
Gorge NATURALE FG8FMR4



60x120 cm Rect - 24"x48"

Glen NATURALE FGXFMR0
River NATURALE FGXFMR3
Peak NATURALE FGXFMR2
Groove NATURALE FGXFMR1
Gorge NATURALE FGXFMR4



60x60 cm Rect - 24"x24"

Glen NATURALE FGWFMRO
River NATURALE FGWFM3
Peak NATURALE FGWFM2
Groove NATURALE FGWFM1
Gorge NATURALE FGWFM4
Glen STRUTTURATO FGWFM05
River STRUTTURATO FGWFM35
Peak STRUTTURATO FGWFM25
Groove STRUTTURATO FGWFM15
Gorge STRUTTURATO FGWFM45

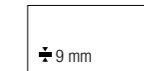

30x60 cm Rect - 12"x24"

Glen NATURALE FG-FMR0G
River NATURALE FG-FMR3G
Peak NATURALE FG-FMR2G
Groove NATURALE FG-FMR1G
Gorge NATURALE FG-FMR4G
Glen STRUTTURATO FG-FM05G
River STRUTTURATO FG-FM35G
Peak STRUTTURATO FG-FM25G
Groove STRUTTURATO FG-FM15G
Gorge STRUTTURATO FG-FM45G

GRES PORCELLANATO A MASSA COLORATA_COLOURED-BODY PORCELAIN STONEWARE 20 mm

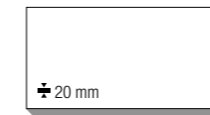

45x90 cm Rect - 18"x36"

Glen STRUTTURATO FGHF60
River STRUTTURATO FGHF63
Peak STRUTTURATO FGHF62
Groove STRUTTURATO FGHF61
Gorge STRUTTURATO FGHF64



60x60 cm Rect - 24"x24"

Glen STRUTTURATO FGWFM60
River STRUTTURATO FGWFM63
Peak STRUTTURATO FGWFM62
Groove STRUTTURATO FGWFM61
Gorge STRUTTURATO FGWFM64

DESTINAZIONI D'USO_INTENDED USE: NATURALE STRUTTURATO

DATI TECNICI_TECHNICAL DATA:

GRES PORCELLANATO A MASSA COLORATA COLOURED-BODY PORCELAIN STONEWARE		GRES PORCELLANATO A MASSA COLORATA COLOURED-BODY PORCELAIN STONEWARE	
9 mm		20 mm	
DIN EN 16165 - Annex B:	R10 Naturale R11 Strutturato	DIN EN 16165 - Annex B:	R11 Strutturato
DIN EN 16165 - Annex A:	B (A+B) Naturale C (A+B+C) Strutturato	DIN EN 16165 - Annex A:	C (A+B+C) Strutturato
BCR TORTUS:	$\mu > 0,40$ Naturale - Strutturato	BCR TORTUS:	$\mu > 0,40$ Strutturato
ANSI A326.3:	ID - DCOF $\geq 0,42$ (dry) Naturale IW - DCOF $\geq 0,42$ (wet) Naturale IW+ Naturale*	ANSI A326.3:	EW Strutturato
AS/NZS 4586:	EW Strutturato P3 Naturale	AS/NZS 4586:	P4 Strutturato
BS 7976-2:	P4 Strutturato PTV 36+WET (SI.96) Naturale PTV 36+WET (SI.96 - SI.55) Strutturato	BS 7976-2:	PTV 36+WET (SI.96 - SI.55) Strutturato
ANSI A137.1:	V2 Naturale - Strutturato (Glen-River-Peak-Groove) V3 Naturale - Strutturato (Gorge)	ANSI A137.1:	V2 Strutturato (Glen-River-Peak-Groove) V3 Strutturato (Gorge)

* Ad eccezione delle zone caratterizzate da un maggior rischio di scivolamento (come docce pubbliche, piscine coperte, ecc.) per le quali si consiglia una superficie Strutturato
* With the exception of areas characterized by a higher risk of slipping (such as public showers, indoor swimming pools, etc.) for which a Strutturato surface is recommended

Frame

DECORI_DECORS

GRES PORCELLANATO A MASSA COLORATA_COLOURED-BODY PORCELAIN STONWARE

GLEN



MURETTO NATURALE
30x60 cm Rect - 12"x24"
± 9 mm
FG-FMM0

GROOVE



MURETTO NATURALE
30x60 cm Rect - 12"x24"
± 9 mm
FG-FMM1

RIVER



MURETTO NATURALE
30x60 cm Rect - 12"x24"
± 9 mm
FG-FMM3

GORGE



MURETTO NATURALE
30x60 cm Rect - 12"x24"
± 9 mm
FG-FMM4

PEAK



MURETTO NATURALE
30x60 cm Rect - 12"x24"
± 9 mm
FG-FMM2



MOSAICO 36 PEZZI NATURALE
30x30 cm Rect - 12"x12"
± 9 mm
PGZFM00

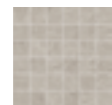

MOSAICO 36 PEZZI NATURALE
30x30 cm Rect - 12"x12"
± 9 mm
PGZFM30

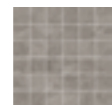

MOSAICO 36 PEZZI NATURALE
30x30 cm Rect - 12"x12"
± 9 mm
PGZFM20



MOSAICO 36 PEZZI NATURALE
30x30 cm Rect - 12"x12"
± 9 mm
PGZFM10

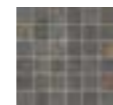

MOSAICO 36 PEZZI NATURALE
30x30 cm Rect - 12"x12"
± 9 mm
PGZFM40

Frame

PEZZI SPECIALI_TRIM PIECES

GRES PORCELLANATO A MASSA COLORATA_COLOURED-BODY PORCELAIN STONWARE



BATTISCOPIA
10x60 cm Rect - 4"x24"
± 9 mm
NATURALE

GLEN	FGFRMR0A
RIVER	FGFRMR3A
PEAK	FGFRMR2A
GROOVE	FGFRMR1A
GORGE	FGFRMR4A

PEZZI SPECIALI_TRIM PIECES

GRES PORCELLANATO A MASSA COLORATA_COLOURED-BODY PORCELAIN STONWARE **20 mm**



COSTA TORO ANGOLARE DX
30x90 cm Rect - 12"x36"
STRUTTURATO*



COSTA TORO ANGOLARE SX
30x90 cm Rect - 12"x36"
STRUTTURATO*



COSTA TORO
30x90 cm Rect - 12"x36"
STRUTTURATO*



COSTA TORO GRIP
30x90 cm Rect - 12"x36"
STRUTTURATO*



COSTA RETTA ANGOLARE DX
30x90 cm Rect - 12"x36"
STRUTTURATO*

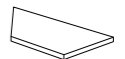

COSTA RETTA ANGOLARE SX
30x90 cm Rect - 12"x36"
STRUTTURATO*

GLEN	FGFFMK0	FGFFMK5	FGFFMF0	FGFFMJ0	FGFFMD0	FGFFMD5
RIVER	FGFFMK3	FGFFMK8	FGFFMF3	FGFFMJ3	FGFFMD3	FGFFMD8
PEAK	FGFFMK2	FGFFMK7	FGFFMF2	FGFFMJ2	FGFFMD2	FGFFMD7
GROOVE	FGFFMK1	FGFFMK6	FGFFMF1	FGFFMJ1	FGFFMD1	FGFFMD6
GORGE	FGFFMK4	FGFFMK9	FGFFMF4	FGFFMJ4	FGFFMD4	FGFFMD9

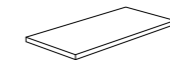

COSTA RETTA
30x90 cm Rect - 12"x36"
STRUTTURATO*



COSTA RETTA GRIP
30x90 cm Rect - 12"x36"
STRUTTURATO*

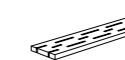

GRIGLIA ANGOLARE DX
15x45 cm Rect - 6"x18"
STRUTTURATO*



GRIGLIA ANGOLARE SX
15x45 cm Rect - 6"x18"
STRUTTURATO*

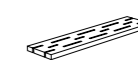

GRIGLIA
15x45 cm Rect - 6"x18"
STRUTTURATO*

GLEN	FGDFMC0	FGDFMG0	FGDFMA0	FGDFMA5	FGDFM20
RIVER	FGDFMC3	FGDFMG3	FGDFMA3	FGDFMA8	FGDFM23
PEAK	FGDFMC2	FGDFMG2	FGDFMA2	FGDFMA7	FGDFM22
GROOVE	FGDFMC1	FGDFMG1	FGDFMA1	FGDFMA6	FGDFM21
GORGE	FGDFMC4	FGDFMG4	FGDFMA4	FGDFMA9	FGDFM24



COSTA TORO ANGOLARE DX
30x60 cm Rect - 12"x24"
STRUTTURATO*



COSTA TORO ANGOLARE SX
30x60 cm Rect - 12"x24"
STRUTTURATO*

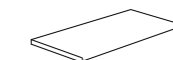

COSTA TORO
30x60 cm Rect - 12"x24"
STRUTTURATO*



COSTA TORO GRIP
30x60 cm Rect - 12"x24"
STRUTTURATO*



COSTA RETTA ANGOLARE DX
30x60 cm Rect - 12"x24"
STRUTTURATO*

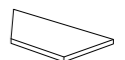

COSTA RETTA ANGOLARE SX
30x60 cm Rect - 12"x24"
STRUTTURATO*

GLEN	FGDFMK0	FGDFMK5	FGDFMF0	FGDFMJ0	FGDFMD0	FGDFMD5
RIVER	FGDFMK3	FGDFMK4	FGDFMF3	FGDFMJ3	FGDFMD3	FGDFMD8
PEAK	FGDFMK2	FGDFMK7	FGDFMF2	FGDFMJ2	FGDFMD2	FGDFMD7
GROOVE	FGDFMK1	FGDFMK6	FGDFMF1	FGDFMJ1	FGDFMD1	FGDFMD6
GORGE	FGDFMK8	FGDFMK9	FGDFMF4	FGDFMJ4	FGDFMD4	FGDFMD9



COSTA RETTA
30x60 cm Rect - 12"x24"
STRUTTURATO*



COSTA RETTA GRIP
30x60 cm Rect - 12"x24"
STRUTTURATO*

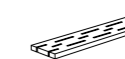

GRIGLIA ANGOLARE DX
15x60 cm Rect - 6"x24"
STRUTTURATO*



GRIGLIA ANGOLARE SX
15x60 cm Rect - 6"x24"
STRUTTURATO*

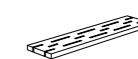

GRIGLIA
15x60 cm Rect - 6"x24"
STRUTTURATO*

GLEN	FG1FMC0	FG1FMG0	FG1FMA0	FG1FMA5	FG1FM20
RIVER	FG1FMC3	FG1FMG3	FG1FMA3	FG1FMA8	FG1FM23
PEAK	FG1FMC2	FG1FMG2	FG1FMA2	FG1FMA7	FG1FM22
GROOVE	FG1FMC1	FG1FMG1	FG1FMA1	FG1FMA6	FG1FM21
GORGE	FG1FMC5	FG1FMG4	FG1FMA4	FG1FMA9	FG1FM24

* Protezione antibatterica non presente_No antimicrobial protection_Der Antibakterielle Schutz nicht vorhanden_Protection antibactérienne pas présente

Frame

IMBALLAGGI E PESI / PACKINGS AND WEIGHTS

DESCRIZIONE Description	mm	FORMATI Sizes	SCATOLA_Box				PALLET		
			Icon	KG	M ²	ML	Icon	KG	M ²
FONDO NATURALE	9	120x120 ^{RECT}	1	31,8	1,44	-	28	890,4	40,32
FONDO NATURALE	9	60x120 ^{RECT}	2	31,8	1,44	-	36	1144,8	51,84
FONDO NATURALE / STRUTTURATO	9	60x60 ^{RECT}	4	30,5	1,44	-	32	976	46,08
FONDO NATURALE / STRUTTURATO	9	30x60 ^{RECT}	9	35	1,62	-	32	1120	51,84
MURETTO NATURALE	9	30x60 ^{RECT}	4	15,7	0,72	-	30	471	21,6
MOSAICO 36 PEZZI NATURALE	9	30x30 ^{RECT}	5	10,07	0,45	-	60	604,2	27
BATTISCOPA NATURALE	9	10x60 ^{RECT}	12	15,48	0,72	7,2	60	928,8	43,2
FONDO STRUTTURATO	20	45x90 ^{RECT}	2	36,23	0,81	-	24	869,52	19,44
FONDO STRUTTURATO	20	60x60 ^{RECT}	2	32,5	0,72	-	32	1040	23,04
COSTA TORO STRUTTURATO	20	30x90 ^{RECT}	1	12,2	0,27	-	32	390	8,64
COSTA TORO ANGOLARE STRUTTURATO	20	30x90 ^{RECT}	1	10,2	0,23	-	32	326	7,2
COSTA TORO GRIP STRUTTURATO	20	30x90 ^{RECT}	1	12,2	0,27	-	32	390	8,64
COSTA RETTA STRUTTURATO	20	30x90 ^{RECT}	1	12,2	0,27	-	32	390	8,64
COSTA RETTA ANGOLARE STRUTTURATO	20	30x90 ^{RECT}	1	10,2	0,23	-	32	326	7,2
COSTA RETTA GRIP STRUTTURATO	20	30x90 ^{RECT}	1	12,2	0,27	-	32	390	8,64
GRIGLIA STRUTTURATO	20	15x45 ^{RECT}	4	11,2	0,27	-	48	538	12,96
GRIGLIA ANGOLARE STRUTTURATO	20	15x45 ^{RECT}	4	10	0,23	-	48	480	10,8
COSTA TORO STRUTTURATO	20	30x60 ^{RECT}	1	8,125	0,135	-	100	812,5	13,5
COSTA TORO ANGOLARE STRUTTURATO	20	30x60 ^{RECT}	1	6,1	0,135	-	100	610	13,5
COSTA TORO GRIP STRUTTURATO	20	30x60 ^{RECT}	1	8,125	0,135	-	100	812,5	13,5
COSTA RETTA STRUTTURATO	20	30x60 ^{RECT}	1	8,125	0,135	-	100	812,5	13,5
COSTA RETTA ANGOLARE STRUTTURATO	20	30x60 ^{RECT}	1	6,1	0,135	-	100	610	13,5
COSTA RETTA GRIP STRUTTURATO	20	30x60 ^{RECT}	1	8,125	0,135	-	100	812,5	13,5
GRIGLIA STRUTTURATO	20	15x60 ^{RECT}	2	8	0,158	-	100	800	15,8
GRIGLIA ANGOLARE STRUTTURATO	20	15x60 ^{RECT}	2	7	0,158	-	100	700	15,8



PAVIMENTO / FLOOR Groove Strutturato 45x90 cm Rect - 18"x36" 20 mm



Pierre des Rêves



REVELLE



NUAGE



AURORE



CHARME



OUBLI

GRES PORCELLANATO A MASSA COLORATA_COLOURED-BODY PORCELAIN STONEWARE



± 9,5 mm
± 12 mm



90x90 cm Rect
36"x36"



60x120 cm Rect
24"x48"



60x60 cm Rect
24"x24"



30x60 cm Rect
12"x24"



20x40,4 cm
8"x16"



20x30,2 cm
8"x12"



20x20 cm
8"x8"

GRES PORCELLANATO A MASSA COLORATA_COLOURED-BODY PORCELAIN STONEWARE **20 mm**



± 20 mm



60x120 cm Rect
24"x48"

RIVESTIMENTO / WALL Muretto Aurore Naturale 30x60 cm Rect - 12"x24"
PAVIMENTO / FLOOR Aurore Naturale 90x90 cm Rect - 36"x36"



RIVESTIMENTO / WALL Muretto Charme Naturele 30x60 cm Rect - 12"x24"
PAVIMENTO / FLOOR Charme Naturele 90x90 cm Rect - 36"x36"_Charme Strutturato 60x120 cm Rect - 24"x48" 20 mm



PAVIMENTO / FLOOR Chevron Nuage Naturele 29,2x39 cm Rect - 11¹/₂"x15³/₈"



RIVESTIMENTO / WALL Muretto Oubli Naturele 30x60 cm Rect - 12"x24"
PAVIMENTO / FLOOR Oubli Naturele 60x120 cm Rect - 24"x48"_Oubli Ext 60x60 cm Rect - 24"x24"



RIVESTIMENTO / WALL Reveille Naturelle 60x120 cm Rect - 24"x48" _Mosaico 16 pezzi Oubli Naturelle 30x30 cm Rect - 12"x12"
PAVIMENTO / FLOOR Reveille Naturelle 60x60 cm Rect - 24"x24"



PAVIMENTO / FLOOR Aurore Structurato 20x20 cm - 8"x8" _20x30,2 cm - 8"x12" _20x40,4 cm - 8"x16"



PAVIMENTO / FLOOR Nuage Structurato 20x20 cm - 8"x8" _20x30,2 cm - 8"x12" _20x40,4 cm - 8"x16"

Pierre des Rêves

PROTECT
ANTIBATTERICO - ANTIMICROBIAL

REVEILLE



NUAGE



AURORE



CHARME



OUBLI



Pierre des Rêves

GRES PORCELLANATO A MASSA COLORATA_COLOURED-BODY PORCELAIN STONEWARE



90x90 cm Rect - 36"x36"
Reveille NATURALE PGGP840G
Nuage NATURALE PGGP810G
Aurore NATURALE PGGP800G
Charme NATURALE PGGP830G
Oubli NATURALE PGGP820G

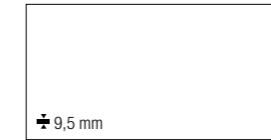

60x120 cm Rect - 24"x48"
Reveille NATURALE PGXP890
Nuage NATURALE PGXP860
Aurore NATURALE PGXP850
Charme NATURALE PGXP880
Oubli NATURALE PGXP870



60x60 cm Rect - 24"x24"
Reveille NATURALE PGWP890
Nuage NATURALE PGWP860
Aurore NATURALE PGWP850
Charme NATURALE PGWP880
Oubli NATURALE PGWP870
Reveille EXT* PGWP840
Nuage EXT* PGWP810
Aurore EXT* PGWP800
Charme EXT* PGWP830
Oubli EXT* PGWP820

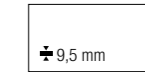

30x60 cm Rect - 12"x24"
Reveille NATURALE PG-P890
Nuage NATURALE PG-P860
Aurore NATURALE PG-P850
Charme NATURALE PG-P880
Oubli NATURALE PG-P870
Reveille EXT* PG-P840
Nuage EXT* PG-P810
Aurore EXT* PG-P800
Charme EXT* PG-P830
Oubli EXT* PG-P820



20x40,4 cm - 8"x16"
Nuage STRUTTURATO* PGKP810
Aurore STRUTTURATO* PGKP800
Oubli STRUTTURATO* PGKP820



20x30,2 cm - 8"x12"
Nuage STRUTTURATO* PGBP810
Aurore STRUTTURATO* PGBP800
Oubli STRUTTURATO* PGBP820



20x20 cm - 8"x8"
Nuage STRUTTURATO* PGEP810
Aurore STRUTTURATO* PGEP800
Oubli STRUTTURATO* PGEP820

GRES PORCELLANATO A MASSA COLORATA_COLOURED-BODY PORCELAIN STONEWARE 20 mm

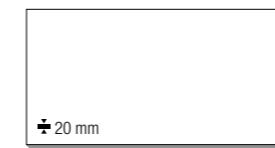

60x120 cm Rect - 24"x48"
Reveille STRUTTURATO* PGXP8401
Nuage STRUTTURATO* PGXP8101
Aurore STRUTTURATO* PGXP8001
Charme STRUTTURATO* PGXP8301
Oubli STRUTTURATO* PGXP8201

DESTINAZIONI D'USO_INTENDED USE: NATURALE STRUTTURATO / EXT

DATI TECNICI_TECHNICAL DATA:

GRES PORCELLANATO A MASSA COLORATA COLOURED-BODY PORCELAIN STONEWARE		GRES PORCELLANATO A MASSA COLORATA COLOURED-BODY PORCELAIN STONEWARE	
±	9,5 / 12 mm		20 mm
DIN EN 16165 - Annex B:	R10 Naturale R11 Ext R12 Strutturato	DIN EN 16165 - Annex B:	R12 Strutturato
DIN EN 16165 - Annex A:	A Naturale C (A+B+C) Ext - Strutturato	DIN EN 16165 - Annex A:	C (A+B+C) Strutturato
BCR TORTUS: ANSI A326.3:	μ > 0,40 Naturale - Ext - Strutturato ID - DCOF ≥ 0.42 (dry) Naturale IW+ Naturale* EW+ Naturale*	BCR TORTUS: ANSI A326.3: AS/NZS 4586: BS 7976-2:	μ > 0,40 Strutturato EW Strutturato P4 Strutturato PTV 36+WET (SI.96 - SI.55) Strutturato
AS/NZS 4586: BS 7976-2:	P4 Ext - Strutturato PTV 36+WET (SI.96 - SI.55) Ext - Strutturato		
	ANSI A137.1: V4 Naturale - Ext - Strutturato		ANSI A137.1: V4 Strutturato
PROTECT ANTIBATTERICO - ANTIMICROBIAL	Naturale		

* Ad eccezione delle zone caratterizzate da un maggior rischio di scivolamento (come docce pubbliche, piscine coperte, ecc.) per le quali si consiglia una superficie Ext - Strutturato
With the exception of areas characterized by a higher risk of slipping (such as public showers, indoor swimming pools, etc.) for which a Ext - Strutturato surface is recommended

SOLUZIONI DI POSA OUTDOOR_OUTDOOR LAYING SOLUTIONS 12 mm

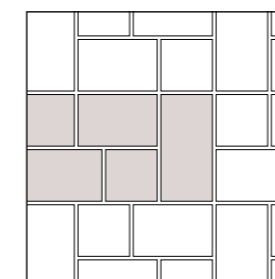

20x40,4 (28,69%) - 20x30,2 (42,90%) - 20x20 (28,41%)

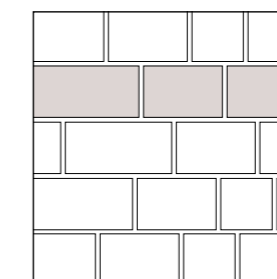

20x40,4 (44,59%) - 20x30,2 (33,33%) - 20x20 (22,08%)

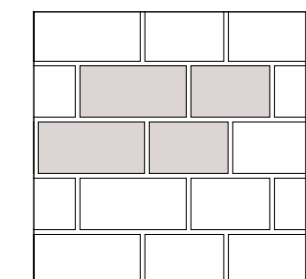

20x30,2 (42,78%) - 20x40,4 (57,22%)

Fuga consigliata: vedi pag. 419_Suggested joint: see pag. 419_Empfohlene Fuge: siehe Seite 419_Joint conseillé : voir page 419

* Protezione antibatterica non presente_No antimicrobial protection_Der Antibakterielle Schutz nicht vorhanden_Protection antibactérienne pas présente

Pierre des Rêves

DECORI_DECORS

GRES PORCELLANATO A MASSA COLORATA_COLOURED-BODY PORCELAIN STONEWARE

REVEILLE	NUAGE	AURORE	CHARME	OUBLI
MURETTO NATURALE 30x60 cm Rect - 12"x24" ± 9,5 mm PGZP8M4	MURETTO NATURALE 30x60 cm Rect - 12"x24" ± 9,5 mm PGZP8M1	MURETTO NATURALE 30x60 cm Rect - 12"x24" ± 9,5 mm PGZP8M0	MURETTO NATURALE 30x60 cm Rect - 12"x24" ± 9,5 mm PGZP8M3	MURETTO NATURALE 30x60 cm Rect - 12"x24" ± 9,5 mm PGZP8M2
CHEVRON NATURALE 29,2x39 cm Rect - 11 1/2"x15 3/8" ± 9,5 mm PGZP8C4	CHEVRON NATURALE 29,2x39 cm Rect - 11 1/2"x15 3/8" ± 9,5 mm PGZP8C1	CHEVRON NATURALE 29,2x39 cm Rect - 11 1/2"x15 3/8" ± 9,5 mm PGZP8C0	CHEVRON NATURALE 29,2x39 cm Rect - 11 1/2"x15 3/8" ± 9,5 mm PGZP8C3	CHEVRON NATURALE 29,2x39 cm Rect - 11 1/2"x15 3/8" ± 9,5 mm PGZP8C2
MOSAICO 16 PEZZI NATURALE 30x30 cm Rect - 12"x12" ± 9,5 mm PGZP890	MOSAICO 16 PEZZI NATURALE 30x30 cm Rect - 12"x12" ± 9,5 mm PGZP860	MOSAICO 16 PEZZI NATURALE 30x30 cm Rect - 12"x12" ± 9,5 mm PGZP850	MOSAICO 16 PEZZI NATURALE 30x30 cm Rect - 12"x12" ± 9,5 mm PGZP880	MOSAICO 16 PEZZI NATURALE 30x30 cm Rect - 12"x12" ± 9,5 mm PGZP870
TABLEAU 60x120 cm Rect - 24"x48" ± 9,5 mm PGXP8T1	TABLEAU 60x120 cm Rect - 24"x48" ± 9,5 mm PGXP8T0	TABLEAU 60x120 cm Rect - 24"x48" ± 9,5 mm PGXP8T3	TABLEAU 60x120 cm Rect - 24"x48" ± 9,5 mm PGXP8T2	

TABLEAU:
Decoro sviluppato su 2 soggetti diversi venduti insieme_Decoration developed on 2 different patterns sold together_Dekor zu 2 verschiedenen Themen entwickelt, die zusammen verkauft werden_Décor développé sur 2 sujets différents vendus ensemble

PEZZI SPECIALI_TRIM PIECES

GRES PORCELLANATO A MASSA COLORATA_COLOURED-BODY PORCELAIN STONEWARE

	BATTISCOPA	GRADONE A COSTA RETTA	ANGOLO GRADONE A COSTA RETTA
	BATTISCOPA 7,5x60 cm Rect - 3"x24" ± 10 mm NATURALE	GRADONE A COSTA RETTA 30x34 cm Rect - 12"x13 3/8" ± 9,5 mm NATURALE	ANGOLO GRADONE A COSTA RETTA 34x34 cm - 13 3/8"x13 3/8" ± 9,5 mm NATURALE
REVEILLE	PGRP840	PGEP840	PGEP841
NUAGE	PGRP810	PGEP810	PGEP811
AURORE	PGRP800	PGEP800	PGEP801
CHARME	PGRP830	PGEP830	PGEP831
OUBLI	PGRP820	PGEP820	PGEP821

Pierre des Rêves

PEZZI SPECIALI_TRIM PIECES

GRES PORCELLANATO A MASSA COLORATA_COLOURED-BODY PORCELAIN STONEWARE

	BATTISCOPA SCALA DX	BATTISCOPA SCALA SX	ELEMENTO "L" MONOBLOCCO	ELEMENTO "L"
	BATTISCOPA SCALA DX (kit 2 pezzi) 7,5x45 cm - 3"x18" ± 10 mm NATURALE	BATTISCOPA SCALA SX (kit 2 pezzi) 7,5x45 cm - 3"x18" ± 10 mm NATURALE	ELEMENTO "L" MONOBLOCCO 15x30x4 cm - 6"x12"x1 9/16" ± 12 mm STRUTTURATO*	ELEMENTO "L" 15x30x4 cm Rect - 6"x12"x1 9/16" ± 9,5 mm EXT*
REVEILLE	PGZP84D	PGZP84S	/	PGZP8L4
NUAGE	PGZP81D	PGZP81S	PGZP810	PGZP8L1
AURORE	PGZP80D	PGZP80S	PGZP800	PGZP8L0
CHARME	PGZP83D	PGZP83S	/	PGZP8L3
OUBLI	PGZP82D	PGZP82S	PGZP820	PGZP8L2

ELEMENTO "L" MONOBLOCCO:
Abbinabile alla finitura Strutturato_To be used with Strutturato version_Kombinierbar mit Finish Strutturato_Combinable à la finition Strutturato

ELEMENTO "L":
Realizzato tramite incollaggio_Made by gluing_Hergestellt durch Kleben_Réalisé par collage
Abbinabile alla finitura Ext_To be used with Ext version_Kombinierbar mit Finish Ext_Combinable à la finition Ext

GRES PORCELLANATO A MASSA COLORATA_COLOURED-BODY PORCELAIN STONEWARE **20 mm**

	COSTA TORO ANGOLARE DX	COSTA TORO ANGOLARE SX	COSTA TORO	COSTA TORO GRIP	COSTA RETTA ANGOLARE DX	COSTA RETTA ANGOLARE SX
	COSTA TORO ANGOLARE DX 30x60 cm Rect - 12"x24" STRUTTURATO*	COSTA TORO ANGOLARE SX 30x60 cm Rect - 12"x24" STRUTTURATO*	COSTA TORO 30x60 cm Rect - 12"x24" STRUTTURATO*	COSTA TORO GRIP 30x60 cm Rect - 12"x24" STRUTTURATO*	COSTA RETTA ANGOLARE DX 30x60 cm Rect - 12"x24" STRUTTURATO*	COSTA RETTA ANGOLARE SX 30x60 cm Rect - 12"x24" STRUTTURATO*
REVEILLE	PGDP8K8	PGDP8K9	PGDP8F4	PGDP8J4	PGDP8D8	PGDP8D9
NUAGE	PGDP8K2	PGDP8K3	PGDP8F1	PGDP8J1	PGDP8D2	PGDP8D3
AURORE	PGDP8K0	PGDP8K1	PGDP8F0	PGDP8J0	PGDP8D0	PGDP8D1
CHARME	PGDP8K6	PGDP8K7	PGDP8F3	PGDP8J3	PGDP8D6	PGDP8D7
OUBLI	PGDP8K4	PGDP8K5	PGDP8F2	PGDP8J2	PGDP8D4	PGDP8D5
	COSTA RETTA 30x60 cm Rect - 12"x24" STRUTTURATO*	COSTA RETTA GRIP 30x60 cm Rect - 12"x24" STRUTTURATO*	GRIGLIA ANGOLARE DX 15x60 cm Rect - 6"x24" STRUTTURATO*	GRIGLIA ANGOLARE SX 15x60 cm Rect - 6"x24" STRUTTURATO*	GRIGLIA 15x60 cm Rect - 6"x24" STRUTTURATO*	
REVEILLE	PGDP8C4	PGDP8G4	PG1P8A8	PG1P8A9	PGDP8Z4	
NUAGE	PGDP8C1	PGDP8G1	PG1P8A2	PG1P8A3	PGDP8Z1	
AURORE	PGDP8C0	PGDP8G0	PG1P8A0	PG1P8A1	PGDP8Z0	
CHARME	PGDP8C3	PGDP8G3	PG1P8A6	PG1P8A7	PGDP8Z3	
OUBLI	PGDP8C2	PGDP8G2	PG1P8A4	PG1P8A5	PGDP8Z2	

* Protezione antibatterica non presente_No antimicrobial protection_Der Antibakterielle Schutz nicht vorhanden_Protection antibactérienne pas présente

IMBALLAGGI E PESI_PACKINGS AND WEIGHTS

DESCRIZIONE Description	± mm	FORMATI Sizes	SCATOLA_Box				PALLET			
			📦	KG	M ²	ML	📦	KG	M ²	
FONDO NATURALE	9,5	60x120 ^{RECT}	2	31,8	1,44	-	36	1144,8	51,84	
FONDO NATURALE	9,5	90x90 ^{RECT}	2	33,6	1,62	-	25	840	40,5	
FONDO NATURALE / EXT	9,5	60x60 ^{RECT}	4	31,8	1,44	-	32	1017,6	46,08	
FONDO NATURALE / EXT	9,5	30x60 ^{RECT}	8	31,8	1,44	-	32	1017,6	46,08	
FONDO STRUTTURATO	12	20x40,4	10	21	0,808	-	54	1134	43,632	
FONDO STRUTTURATO	12	20x30,2	15	23,1	0,906	-	48	1108,8	43,488	
FONDO STRUTTURATO	12	20x20	22	22,2	0,88	-	45	999	39,6	
TABLEAU	9,5	60x120 ^{RECT}	2	31,8	1,44	-	15	477	21,6	
CHEVRON NATURALE	9,5	29,2x39 ^{RECT}	7	16,34	0,797	-	32	522,88	25,509	
MURETTO NATURALE	9,5	30x60 ^{RECT}	4	15	0,72	-	30	450	21,6	
MOSAICO 16 PEZZI NATURALE	9,5	30x30 ^{RECT}	4	7,5	0,36	-	78	585	28,08	
BATTISCOPA NATURALE	10	7,5x60 ^{RECT}	12	11,61	0,54	7,2	60	696,6	32,4	
BATTISCOPA SCALA (KIT 2 PZ.) NATURALE	10	7,5x45	5	7,5	0,337	-	-	-	-	
GRADONE A COSTA RETTA NATURALE	9,5	30x34 ^{RECT}	6	19,95	0,612	-	30	598,5	18,36	
ANGOLO GRADONE A COSTA RETTA NATURALE	9,5	34x34	2	6,27	0,231	-	48	300,96	11,097	
ELEMENTO "L" EXT	9,5	15x30x4 ^{RECT}	8	8,7	0,36	2,4	48	419,52	17,28	
ELEMENTO "L" MONOBLOCCO STRUTTURATO	12	15x30x4	8	12	0,36	2,4	44	528	15,84	
FONDO STRUTTURATO	20	60x120 ^{RECT}	1	32,5	0,72	-	36	1170	25,92	
COSTA TORO STRUTTURATO	20	30x60 ^{RECT}	1	8,125	0,18	-	100	812,5	18	
COSTA TORO ANGOLARE STRUTTURATO	20	30x60 ^{RECT}	1	6,1	0,135	-	100	610	13,5	
COSTA TORO GRIP STRUTTURATO	20	30x60 ^{RECT}	1	8,125	0,18	-	100	812,5	18	
COSTA RETTA STRUTTURATO	20	30x60 ^{RECT}	1	8,125	0,18	-	100	812,5	18	
COSTA RETTA ANGOLARE STRUTTURATO	20	30x60 ^{RECT}	1	6,1	0,135	-	100	610	13,5	
COSTA RETTA GRIP STRUTTURATO	20	30x60 ^{RECT}	1	8,125	0,18	-	100	812,5	18	
GRIGLIA STRUTTURATO	20	15x60 ^{RECT}	2	8	0,18	-	100	800	18	
GRIGLIA ANGOLARE STRUTTURATO	20	15x60 ^{RECT}	2	7	0,157	-	100	700	15,75	



Pietre di Fanes



ROSSO MISTO

GRES PORCELLANATO TUTTA MASSA_FULL-BODY PORCELAIN STONEWARE



± 9 mm

20x41 cm
8"x16^{1/8}"

20x30,5 cm
8"x12"

20x20 cm
8"x8"

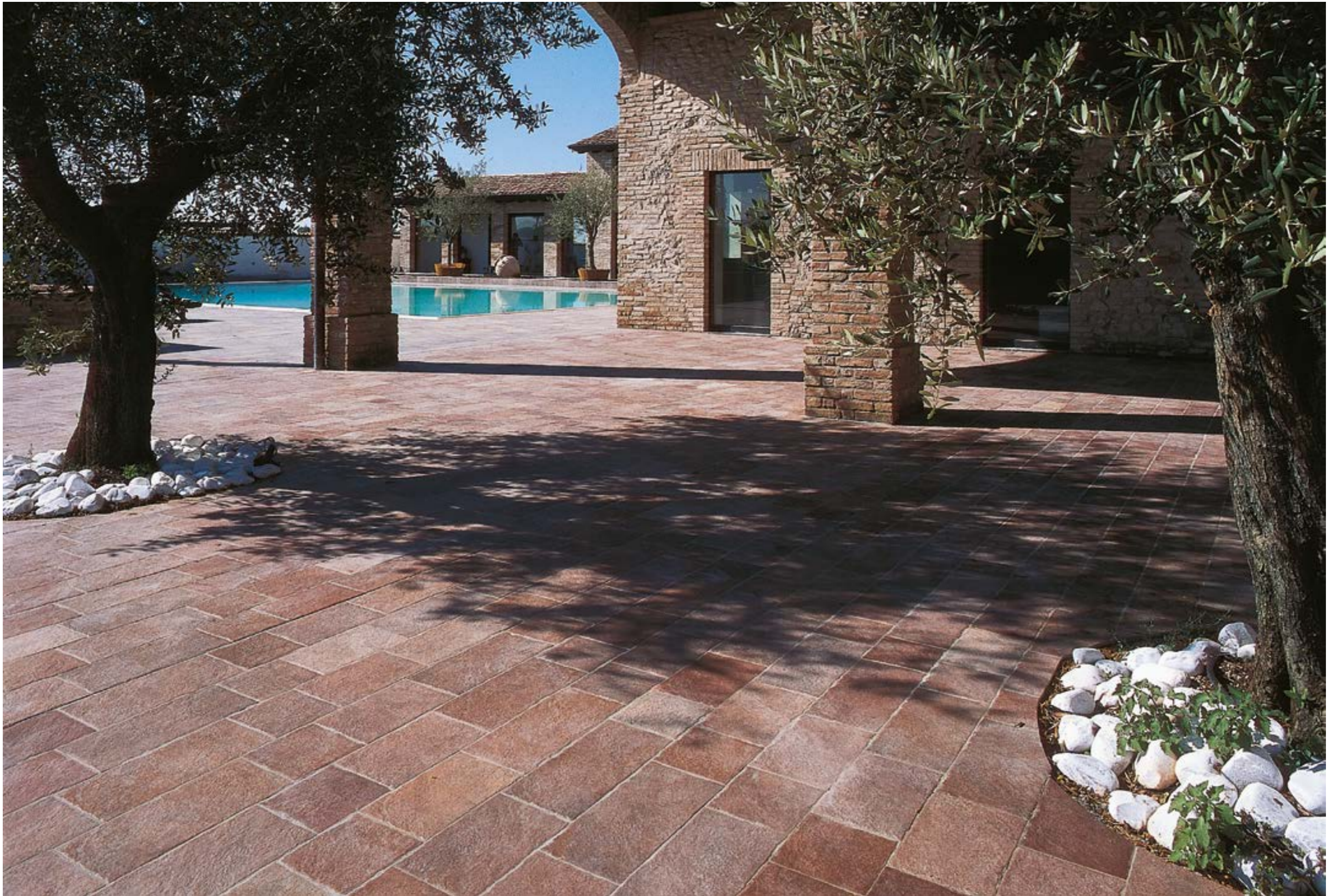

PAVIMENTO / FLOOR Rosso Misto Strutturato 20x20 cm - 8"x8" _20x30,5 cm - 8"x12" _20x41 cm - 8"x16^{1/8}"

Pietre di Fanes

ROSSO MISTO



GRES PORCELLANATO TUTTA MASSA_FULL-BODY PORCELAIN STONEWARE



20x41 cm - 8"x16^{1/8}"

Rosso Misto STRUTTURATO PGKP7151

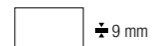

20x30,5 cm - 8"x12"

Rosso Misto STRUTTURATO PGBP715

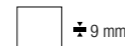

20x20 cm - 8"x8"

Rosso Misto STRUTTURATO PGP715

SOLUZIONI DI POSA_LAYING SOLUTIONS

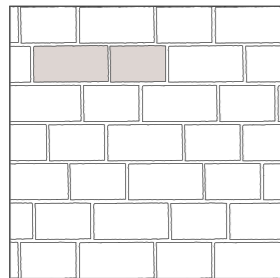

20x30,5 (42,66%) - 20x41 (57,34%)

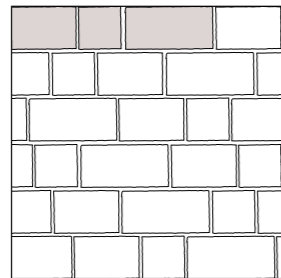

20x20 (21,86%) - 20x30,5 (33,33%)
20x41 (44,81%)

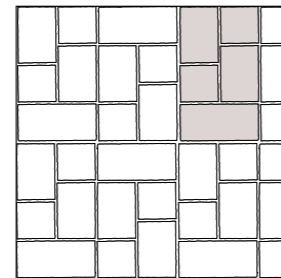

20x20 (28,17%) - 20x30,5 (42,96%)
20x41 (28,87%)

Fuga consigliata: vedi pag. 419_Suggested joint: see pag. 419_Empfohlene Fuge: siehe Seite 419_Joint conseillé : voir page 419

DESTINAZIONI D'USO_INTENDED USE: STRUTTURATO

DATI TECNICI_TECHNICAL DATA:

GRES PORCELLANATO TUTTA MASSA FULL-BODY PORCELAIN STONEWARE	
9 mm	
DIN EN 16165 - Annex B: DIN EN 16165 - Annex A: BCR TORTUS: ANSI A326.3:	R11 Strutturato C (A+B+C) Strutturato $\mu > 0,50$ Strutturato EW Strutturato
EN 101: CTI 81-7 ANNEX A:	MOHS 9 MOHS 9
ANSI A137.1:	V4 Strutturato

Pietre di Fanes

PEZZI SPECIALI_TRIM PIECES

GRES PORCELLANATO TUTTA MASSA_FULL-BODY PORCELAIN STONEWARE



CODA DI PAVONE MAXI (MQ. 0,67)
(KIT 4 PZ.)
138x87,5x26,5 cm - 54"x34^{1/2}"x10^{1/2}"
9 mm

STRUTTURATO

ROSSO MISTO PGZP719



CODA DI PAVONE (MQ. 0,40)
(KIT 4 PZ.)
103x65x19 cm - 40^{1/2}"x25^{1/2}"x7^{1/2}"
9 mm

STRUTTURATO

ROSSO MISTO PGZP715

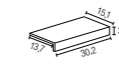

ELEMENTO "L"
15x30x4 cm - 6"x12"x1^{9/16}"
9 mm

STRUTTURATO

ROSSO MISTO PGZP7A1

1 Modulo
Module / Modul / Module

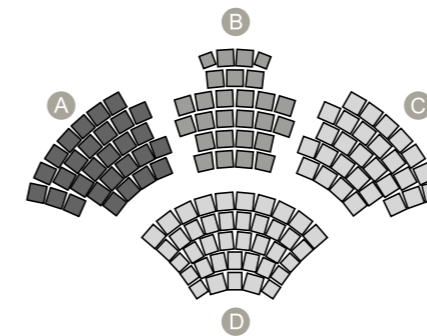

2 Montaggio
Assembly / Versammlung / Montage

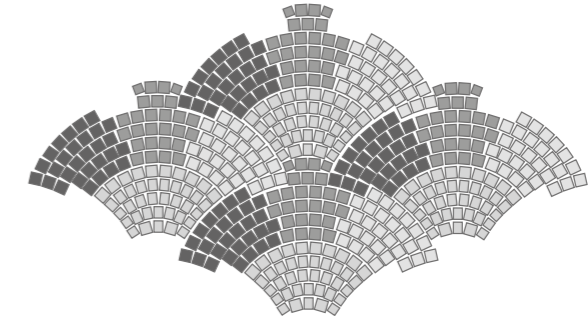

3 Risultato finale
Final Result / Endergebnis / Résultat Final

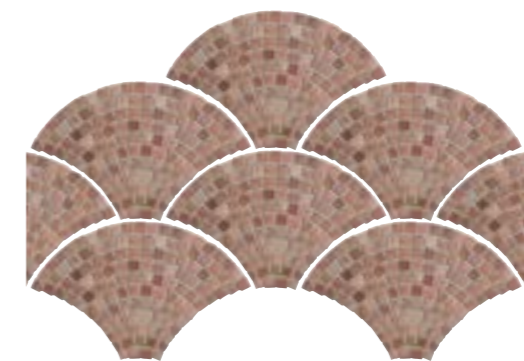
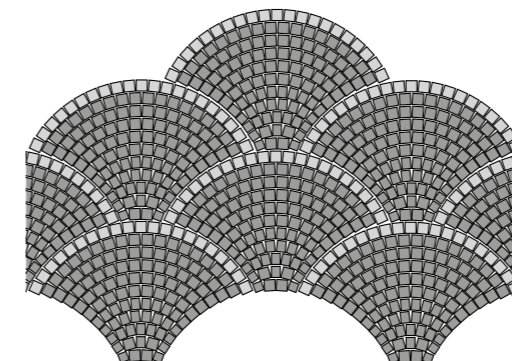

Trattandosi di pezzi artigianali possono verificarsi piccole variazioni dimensionali_Handmade pieces: light size variations may occur_Da es sich um handgemachte Teile handelt, können es kleine dimensionale Veränderungen auftreten_Étant donné qu'il s'agit de pièces faites à la main il peut y avoir des petits changements dimensionnels

IMBALLAGGI E PESI_PACKINGS AND WEIGHTS

DESCRIZIONE Description	9 mm	FORMATI Sizes	SCATOLA_Box				PALLET			
FONDO STRUTTURATO	9	20x20	30	25	1,2	-	45	1125	54	
FONDO STRUTTURATO	9	20x30,5	20	23,1	1,22	-	48	1109	58,56	
FONDO STRUTTURATO	9	20x41	13	21	1,066	-	54	1134	57,564	
CODA DI PAVONE MAXI STRUTTURATO	9	MODULO 4 PZ.	1	9,8	0,67	-	44	431	29,48	
CODA DI PAVONE STRUTTURATO	9	MODULO 4 PZ.	1	7	0,4	-	40	280	16	
ELEMENTO "L" STRUTTURATO	9	15x30x4	8	9,6	0,36	2,4	48	461	17,28	



Prime Stone



WHITE PRIME



SILVER PRIME



SAND PRIME



GREIGE PRIME

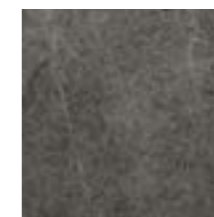

BLACK PRIME

GRES PORCELLANATO LAMINATO_LAMINATED PORCELAIN STONEWARE **Zero.3**



± 5,5 mm



100x300 cm Rect
39"x118"

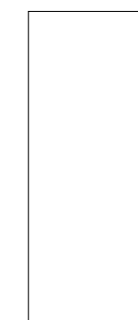

100x250 cm Rect
39"x98^{1/2}"

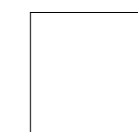

100x100 cm Rect
39"x39"



50x100 cm Rect
19^{1/2}"x39"

GRES PORCELLANATO A MASSA COLORATA_COLOURED-BODY PORCELAIN STONEWARE



± 9,5 mm



90x90 cm Rect
36"x36"



45x90 cm Rect
18"x36"



60x60 cm Rect
24"x24"



30x60 cm Rect
12"x24"

GRES PORCELLANATO A MASSA COLORATA_COLOURED-BODY PORCELAIN STONEWARE **20 mm**



± 20 mm



45x90 cm Rect
18"x36"



RIVESTIMENTO / WALL Sand Prime Naturale 100x250 cm Rect - 39"x98¹/₂"_Greige Prime Naturale 100x300 cm Rect - 39"x118"
PAVIMENTO / FLOOR Sand Prime Naturale 100x100 cm Rect - 39"x39"



RIVESTIMENTO / WALL Muretto Silver Prime Soft 30x60 cm Rect - 12"x24"
PAVIMENTO / FLOOR Black Prime Soft 45x90 cm Rect - 18"x36"



RIVESTIMENTO / WALL White Prime Naturale 100x300 cm Rect - 39"x118" _Black Prime Naturale 100x300 cm Rect - 39"x118"
PAVIMENTO / FLOOR Black Prime Naturale 50x100 cm Rect - 19 1/2"x39"
White Prime Naturale 100x100 cm Rect - 39"x39"



RIVESTIMENTO / WALL **White Prime Naturale** 100x300 cm Rect - 39"x118" 100x250 cm Rect - 39"x98^{1/2}"
 PAVIMENTO / FLOOR **Silver Prime Naturale** 100x300 cm Rect - 39"x118" 100x100 cm Rect - 39"x39"



RIVESTIMENTO / WALL **Greige Prime Naturale** 100x300 cm Rect - 39"x118"
 PAVIMENTO / FLOOR **Greige Prime Naturale** 100x100 cm Rect - 39"x39"



PAVIMENTO / FLOOR Greige Prime Strutturato 45x90 cm Rect - 18"x36" 20 mm

Prime Stone

PR()TECT
ANTIBATTERICO - ANTIMICROBIAL

WHITE PRIME



SILVER PRIME



SAND PRIME



GREIGE PRIME



BLACK PRIME



DESTINAZIONI D'USO_INTENDED USE: **NATURALE** **SOFT** **STRUTTURATO**

DATI TECNICI_TECHNICAL DATA:

GRES PORCELLANATO LAMINATO LAMINATED PORCELAIN STONEWARE		GRES A MASSA COLORATA COLOURED-BODY STONEWARE		GRES A MASSA COLORATA COLOURED-BODY STONEWARE		
5,5 mm		9,5 mm		20 mm		
DIN EN 16165 - Annex B: R9 Naturale BCR TORTUS: $\mu > 0,40$ Naturale ANSI A326.3: ID - DCOF $\geq 0,42$ (dry) Naturale IW - DCOF $\geq 0,42$ (wet) Naturale		DIN EN 16165 - Annex B: R9 Soft BCR TORTUS: $\mu > 0,40$ Soft ANSI A326.3: ID - DCOF $\geq 0,42$ (dry) Soft IW - DCOF $\geq 0,42$ (wet) Soft		DIN EN 16165 - Annex B: R11 Strutturato DIN EN 16165 - Annex A: C (A+B+C) Strutturato BCR TORTUS: $\mu > 0,40$ Strutturato ANSI A326.3: EW Strutturato AS/NZS 4586: P4 Strutturato BS 7976-2: PTV 36+WET (Sl.96 - Sl.55) Strutturato		
ANSI A137.3: V2 Naturale		ANSI A137.1: V2 Soft		ANSI A137.1: V2 Strutturato		
PR()TECT ANTIBATTERICO - ANTIMICROBIAL Naturale		PR()TECT ANTIBATTERICO - ANTIMICROBIAL Soft				

Prime Stone

GRES PORCELLANATO LAMINATO_LAMINATED PORCELAIN STONEWARE **Zero.3**



100x300 cm Rect - 39"x118"

White Prime NATURALE PZ7PM00
Silver Prime NATURALE PZ7PM20
Sand Prime NATURALE PZ7PM40
Greige Prime NATURALE PZ7PM30
Black Prime NATURALE PZ7PM10

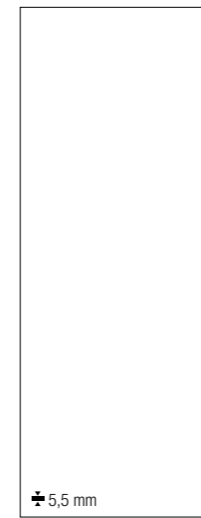

100x250 cm Rect - 39"x98"^{1/2}"

White Prime NATURALE PZ6PM00
Silver Prime NATURALE PZ6PM20
Sand Prime NATURALE PZ6PM40
Greige Prime NATURALE PZ6PM30
Black Prime NATURALE PZ6PM10

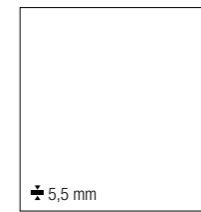

100x100 cm Rect - 39"x39"

White Prime NATURALE PZ8PM00
Silver Prime NATURALE PZ8PM20
Sand Prime NATURALE PZ8PM40
Greige Prime NATURALE PZ8PM30
Black Prime NATURALE PZ8PM10



50x100 cm Rect - 19"^{1/2}"x39"

White Prime NATURALE PZ9PM00
Silver Prime NATURALE PZ9PM20
Sand Prime NATURALE PZ9PM40
Greige Prime NATURALE PZ9PM30
Black Prime NATURALE PZ9PM10

GRES PORCELLANATO A MASSA COLORATA_COLOURED-BODY PORCELAIN STONEWARE



90x90 cm Rect - 36"x36"

White Prime SOFT PGGPM00G
Silver Prime SOFT PGGPM20G
Sand Prime SOFT PGGPM40G
Greige Prime SOFT PGGPM30G
Black Prime SOFT PGGPM10G

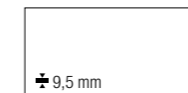

45x90 cm Rect - 18"x36"

White Prime SOFT PGHPM00G
Silver Prime SOFT PGHPM20G
Sand Prime SOFT PGHPM40G
Greige Prime SOFT PGHPM30G
Black Prime SOFT PGHPM10G

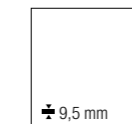

60x60 cm Rect - 24"x24"

White Prime SOFT PGWPM00
Silver Prime SOFT PGWPM20
Sand Prime SOFT PGWPM40
Greige Prime SOFT PGWPM30
Black Prime SOFT PGWPM10

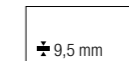

30x60 cm Rect - 12"x24"

White Prime SOFT PG-PM00
Silver Prime SOFT PG-PM20
Sand Prime SOFT PG-PM40
Greige Prime SOFT PG-PM30
Black Prime SOFT PG-PM10

GRES PORCELLANATO A MASSA COLORATA_COLOURED-BODY PORCELAIN STONEWARE **20 mm**

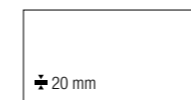

45x90 cm Rect - 18"x36"

Silver Prime STRUTTURATO* PGHPM21
Sand Prime STRUTTURATO* PGHPM41
Greige Prime STRUTTURATO* PGHPM31

* Protezione antibatterica non presente_No antimicrobial protection_Der Antibakterielle Schutz nicht vorhanden_Protection antibactérienne pas présente

Prime Stone

DECORI_DECORS

GRES PORCELLANATO A MASSA COLORATA_COLOURED-BODY PORCELAIN STONWARE

WHITE PRIME



MURETTO SOFT
30x60 cm Rect - 12"x24"
± 9,5 mm
PG-PMM0



MOSAICO 16 PEZZI SOFT
30x30 cm Rect - 12"x12"
± 9,5 mm
PGZPM00

SILVER PRIME



MURETTO SOFT
30x60 cm Rect - 12"x24"
± 9,5 mm
PG-PMM2



MOSAICO 16 PEZZI SOFT
30x30 cm Rect - 12"x12"
± 9,5 mm
PGZPM20

SAND PRIME



MURETTO SOFT
30x60 cm Rect - 12"x24"
± 9,5 mm
PG-PMM4



MOSAICO 16 PEZZI SOFT
30x30 cm Rect - 12"x12"
± 9,5 mm
PGZPM40

GREIGE PRIME



MURETTO SOFT
30x60 cm Rect - 12"x24"
± 9,5 mm
PG-PMM3



MOSAICO 16 PEZZI SOFT
30x30 cm Rect - 12"x12"
± 9,5 mm
PGZPM30

BLACK PRIME



MURETTO SOFT
30x60 cm Rect - 12"x24"
± 9,5 mm
PG-PMM1

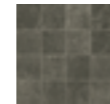

MOSAICO 16 PEZZI SOFT
30x30 cm Rect - 12"x12"
± 9,5 mm
PGZPM10

PEZZI SPECIALI_TRIM PIECES

GRES PORCELLANATO A MASSA COLORATA_COLOURED-BODY PORCELAIN STONWARE

BATTISCOPA 10x60 cm Rect - 4"x24" ± 9,5 mm SOFT	ANGOLO GRADONE A COSTA RETTA 34x34 cm - 13 ^{3/8} "x13 ^{3/8} " ± 9,5 mm SOFT	GRADONE A COSTA RETTA 30x34 cm Rect - 12"x13 ^{3/8} " ± 9,5 mm SOFT	BATTISCOPA SCALA DX (kit 2 pezzi) 10x45 cm - 4"x18" ± 10 mm SOFT	BATTISCOPA SCALA SX (kit 2 pezzi) 10x45 cm - 4"x18" ± 10 mm SOFT
WHITE PRIME PGRPM00A	PGEPM01	PGZPM00	PGZPM0D	PGZPM0S
SILVER PRIME PGRPM20A	PGZPM21	PGZPM20	PGZPM2D	PGZPM2S
SAND PRIME PGRPM40A	PGZPM41	PGZPM40	PGZPM4D	PGZPM4S
GREIGE PRIME PGRPM30A	PGZPM31	PGZPM30	PGZPM3D	PGZPM3S
BLACK PRIME PGRPM10A	PGZPM11	PGZPM10	PGZPM1D	PGZPM1S

GRES PORCELLANATO A MASSA COLORATA_COLOURED-BODY PORCELAIN STONWARE **20 mm**

COSTA TORO ANGOLARE DX 30x90 cm Rect - 12"x36" STRUTTURATO*	COSTA TORO ANGOLARE SX 30x90 cm Rect - 12"x36" STRUTTURATO*	COSTA TORO 30x90 cm Rect - 12"x36" STRUTTURATO*	COSTA TORO GRIP 30x90 cm Rect - 12"x36" STRUTTURATO*	COSTA RETTA ANGOLARE DX 30x90 cm Rect - 12"x36" STRUTTURATO*	COSTA RETTA ANGOLARE SX 30x90 cm Rect - 12"x36" STRUTTURATO*
SILVER PRIME PGDPMK2	PGDPMK7	PGFPMF2	PGFPMJ2	PGDPM2	PGDPM7
SAND PRIME PGDPMK4	PGDPMK9	PGFPMF4	PGFPMJ4	PGDPM4	PGDPM9
GREIGE PRIME PGDPMK3	PGDPMK6	PGFPMF3	PGFPMJ3	PGDPM3	PGDPM6
COSTA RETTA 30x90 cm Rect - 12"x36" STRUTTURATO*	COSTA RETTA GRIP 30x90 cm Rect - 12"x36" STRUTTURATO*	GRIGLIA ANGOLARE DX 15x45 cm Rect - 6"x18" STRUTTURATO*	GRIGLIA ANGOLARE SX 15x45 cm Rect - 6"x18" STRUTTURATO*	GRIGLIA 15x45 cm Rect - 6"x18" STRUTTURATO*	
SILVER PRIME PGFPMC2	PGFPMG2	PGDPA2	PGDPA7	PGDPM22	
SAND PRIME PGFPMC4	PGFPMG4	PGDPA4	PGDPA9	PGDPM24	
GREIGE PRIME PGFPMC3	PGFPMG3	PGDPA3	PGDPA6	PGDPM23	

* Protezione antibatterica non presente_No antimicrobial protection_Der Antibakterielle Schutz nicht vorhanden_Protection antibactérienne pas présente

Prime Stone

IMBALLAGGI E PESI_PACKINGS AND WEIGHTS

DESCRIZIONE Description	± mm	FORMATI Sizes	SCATOLA_Box				PALLET		
FONDO NATURALE	5,5	100x300 ^{RECT}	1	34,5	3	-	13	448,5	39
FONDO NATURALE	5,5	100x250 ^{RECT}	1	28,75	2,5	-	13	373,75	32,5
FONDO NATURALE	5,5	100x100 ^{RECT}	2	23	2	-	25	575	50
FONDO NATURALE	5,5	50x100 ^{RECT}	3	17,25	1,5	-	32	552	48
FONDO SOFT	9,5	90x90 ^{RECT}	2	33,6	1,62	-	25	840	40,5
FONDO SOFT	9,5	45x90 ^{RECT}	3	25,2	1,215	-	36	907,2	43,74
FONDO SOFT	9,5	60x60 ^{RECT}	4	31,8	1,44	-	32	1018	46,1
FONDO SOFT	9,5	30x60 ^{RECT}	8	31,8	1,44	-	32	1018	46,1
MOSAICO 16 PEZZI SOFT	9,5	30x30 ^{RECT}	4	7,2	0,36	-	78	562	28,1
MURETTO SOFT	9,5	30x60 ^{RECT}	4	15,7	0,72	-	30	471	21,6
BATTISCOPA SOFT	9,5	10x60 ^{RECT}	12	15	0,72	7,2	60	900	43,2
BATTISCOPA SCALA (KIT 2 PZ.) SOFT	10	10x45	5	8,5	0,43	-	-	-	-
GRADONE A COSTA RETTA SOFT	9,5	30x34 ^{RECT}	6	17,1	0,61	-	30	513	18,4
ANGOLO GRADONE A COSTA RETTA SOFT	9,5	34x34	2	6,3	0,23	-	48	301	11,1
FONDO STRUTTURATO	20	45x90 ^{RECT}	2	36,23	0,81	-	24	870	19,44
COSTA TORO STRUTTURATO	20	30x90 ^{RECT}	1	12,2	0,27	-	32	390	8,64
COSTA TORO ANGOLARE STRUTTURATO	20	30x90 ^{RECT}	1	10,2	0,23	-	32	326	7,2
COSTA TORO GRIP STRUTTURATO	20	30x90 ^{RECT}	1	12,2	0,27	-	32	390	8,64
COSTA RETTA STRUTTURATO	20	30x90 ^{RECT}	1	12,2	0,27	-	32	390	8,64
COSTA RETTA ANGOLARE STRUTTURATO	20	30x90 ^{RECT}	1	10,2	0,23	-	32	326	7,2
COSTA RETTA GRIP STRUTTURATO	20	30x90 ^{RECT}	1	12,2	0,27	-	32	390	8,64
GRIGLIA STRUTTURATO	20	15x45 ^{RECT}	4	11,2	0,27	-	48	538	12,96
GRIGLIA ANGOLARE STRUTTURATO	20	15x45 ^{RECT}	4	10	0,23	-	48	480	10,8



Stone Trace



GLADE



CREEK

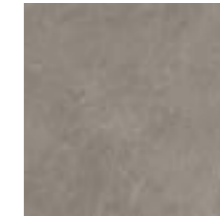

CREST



ABYSS



HOLLOW

GRES PORCELLANATO LAMINATO / LAMINATED PORCELAIN STONEWARE **Zero.3**



± 6 mm



120x278 cm Rect
48"x109^{1/2}"

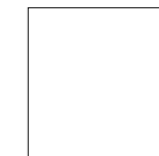

120x120 cm Rect
48"x48"



60x120 cm Rect
24"x48"



RIVESTIMENTO / WALL Crest Naturale 120x278 cm Rect - 48"x109^{1/2}"
PAVIMENTO / FLOOR Frame Peak Strutturato 45x90 cm Rect - 18"x36" 20 mm



RIVESTIMENTO / WALL Creek Naturale 120x278 cm Rect - 48"x109 1/2"
PAVIMENTO / FLOOR Creek Naturale 120x120 cm Rect - 48"x48"



RIVESTIMENTO / WALL Glade Naturale 120x278 cm Rect - 48"x109¹/₂"_Abyss Naturale 120x278 cm Rect - 48"x109¹/₂"_Glam Greenwall 50x100 cm Rect - 19¹/₂"x39"
 PAVIMENTO / FLOOR Abyss Naturale 60x120 cm Rect - 24"x48"



RIVESTIMENTO / WALL Glade Naturale 120x278 cm Rect - 48"x109¹/₂"
 PAVIMENTO / FLOOR Glade Naturale 60x120 cm Rect - 24"x48"
 TOP CUCINA E TAVOLO / COUNTERTOP AND TABLE Abyss Naturale



RIVESTIMENTO / WALL Hollow Naturale 120x278 cm Rect - 48"x109^{1/2}"
PAVIMENTO / FLOOR Hollow Naturale 120x120 cm Rect - 48"x48"

Stone Trace

P R () T E C T
ANTIBATTERICO - ANTIMICROBIAL

GLADE



CREEK



CREST



ABYSS



HOLLOW



Stone Trace

GRES PORCELLANATO LAMINATO / LAMINATED PORCELAIN STONEWARE **Zero.3**



120x278 cm Rect - 48"x109 1/2"

Glade NATURALE	PZ6ST30
Creek NATURALE	PZ6ST10
Crest NATURALE	PZ6ST20
Hollow NATURALE	PZ6ST40
Abbyss NATURALE	PZ6ST00

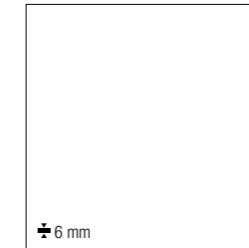

120x120 cm Rect - 48"x48"

Glade NATURALE	PZ8ST301
Creek NATURALE	PZ8ST101
Crest NATURALE	PZ8ST201
Hollow NATURALE	PZ8ST401
Abbyss NATURALE	PZ8ST001



60x120 cm Rect - 24"x48"

Glade NATURALE	PZXST30
Creek NATURALE	PZXST10
Crest NATURALE	PZXST20
Hollow NATURALE	PZXST40
Abbyss NATURALE	PZXST00

DESTINAZIONI D'USO / INTENDED USE: NATURALE

DATI TECNICI / TECHNICAL DATA:

GRES PORCELLANATO LAMINATO LAMINATED PORCELAIN STONEWARE	
6 mm	
DIN EN 16165 - Annex B: R10 Naturale	
BCR TORTUS: $\mu > 0,40$ Naturale	
ANSI A326.3: ID - DCOF $\geq 0,42$ (dry) Naturale	
IW - DCOF $\geq 0,42$ (wet) Naturale	
ANSI A137.3: V2 Naturale (Glade-Creek-Crest-Abbyss)	
V3 Naturale (Hollow)	
P R () T E C T ANTIBATTERICO - ANTIMICROBIAL	Naturale

IMBALLAGGI E PESI / PACKINGS AND WEIGHTS

DESCRIZIONE Description	mm	FORMATI Sizes	SCATOLA / Box				PALLET		
FONDO NATURALE	6	120x278 ^{RECT}	1	47	3,336	-	18	846	60,048
FONDO NATURALE	6	120x120 ^{RECT}	2	39,8	2,88	-	24	955,2	69,12
FONDO NATURALE	6	60x120 ^{RECT}	3	30,3	2,16	-	16	484,8	34,56



The Place



MIDTOWN WHITE



COUNTY BEIGE



SUBURB GREY

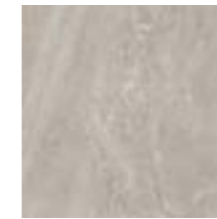

DISTRICT SMOKE

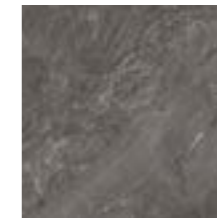

COTTAGE DARK

GRES PORCELLANATO A MASSA COLORATA_COLOURED-BODY PORCELAIN STONEWARE



± 9 mm
± 12 mm



90x90 cm Rect
36"x36"



60x120 cm Rect
24"x48"



60x60 cm Rect
24"x24"



30x60 cm Rect
12"x24"

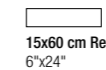

15x60 cm Rect
6"x24"

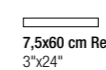

7,5x60 cm Rect
3"x24"

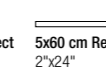

5x60 cm Rect
2"x24"



20x40,4 cm
8"x16"



20x30,2 cm
8"x12"



20x20 cm
8"x8"

GRES PORCELLANATO A MASSA COLORATA_COLOURED-BODY PORCELAIN STONEWARE **20 mm**



± 20 mm



60x120 cm Rect
24"x48"



Safetouch
Surface technology

THE PLACE - Superficie Naturale_Natural surface

L'unica superficie ceramica che coniuga la sicurezza di elevate prestazioni antiscivolamento ad una ruvidità superficiale ridotta ad effetto tattile morbido

The only ceramic surface that combines the safety of high slip resistance with reduced surface roughness and an effect that is soft to the touch



RUVIDITÀ RIDOTTA E SUPERFICIE MORBIDA AL TATTO
Reduced roughness and soft-touch surface



GRADO DI RESISTENZA ALLO SCIVOLAMENTO - R10
Slip resistance rating - R10



FACILE DA PULIRE E MANUTENERE
Easy to clean and maintain

RIVESTIMENTO / WALL County Beige Soft 15x60 cm Rect - 6"x24" _7,5x60 cm Rect - 3"x24" _5x60 cm Rect - 2"x24"
PAVIMENTO / FLOOR County Beige Soft 90x90 cm Rect - 36"x36"



RIVESTIMENTO / WALL Muretto District Smoke Soft 30x60 cm Rect - 12"x24"
PAVIMENTO / FLOOR District Smoke Naturale 60x120 cm Rect - 24"x48" _District Smoke Ext 60x120 cm Rect - 24"x48"



RIVESTIMENTO / WALL **Midtown White Naturale 60x120 cm Rect - 24"x48"**
Midtown White Naturale 15x60 cm Rect - 6"x24"_7,5x60 cm Rect - 3"x24"_5x60 cm Rect - 2"x24"
 PAVIMENTO / FLOOR **Cottage Dark Naturale 60x60 cm Rect - 24"x24"**



RIVESTIMENTO / WALL **Mosaico Cottage Dark Naturale 30x30 cm Rect - 12"x12"**
 PAVIMENTO / FLOOR **Midtown White Naturale 90x90 cm Rect - 36"x36"**
 TAVOLO / TABLE **Blade Rust Naturale**



RIVESTIMENTO / WALL Muretto Suburb Grey Naturale 30x60 cm Rect - 12"x24" _Midtown White 60x120 cm Rect - 24"x48"
PAVIMENTO / FLOOR Suburb Grey Naturale 90x90 cm Rect - 36"x36"



PAVIMENTO / FLOOR County Beige Strutturato 60x120 cm Rect - 24"x48" 20 mm



PAVIMENTO / FLOOR Cottage Dark Strutturato 20x20 cm - 8"x8" _20x30,2 cm - 8"x12" _20x40,4 cm - 8"x16"

The Place

PROTECT
ANTIBATTERICO - ANTIMICROBIAL

MIDTOWN WHITE



COUNTY BEIGE



SUBURB GREY



DISTRICT SMOKE



COTTAGE DARK



DESTINAZIONI D'USO_INTENDED USE: NATURALE SOFT STRUTTURATO / EXT

DATI TECNICI_TECHNICAL DATA:

GRES PORCELLANATO A MASSA COLORATA COLOURED-BODY PORCELAIN STONEWARE		GRES PORCELLANATO A MASSA COLORATA COLOURED-BODY PORCELAIN STONEWARE	
±	9 / 12 mm		20 mm
DIN EN 16165 - Annex B:	R10 Naturale R11 Ext - Strutturato	DIN EN 16165 - Annex B:	R11 Strutturato
DIN EN 16165 - Annex A:	B (A+B) Naturale C (A+B+C) Ext - Strutturato	DIN EN 16165 - Annex A:	C (A+B+C) Strutturato
BCR TORTUS: ANSI A326.3:	$\mu > 0,40$ Naturale - Ext - Strutturato ID - DCOF $\geq 0,42$ (dry) Naturale - Soft IW - DCOF $\geq 0,42$ (wet) Naturale IW+ Naturale* EW Ext - Strutturato	BCR TORTUS: ANSI A326.3: AS/NZS 4586: BS 7976-2:	EW Strutturato P4 Strutturato PTV 36+WET (SI.96 - SI.55) Strutturato
AS/NZS 4586:	P3 Naturale P4 Ext - Strutturato		
BS 7976-2:	PTV 36+WET (SI.96) Naturale PTV 36+WET (SI.96 - SI.55) Ext - Strutturato		
	V3 Naturale - Soft - Ext V4 Strutturato (solo/only Suburb Grey-Cottage Dark)	ANSI A137.1:	V3 Strutturato
PROTECT ANTIBATTERICO - ANTIMICROBIAL	Naturale - Soft		

* Ad eccezione delle zone caratterizzate da un maggior rischio di scivolamento (come docce pubbliche, piscine coperte, ecc.) per le quali si consiglia una superficie Ext - Strutturato
With the exception of areas characterized by a higher risk of slipping (such as public showers, indoor swimming pools, etc.) for which a Ext - Strutturato surface is recommended

The Place

GRES PORCELLANATO A MASSA COLORATA_COLOURED-BODY PORCELAIN STONEWARE

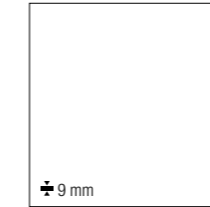

90x90 cm Rect - 36"x36"
Cottage Dark NATURALE PGGP900
County Beige NATURALE PGGP910
Suburb Grey NATURALE PGGP920
District Smoke NATURALE PGGP930
Midtown White NATURALE PGGP940
Cottage Dark SOFT PGGP9X0
County Beige SOFT PGGP9X1
Suburb Grey SOFT PGGP9X2
District Smoke SOFT PGGP9X3
Midtown White SOFT PGGP9X4



60x120 cm Rect - 24"x48"
Cottage Dark NATURALE PGXP900
County Beige NATURALE PGXP910
Suburb Grey NATURALE PGXP920
District Smoke NATURALE PGXP930
Midtown White NATURALE PGXP940
Cottage Dark SOFT PGXP9X0
County Beige SOFT PGXP9X1
Suburb Grey SOFT PGXP9X2
District Smoke SOFT PGXP9X3
Midtown White SOFT PGXP9X4
Cottage Dark EXT* PGXP905
County Beige EXT* PGXP915
Suburb Grey EXT* PGXP925
District Smoke EXT* PGXP935
Midtown White EXT* PGXP945



60x60 cm Rect - 24"x24"
Cottage Dark NATURALE PGWP900
County Beige NATURALE PGWP910
Suburb Grey NATURALE PGWP920
District Smoke NATURALE PGWP930
Midtown White NATURALE PGWP940
Cottage Dark SOFT PGWP9X0
County Beige SOFT PGWP9X1
Suburb Grey SOFT PGWP9X2
District Smoke SOFT PGWP9X3
Midtown White SOFT PGWP9X4
Cottage Dark EXT* PGWP905
County Beige EXT* PGWP915
Suburb Grey EXT* PGWP925
District Smoke EXT* PGWP935
Midtown White EXT* PGWP945



30x60 cm Rect - 12"x24"
Cottage Dark NATURALE PG-P900
County Beige NATURALE PG-P910
Suburb Grey NATURALE PG-P920
District Smoke NATURALE PG-P930
Midtown White NATURALE PG-P940
Cottage Dark SOFT PG-P9X0
County Beige SOFT PG-P9X1
Suburb Grey SOFT PG-P9X2
District Smoke SOFT PG-P9X3
Midtown White SOFT PG-P9X4
Cottage Dark EXT* PG-P905
County Beige EXT* PG-P915
Suburb Grey EXT* PG-P925
District Smoke EXT* PG-P935
Midtown White EXT* PG-P945



15x60 cm Rect - 6"x24"
Cottage Dark NATURALE PG1P950
County Beige NATURALE PG1P960
Suburb Grey NATURALE PG1P970
District Smoke NATURALE PG1P980
Midtown White NATURALE PG1P990
Cottage Dark SOFT PG1P900
County Beige SOFT PG1P910
Suburb Grey SOFT PG1P920
District Smoke SOFT PG1P930
Midtown White SOFT PG1P940

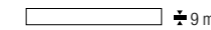

7,5x60 cm Rect - 3"x24"
Cottage Dark NATURALE PGRP975
County Beige NATURALE PGRP976
Suburb Grey NATURALE PGRP977
District Smoke NATURALE PGRP978
Midtown White NATURALE PGRP979
Cottage Dark SOFT PGRP970
County Beige SOFT PGRP971
Suburb Grey SOFT PGRP972
District Smoke SOFT PGRP973
Midtown White SOFT PGRP974



5x60 cm Rect - 2"x24"
Cottage Dark NATURALE PGRP955
County Beige NATURALE PGRP956
Suburb Grey NATURALE PGRP957
District Smoke NATURALE PGRP958
Midtown White NATURALE PGRP959
Cottage Dark SOFT PGRP950
County Beige SOFT PGRP951
Suburb Grey SOFT PGRP952
District Smoke SOFT PGRP953
Midtown White SOFT PGRP954



20x40,4 cm - 8"x16"
Cottage Dark STRUTTURATO* PGKP900
County Beige STRUTTURATO* PGKP910
Suburb Grey STRUTTURATO* PGKP920



20x30,2 cm - 8"x12"
Cottage Dark STRUTTURATO* PGBP900
County Beige STRUTTURATO* PGBP910
Suburb Grey STRUTTURATO* PGBP920



20x20 cm - 8"x8"
Cottage Dark STRUTTURATO* PGPE900
County Beige STRUTTURATO* PGPE910
Suburb Grey STRUTTURATO* PGPE920

GRES PORCELLANATO A MASSA COLORATA_COLOURED-BODY PORCELAIN STONEWARE 20 mm

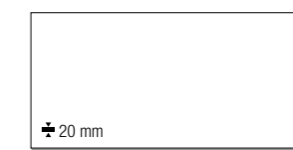

60x120 cm Rect - 24"x48"
Cottage Dark STRUTTURATO* PGXP950
County Beige STRUTTURATO* PGXP960
Suburb Grey STRUTTURATO* PGXP970
District Smoke STRUTTURATO* PGXP980
Midtown White STRUTTURATO* PGXP990

SOLUZIONI DI POSA OUTDOOR_OUTDOOR LAYING SOLUTIONS 12 mm

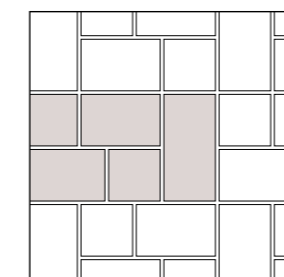

20x40,4 (28,69%) - 20x30,2 (42,90%) - 20x20 (28,41%)

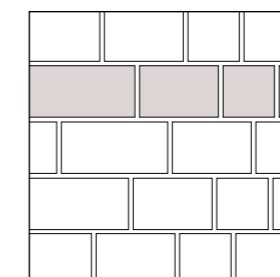

20x40,4 (44,59%) - 20x30,2 (33,33%) - 20x20 (22,08%)

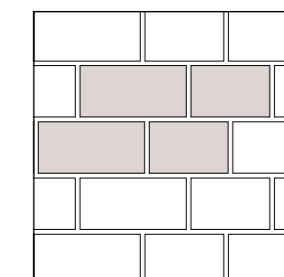

20x30,2 (42,78%) - 20x40,4 (57,22%)

Fuga consigliata: vedi pag. 419_Suggested joint: see pag. 419_Empfohlene Fuge: siehe Seite 419_Joint conseillé : voir page 419

* Protezione antibatterica non presente_No antimicrobial protection_Der Antibakterielle Schutz nicht vorhanden_Protection antibactérienne pas présente

The Place

DECORI_DECORS

GRES PORCELLANATO A MASSA COLORATA_COLOURED-BODY PORCELAIN STONEWARE

MIDTOWN WHITE	COUNTY BEIGE	SUBURB GREY	DISTRICT SMOKE	COTTAGE DARK
MURETTO SOFT 30x60 cm Rect - 12"x24" ± 9 mm PG-P9M4	MURETTO SOFT 30x60 cm Rect - 12"x24" ± 9 mm PG-P9M1	MURETTO SOFT 30x60 cm Rect - 12"x24" ± 9 mm PG-P9M2	MURETTO SOFT 30x60 cm Rect - 12"x24" ± 9 mm PG-P9M3	MURETTO SOFT 30x60 cm Rect - 12"x24" ± 9 mm PG-P9M0
CHEVRON NATURALE 14,5x49,8 cm Rect - 5 ^{3/4} "x19 ^{1/2} " ± 9 mm PGZP9C4	CHEVRON NATURALE 14,5x49,8 cm Rect - 5 ^{3/4} "x19 ^{1/2} " ± 9 mm PGZP9C1	CHEVRON NATURALE 14,5x49,8 cm Rect - 5 ^{3/4} "x19 ^{1/2} " ± 9 mm PGZP9C2	CHEVRON NATURALE 14,5x49,8 cm Rect - 5 ^{3/4} "x19 ^{1/2} " ± 9 mm PGZP9C3	CHEVRON NATURALE 14,5x49,8 cm Rect - 5 ^{3/4} "x19 ^{1/2} " ± 9 mm PGZP9C0
MOSAICO 36 PEZZI NATURALE / SOFT 30x30 cm Rect - 12"x12" ± 9 mm PGZP9M4 NATURALE PGZP9S4 SOFT	MOSAICO 36 PEZZI NATURALE / SOFT 30x30 cm Rect - 12"x12" ± 9 mm PGZP9M1 NATURALE PGZP9S1 SOFT	MOSAICO 36 PEZZI NATURALE / SOFT 30x30 cm Rect - 12"x12" ± 9 mm PGZP9M2 NATURALE PGZP9S2 SOFT	MOSAICO 36 PEZZI NATURALE / SOFT 30x30 cm Rect - 12"x12" ± 9 mm PGZP9M3 NATURALE PGZP9S3 SOFT	MOSAICO 36 PEZZI NATURALE / SOFT 30x30 cm Rect - 12"x12" ± 9 mm PGZP9M0 NATURALE PGZP9S0 SOFT

PEZZI SPECIALI_TRIM PIECES

GRES PORCELLANATO A MASSA COLORATA_COLOURED-BODY PORCELAIN STONEWARE

BATTISCOPIA 7,5x60 cm Rect - 3"x24" ± 9 mm NATURALE	BATTISCOPIA 7,5x60 cm Rect - 3"x24" ± 9 mm SOFT	GRADONE A COSTA RETTA 30x34 cm Rect - 12"x13 ^{3/8} " ± 9 mm NATURALE	ANGOLO GRADONE A COSTA RETTA 34x34 cm - 13 ^{3/8} "x13 ^{3/8} " ± 9 mm NATURALE
COTTAGE DARK PGRP900A	PGRP900	PGEP900	PGEP901
COUNTY BEIGE PGRP910A	PGRP9X1	PGEP910	PGEP911
SUBURB GREY PGRP920A	PGRP9X2	PGEP920	PGEP921
DISTRICT SMOKE PGRP930A	PGRP9X3	PGEP930	PGEP931
MIDTOWN WHITE PGRP940A	PGRP9X4	PGEP940	PGEP941
BATTISCOPIA SCALA DX (kit 2 pezzi) 7,5x45 cm - 3"x18" ± 8 mm NATURALE	BATTISCOPIA SCALA SX (kit 2 pezzi) 7,5x45 cm - 3"x18" ± 8 mm NATURALE	ELEMENTO "L" MONOBLOCCO 15x30x4 cm - 6"x12"x1 ^{9/16} " ± 12 mm STRUTTURATO*	ELEMENTO "L" 15x30x4 cm Rect - 6"x12"x1 ^{9/16} " ± 9 mm EXT*
COTTAGE DARK PGZP90D	PGZP90S	PGZP900	PGZP9L0
COUNTY BEIGE PGZP91D	PGZP91S	PGZP910	PGZP9L1
SUBURB GREY PGZP92D	PGZP92S	PGZP920	PGZP9L2
DISTRICT SMOKE PGZP93D	PGZP93S	/	PGZP9L3
MIDTOWN WHITE PGZP94D	PGZP94S	/	PGZP9L4

ELEMENTO "L" MONOBLOCCO:

Abbinabile alla finitura Strutturato_To be used with Strutturato version_Kombinierbar mit Finish Strutturato_Combinable à la finition Strutturato

ELEMENTO "L":

Realizzato tramite incollaggio_Made by gluing_Hergestellt durch Kleben_Réalisé par collage

Abbinabile alla finitura Ext_To be used with Ext version_Kombinierbar mit Finish Ext_Combinable à la finition Ext

* Protezione antibatterica non presente_No antimicrobial protection_Der Antibakterielle Schutz nicht vorhanden_Protection antibactérienne pas présente

The Place

PEZZI SPECIALI_TRIM PIECES

GRES PORCELLANATO A MASSA COLORATA_COLOURED-BODY PORCELAIN STONEWARE **20 mm**

COSTA TORO ANGOLARE DX 30x60 cm Rect - 12"x24" STRUTTURATO*	COSTA TORO ANGOLARE SX 30x60 cm Rect - 12"x24" STRUTTURATO*	COSTA TORO 30x60 cm Rect - 12"x24" STRUTTURATO*	COSTA TORO GRIP 30x60 cm Rect - 12"x24" STRUTTURATO*	COSTA RETTA ANGOLARE DX 30x60 cm Rect - 12"x24" STRUTTURATO*	COSTA RETTA ANGOLARE SX 30x60 cm Rect - 12"x24" STRUTTURATO*
COTTAGE DARK PGDP9K0	PGDP9K1	PGDP9F0	PGDP9J0	PGDP9D0	PGDP9D1
COUNTY BEIGE PGDP9K2	PGDP9K3	PGDP9F1	PGDP9J1	PGDP9D2	PGDP9D3
SUBURB GREY PGDP9K4	PGDP9K5	PGDP9F2	PGDP9J2	PGDP9D4	PGDP9D5
DISTRICT SMOKE PGDP9K6	PGDP9K7	PGDP9F3	PGDP9J3	PGDP9D6	PGDP9D7
MIDTOWN WHITE PGDP9K8	PGDP9K9	PGDP9F4	PGDP9J4	PGDP9D8	PGDP9D9
COSTA RETTA 30x60 cm Rect - 12"x24" STRUTTURATO*	COSTA RETTA GRIP 30x60 cm Rect - 12"x24" STRUTTURATO*	GRIGLIA ANGOLARE DX 15x60 cm Rect - 6"x24" STRUTTURATO*	GRIGLIA ANGOLARE SX 15x60 cm Rect - 6"x24" STRUTTURATO*	GRIGLIA 15x60 cm Rect - 6"x24" STRUTTURATO*	
COTTAGE DARK PGDP9C0	PGDP9G0	PG1P9A0	PG1P9A1	PGDP9Z0	
COUNTY BEIGE PGDP9C1	PGDP9G1	PG1P9A2	PG1P9A3	PGDP9Z1	
SUBURB GREY PGDP9C2	PGDP9G2	PG1P9A4	PG1P9A5	PGDP9Z2	
DISTRICT SMOKE PGDP9C3	PGDP9G3	PG1P9A6	PG1P9A7	PGDP9Z3	
MIDTOWN WHITE PGDP9C4	PGDP9G4	PG1P9A8	PG1P9A9	PGDP9Z4	

* Protezione antibatterica non presente_No antimicrobial protection_Der Antibakterielle Schutz nicht vorhanden_Protection antibactérienne pas présente

IMBALLAGGI E PESI_PACKINGS AND WEIGHTS

DESCRIZIONE Description	± mm	FORMATI Sizes	SCATOLA_Box			PALLET			
			Box	KG	M ²	ML	Box	KG	M ²
FONDO NATURALE / SOFT / EXT	9	60x120 ^{RECT}	2	31,8	1,44	-	36	1144,8	51,84
FONDO NATURALE / SOFT	9	90x90 ^{RECT}	2	33,6	1,62	-	25	840	40,5
FONDO NATURALE / SOFT / EXT	9	60x60 ^{RECT}	4	30,5	1,44	-	32	976	46,08
FONDO NATURALE / SOFT / EXT	9	30x60 ^{RECT}	9	35	1,62	-	32	1120	51,84
FONDO NATURALE / SOFT	9	15x60 ^{RECT}	14	27,75	1,26	-	40	1110	50,4
FONDO NATURALE / SOFT	9	7,5x60 ^{RECT}	14	13	0,63	-	60	780	37,8
FONDO NATURALE / SOFT	9	5x60 ^{RECT}	12	7,5	0,36	-	50	375	18
FONDO STRUTTURATO	12	20x40,4	10	21	0,808	-	54	1134	43,632
FONDO STRUTTURATO	12	20x30,2	15	23,1	0,906	-	48	1108,8	43,488
FONDO STRUTTURATO	12	20x20	22	22,2	0,88	-	45	999	39,6
CHEVRON NATURALE	9	14,5x49,8 ^{RECT}	14	22,2	1,0109	-	32	710,4	32,35
MURETTO SOFT	9	30x60 ^{RECT}	4	15,6	0,72	-	30	468	21,6
MOSAICO 36 PEZZI NATURALE / SOFT	9	30x30 ^{RECT}	5	9	0,45	-	60	540	27
BATTISCOPIA NATURALE / SOFT	9	7,5x60 ^{RECT}	12	11,61	0,54	7,2	60	696,6	32,4
BATTISCOPIA SCALA (KIT 2 PZ.) NATURALE	8	7,5x45	5	7,5	0,337	-	-	-	-
GRADONE A COSTA RETTA NATURALE	9	30x34 ^{RECT}	6	19,95	0,612	-	30	598,5	18,36
ANGOLO GRADONE A COSTA RETTA NATURALE	9	34x34	2	6,27	0,231	-	48	300,96	11,097
ELEMENTO "L" EXT	9	15x30x4 ^{RECT}	8	8,74	0,36	2,4	48	419,52	17,28
ELEMENTO "L" MONOBLOCCO STRUTTURATO	12	15x30x4	8	12	0,36	2,4	44	528	15,84
FONDO STRUTTURATO	20	60x120 ^{RECT}	1	32,5	0,72	-	36	1170	25,92
COSTA TORO STRUTTURATO	20	30x60 ^{RECT}	1	8,125	0,18	-	100	812,5	18
COSTA TORO ANGOLARE STRUTTURATO	20	30x60 ^{RECT}	1	6,1	0,135	-	100	610	13,5
COSTA TORO GRIP STRUTTURATO	20	30x60 ^{RECT}	1	8,125	0,18	-	100	812,5	18
COSTA RETTA STRUTTURATO	20	30x60 ^{RECT}	1	8,125	0,18	-	100	812,5	18
COSTA RETTA ANGOLARE STRUTTURATO	20	30x60 ^{RECT}	1	6,1	0,135	-	100	610	13,5
COSTA RETTA GRIP STRUTTURATO	20	30x60 ^{RECT}	1	8,125	0,18	-	100	812,5	18
GRIGLIA STRUTTURATO	20	15x60 ^{RECT}	2	8	0,18	-	100	800	18
GRIGLIA ANGOLARE STRUTTURATO	20	15x60 ^{RECT}	2	7	0,157	-	100	700	15,75



Via Maestra



PERCORSI



TRAGITTI

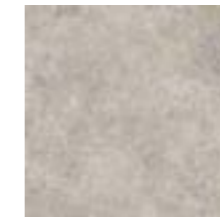

CAMMINI



PAESAGGI

GRES PORCELLANATO A MASSA COLORATA_COLOURED-BODY PORCELAIN STONEWARE



± 9 mm



120x120 cm Rect
48"x48"



60x120 cm Rect
24"x48"



60x60 cm Rect
24"x24"



40x60 cm Rect
16"x24"



30x60 cm Rect
12"x24"

GRES PORCELLANATO A MASSA COLORATA_COLOURED-BODY PORCELAIN STONEWARE **20 mm**



± 20 mm



60x90 cm Rect
24"x36"



RIVESTIMENTO / WALL Muretto Percorsi Naturale 30x60 cm Rect - 12"x24"
PAVIMENTO / FLOOR Percorsi Naturale 60x120 cm Rect - 24"x48" _Cammini Strutturato 60x90 cm Rect - 24"x36" 20 mm



RIVESTIMENTO / WALL Tragitti Naturale 60x120 cm Rect - 24"x48" _Intarsi Tragitti Naturale 60x120 cm Rect - 24"x48"
PAVIMENTO / FLOOR Tragitti Naturale 60x60 cm Rect - 24"x24"



RIVESTIMENTO / WALL Foglia Oro Percorsi 60x120 cm Rect - 24"x48"



PAVIMENTO / FLOOR Cammini Strutturato 60x60 cm Rect - 24"x24" _40x60 cm Rect - 16"x24" _30x60 cm Rect - 12"x24"



RIVESTIMENTO / WALL Foglia Argento Paesaggi 60x120 cm Rect - 24"x48" _Muretto Paesaggi Naturale 30x60 cm Rect - 12"x24"
PAVIMENTO / FLOOR Paesaggi Naturale 120x120 cm Rect - 48"x48"



PAVIMENTO / FLOOR Paesaggi Strutturato 60x90 cm Rect - 24"x36" 20 mm

PERCORSI



TRAGITTI



CAMMINI



PAESAGGI



GRES PORCELLANATO A MASSA COLORATA_COLOURED-BODY PORCELAIN STONWARE

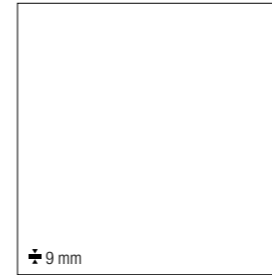

120x120 cm Rect - 48"x48"

Percorsi NATURALE	PG8HR10
Tragitti NATURALE	PG8HR00
Cammini NATURALE	PG8HR30
Paesaggi NATURALE	PG8HR20



60x120 cm Rect - 24"x48"

Percorsi NATURALE	PGXHR10
Tragitti NATURALE	PGXHR00
Cammini NATURALE	PGXHR30
Paesaggi NATURALE	PGXHR20



60x60 cm Rect - 24"x24"

Percorsi NATURALE	PGWHR10
Tragitti NATURALE	PGWHR00
Cammini NATURALE	PGWHR30
Paesaggi NATURALE	PGWHR20

Percorsi STRUTTURATO*	PGXHR15
Tragitti STRUTTURATO*	PGXHR05
Cammini STRUTTURATO*	PGXHR35
Paesaggi STRUTTURATO*	PGXHR25

Percorsi STRUTTURATO*	PGWHR15
Tragitti STRUTTURATO*	PGWHR05
Cammini STRUTTURATO*	PGWHR35
Paesaggi STRUTTURATO*	PGWHR25

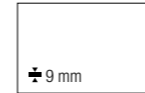

40x60 cm Rect - 16"x24"

Percorsi STRUTTURATO*	PGJHR15
Tragitti STRUTTURATO*	PGJHR05
Cammini STRUTTURATO*	PGJHR35
Paesaggi STRUTTURATO*	PGJHR25

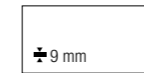

30x60 cm Rect - 12"x24"

Percorsi NATURALE	PG-HR10
Tragitti NATURALE	PG-HR00
Cammini NATURALE	PG-HR30
Paesaggi NATURALE	PG-HR20

Percorsi STRUTTURATO*	PG-HR15
Tragitti STRUTTURATO*	PG-HR05
Cammini STRUTTURATO*	PG-HR35
Paesaggi STRUTTURATO*	PG-HR25

GRES PORCELLANATO A MASSA COLORATA_COLOURED-BODY PORCELAIN STONWARE 20 mm

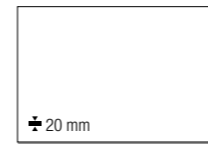

60x90 cm Rect - 24"x36"

Percorsi STRUTTURATO*	PG9HR10G
Tragitti STRUTTURATO*	PG9HR00G
Cammini STRUTTURATO*	PG9HR30G
Paesaggi STRUTTURATO*	PG9HR20G

MODULI_MODULES

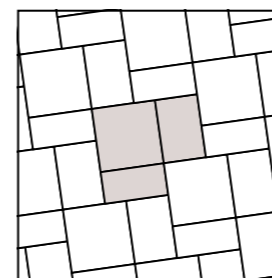

MODULO 1_3 FORMATI_SIZES

60x60 cm = 46,15%
40x60 cm = 30,77%
30x60 cm = 23,08%

Percorsi	PGZHRP1
Tragitti	PGZHRT1
Cammini	PGZHRC1
Paesaggi	PGZHRG1

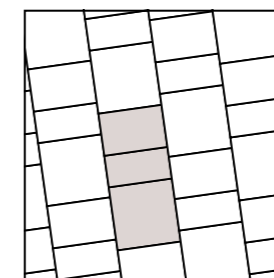

MODULO 2_3 FORMATI_SIZES

60x60 cm = 46,15%
40x60 cm = 30,77%
30x60 cm = 23,08%

Percorsi	PGZHRP2
Tragitti	PGZHRT2
Cammini	PGZHRC2
Paesaggi	PGZHRG2

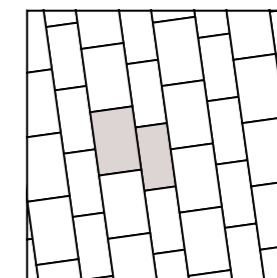

MODULO 3_2 FORMATI_SIZES

40x60 cm = 57,14%
30x60 cm = 42,86%

Percorsi	PGZHRP3
Tragitti	PGZHRT3
Cammini	PGZHRC3
Paesaggi	PGZHRG3

DESTINAZIONI D'USO_INTENDED USE: NATURALE STRUTTURATO

DATI TECNICI_TECHNICAL DATA:

GRES PORCELLANATO A MASSA COLORATA COLOURED-BODY PORCELAIN STONWARE		GRES PORCELLANATO A MASSA COLORATA COLOURED-BODY PORCELAIN STONWARE	
9 mm		20 mm	
DIN EN 16165 - Annex B: R10 Naturale R11 Strutturato		DIN EN 16165 - Annex B: R11 Strutturato	
DIN EN 16165 - Annex A: B (A+B) Naturale C (A+B+C) Strutturato		DIN EN 16165 - Annex A: C (A+B+C) Strutturato	
BCR TORTUS: ANSI A326.3: $\mu > 0,40$ Naturale - Strutturato ID - DCOF $\geq 0,42$ (dry) Naturale IW - DCOF $\geq 0,42$ (wet) Naturale IW+ Naturale* EW Strutturato		BCR TORTUS: ANSI A326.3: $\mu > 0,40$ Strutturato EW Strutturato P4 Strutturato	
AS/NZS 4586: P3 Naturale P4 Strutturato		AS/NZS 4586: P4 Strutturato	
BS 7976-2: PTV 36+WET (SI.96) Naturale PTV 36+WET (SI.96 - SI.55) Strutturato		BS 7976-2: PTV 36+WET (SI.96 - SI.55) Strutturato	
ANSI A137.1: V3 Naturale - Strutturato		ANSI A137.1: V3 Strutturato	
PROTECT ANTIBATTERICO - ANTIMICROBIAL	Naturale		

* Ad eccezione delle zone caratterizzate da un maggior rischio di scivolamento (come docce pubbliche, piscine coperte, ecc.) per le quali si consiglia una superficie Strutturato
With the exception of areas characterized by a higher risk of slipping (such as public showers, indoor swimming pools, etc.) for which a Strutturato surface is recommended

* Protezione antibatterica non presente_No antimicrobial protection_Der Antibakterielle Schutz nicht vorhanden_Protection antibactérienne pas présente

Via Maestra

SOLUZIONI DI POSA INDOOR_INDOOR LAYING SOLUTIONS

GRES PORCELLANATO A MASSA COLORATA_COLOURED-BODY PORCELAIN STONEWARE

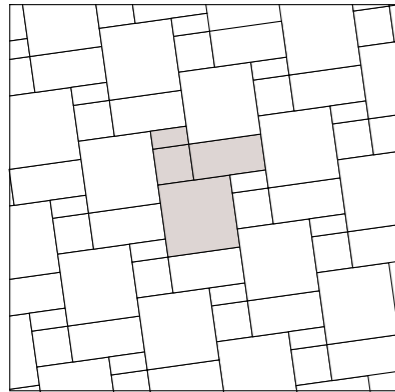

MODULO_MODULE 1
4 FORMATI_SIZES %

120x120 cm - 48"x48"	53,33
60x120 cm - 24"x48"	26,67
60x60 cm - 24"x24"	13,33
30x60 cm - 12"x24"	6,67

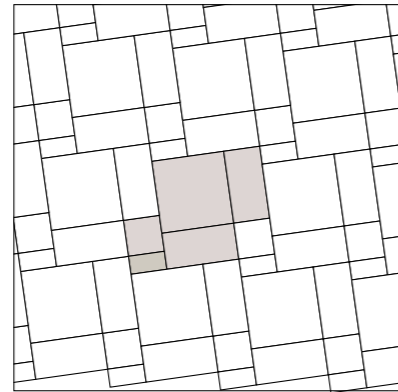

MODULO_MODULE 2
4 FORMATI_SIZES %

120x120 cm - 48"x48"	42,11
60x120 cm - 24"x48"	42,11
60x60 cm - 24"x24"	10,52
30x60 cm - 12"x24"	5,26

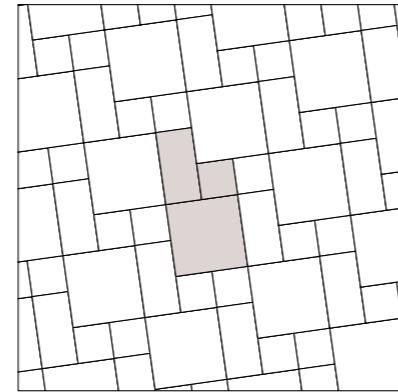

MODULO_MODULE 3
3 FORMATI_SIZES %

120x120 cm - 48"x48"	57,14
60x120 cm - 24"x48"	28,57
60x60 cm - 24"x24"	14,29

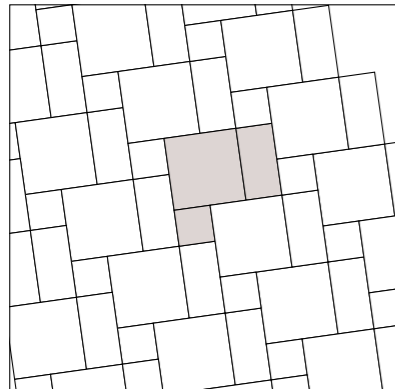

MODULO_MODULE 4
3 FORMATI_SIZES %

120x120 cm - 48"x48"	57,14
60x120 cm - 24"x48"	28,57
60x60 cm - 24"x24"	14,29

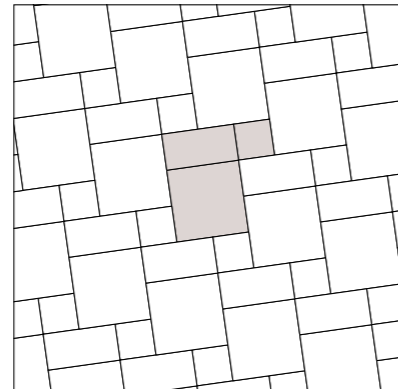

MODULO_MODULE 5
3 FORMATI_SIZES %

120x120 cm - 48"x48"	57,14
60x120 cm - 24"x48"	28,57
60x60 cm - 24"x24"	14,29

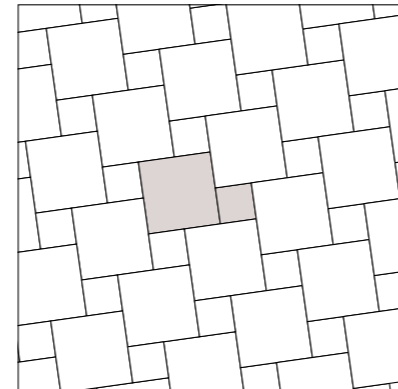

MODULO_MODULE 6
2 FORMATI_SIZES %

120x120 cm - 48"x48"	80,00
60x60 cm - 24"x24"	20,00

Via Maestra

SOLUZIONI DI POSA OUTDOOR_OUTDOOR LAYING SOLUTIONS

GRES PORCELLANATO A MASSA COLORATA_COLOURED-BODY PORCELAIN STONEWARE

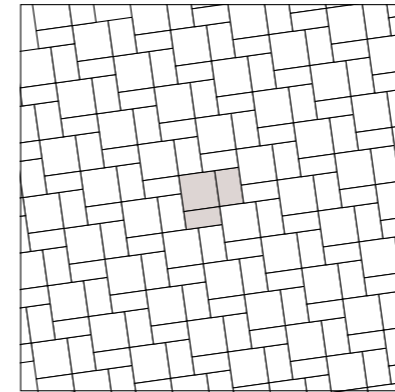

MODULO_MODULE 1
3 FORMATI_SIZES %

60x60 cm - 24"x24"	46,15
40x60 cm - 16"x24"	30,77
30x60 cm - 12"x24"	23,08

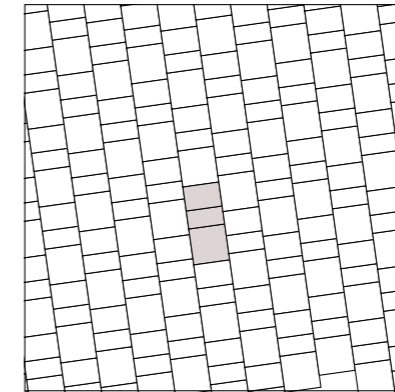

MODULO_MODULE 2
3 FORMATI_SIZES %

60x60 cm - 24"x24"	46,15
40x60 cm - 16"x24"	30,77
30x60 cm - 12"x24"	23,08

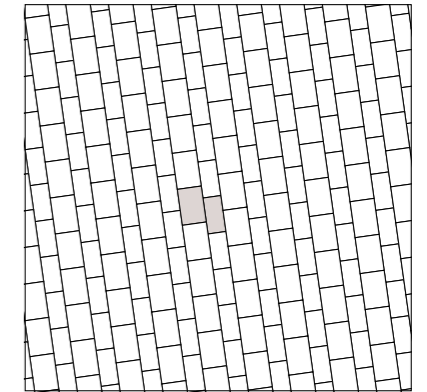

MODULO_MODULE 3
2 FORMATI_SIZES %

40x60 cm - 16"x24"	57,14
30x60 cm - 12"x24"	42,86

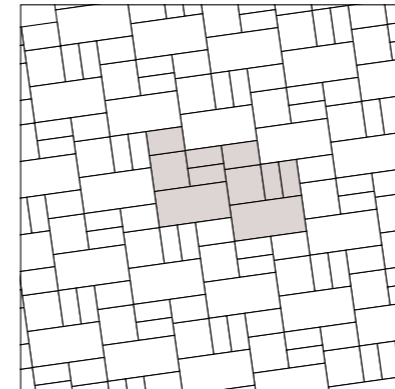

MODULO_MODULE 4
4 FORMATI_SIZES %

60x120 cm - 24"x48"	42,86
60x60 cm - 24"x24"	21,43
40x60 cm - 16"x24"	14,28
30x60 cm - 12"x24"	21,43

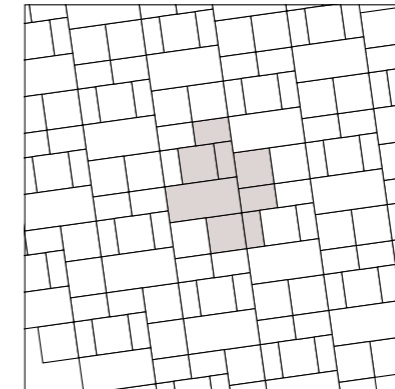

MODULO_MODULE 5
4 FORMATI_SIZES %

60x120 cm - 24"x48"	27,27
60x60 cm - 24"x24"	40,91
40x60 cm - 16"x24"	18,18
30x60 cm - 12"x24"	13,64

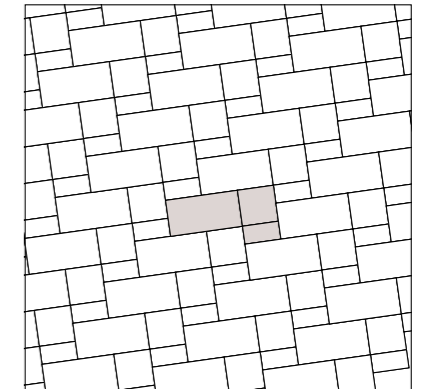

MODULO_MODULE 6
3 FORMATI_SIZES %

60x120 cm - 24"x48"	57,14
60x60 cm - 24"x24"	28,57
30x60 cm - 12"x24"	14,29

Via Maestra

DECORI_DECORS

GRES PORCELLANATO A MASSA COLORATA_COLOURED-BODY PORCELAIN STONEWARE

PERCORSI



MURETTO NATURALE
30x60 cm Rect - 12"x24"
± 9 mm
PGZHRM1



MOSAICO 16 PEZZI NATURALE
30x30 cm Rect - 12"x12"
± 9 mm
PGZHR10

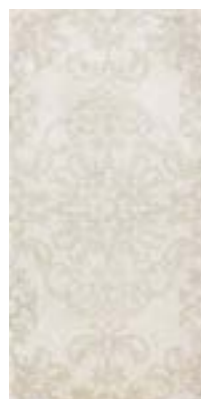

INTARSI NATURALE
60x120 cm Rect - 24"x48"
± 9 mm
PGXHR61



FOGLIA ORO*
60x120 cm Rect - 24"x48"
± 9 mm
PGXHR51

TRAGITTI



MURETTO NATURALE
30x60 cm Rect - 12"x24"
± 9 mm
PGZHRM0



MOSAICO 16 PEZZI NATURALE
30x30 cm Rect - 12"x12"
± 9 mm
PGZHR00

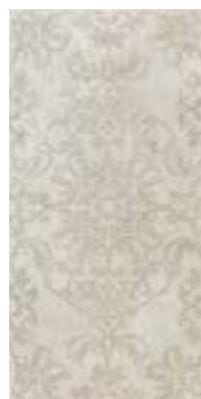

INTARSI NATURALE
60x120 cm Rect - 24"x48"
± 9 mm
PGXHR60



FOGLIA ORO*
60x120 cm Rect - 24"x48"
± 9 mm
PGXHR50

CAMMINI



MURETTO NATURALE
30x60 cm Rect - 12"x24"
± 9 mm
PGZHRM3



MOSAICO 16 PEZZI NATURALE
30x30 cm Rect - 12"x12"
± 9 mm
PGZHR30



INTARSI NATURALE
60x120 cm Rect - 24"x48"
± 9 mm
PGXHR63



FOGLIA ARGENTO*
60x120 cm Rect - 24"x48"
± 9 mm
PGXHR53

PAESAGGI



MURETTO NATURALE
30x60 cm Rect - 12"x24"
± 9 mm
PGZHRM2



MOSAICO 16 PEZZI NATURALE
30x30 cm Rect - 12"x12"
± 9 mm
PGZHR20



INTARSI NATURALE
60x120 cm Rect - 24"x48"
± 9 mm
PGXHR62



FOGLIA ARGENTO*
60x120 cm Rect - 24"x48"
± 9 mm
PGXHR52

INTARSI - FOGLIA ORO - FOGLIA ARGENTO:

Posare solo a parete_Recommended only for wall applications_Nur an der Wand verlegen_Recommandé seulement pour les revêtements

* Protezione antibatterica non presente_No antimicrobial protection_Der Antibakterielle Schutz nicht vorhanden_Protection antibactérienne pas présente

Via Maestra

PEZZI SPECIALI_TRIM PIECES

GRES PORCELLANATO A MASSA COLORATA_COLOURED-BODY PORCELAIN STONEWARE

BATTISCOPA 7,5x60 cm Rect - 3"x24" ± 10 mm NATURALE	GRADONE A COSTA RETTA 30x34 cm Rect - 12"x13.38" ± 9 mm NATURALE	ANGOLO GRADONE A COSTA RETTA 34x34 cm - 13.38"x13.38" ± 9 mm NATURALE	BATTISCOPA SCALA DX (kit 2 pezzi) 7,5x45 cm - 3"x18" ± 10 mm NATURALE	BATTISCOPA SCALA SX (kit 2 pezzi) 7,5x45 cm - 3"x18" ± 10 mm NATURALE	ELEMENTO "L" 15x30x4 cm Rect - 6"x12"x1.916" ± 9 mm STRUTTURATO*
PERCORSI	PGHR10	PGEHR10	PGEHR11	PGZHR1D	PGZHR1S
TRAGITTI	PGHR00	PGEHR00	PGEHR01	PGZHR0D	PGZHR0S
CAMMINI	PGHR30	PGEHR30	PGEHR31	PGZHR3D	PGZHR3S
PAESAGGI	PGHR20	PGEHR20	PGEHR21	PGZHR2D	PGZHR2S

ELEMENTO "L":

Realizzato tramite incollaggio_Made by gluing_Hergestellt durch Kleben_Réalisé par collage

Abbinabile alla finitura Strutturato_To be used with Strutturato version_Kombinierbar mit Finish Strutturato_Combinable à la finition Strutturato

GRES PORCELLANATO A MASSA COLORATA_COLOURED-BODY PORCELAIN STONEWARE **20 mm**

COSTA TORO ANGOLARE DX 30x90 cm Rect - 12"x36" STRUTTURATO*	COSTA TORO ANGOLARE SX 30x90 cm Rect - 12"x36" STRUTTURATO*	COSTA TORO 30x90 cm Rect - 12"x36" STRUTTURATO*	COSTA TORO GRIP 30x90 cm Rect - 12"x36" STRUTTURATO*	COSTA RETTA ANGOLARE DX 30x90 cm Rect - 12"x36" STRUTTURATO*	COSTA RETTA ANGOLARE SX 30x90 cm Rect - 12"x36" STRUTTURATO*
PERCORSI	PGFHRK2	PGFHRK3	PGFHRF1	PGFHRJ1	PGFHRD2
TRAGITTI	PGFHRK0	PGFHRK1	PGFHRF0	PGFHRJ0	PGFHRD0
CAMMINI	PGFHRK6	PGFHRK7	PGFHRF3	PGFHRJ3	PGFHRD6
PAESAGGI	PGFHRK4	PGFHRK5	PGFHRF2	PGFHRJ2	PGFHRD4
COSTA RETTA 30x90 cm Rect - 12"x36" STRUTTURATO*	COSTA RETTA GRIP 30x90 cm Rect - 12"x36" STRUTTURATO*	GRIGLIA ANGOLARE DX 15x45 cm Rect - 6"x18" STRUTTURATO*	GRIGLIA ANGOLARE SX 15x45 cm Rect - 6"x18" STRUTTURATO*	GRIGLIA 15x45 cm Rect - 6"x18" STRUTTURATO*	
PERCORSI	PGFHRK1	PGFHRG1	PGDHR2	PGDHR3	
TRAGITTI	PGFHRK0	PGFHRG0	PGDHR0	PGDHR1	
CAMMINI	PGFHRK3	PGFHRG3	PGDHR6	PGDHR7	
PAESAGGI	PGFHRK2	PGFHRG2	PGDHR4	PGDHR5	

* Protezione antibatterica non presente_No antimicrobial protection_Der Antibakterielle Schutz nicht vorhanden_Protection antibactérienne pas présente

IMBALLAGGI E PESI_PACKINGS AND WEIGHTS

DESCRIZIONE Description	± mm	FORMATI Sizes	SCATOLA_Box				PALLET		
FONDO NATURALE	9	120x120 ^{RECT}	1	31,8	1,44	-	28	890,4	40,32
FONDO NATURALE / STRUTTURATO	9	60x120 ^{RECT}	2	31,8	1,44	-	36	1144,8	51,84
FONDO NATURALE / STRUTTURATO	9	60x60 ^{RECT}	4	31,8	1,44	-	32	1017,6	46,08
FONDO STRUTTURATO	9	40x60 ^{RECT}	5	26,5	1,2	-	48	1272	57,6
FONDO NATURALE / STRUTTURATO	9	30x60 ^{RECT}	9	35	1,62	-	32	1120	51,84
INTARSI NATURALE	9	60x120 ^{RECT}	2	31,8	1,44	-	15	477	21,6
FOGLIA ORO - FOGLIA ARGENTO	9	60x120 ^{RECT}	1	15,9	0,72	-	30	477	21,6
MURETTO NATURALE	9	30x60 ^{RECT}	4	15	0,72	-	30	450	21,6
MOSAICO 16 PEZZI NATURALE	9	30x30 ^{RECT}	4	7,5	0,36	-	78	585	28,08
BATTISCOPA NATURALE	10	7,5x60 ^{RECT}	12	11,61	0,54	7,2	60	696,6	32,4
BATTISCOPA SCALA (KIT 2 PZ.) NATURALE	10	7,5x45	5	7,5	0,337	-	-	-	-
GRADONE A COSTA RETTA NATURALE	9	30x34 ^{RECT}	6	16,625	0,612	-	30	498,75	18,36
ANGOLO GRADONE A COSTA RETTA NATURALE	9	34x34	2	6,27	0,231	-	48	300,96	11,097
ELEMENTO "L" STRUTTURATO	9	15x30x4 ^{RECT}	8	8,74	0,36	2,4	48	419,52	17,28
FONDO STRUTTURATO	20	60x90 ^{RECT}	1	25	0,54	-	40	1000	21,6
COSTA TORO STRUTTURATO	20	30x90 ^{RECT}	1	12,2	0,27	-	32	390,4	8,64
COSTA TORO ANGOLARE STRUTTURATO	20	30x90 ^{RECT}	1	10,2	0,225	-	32	326,4	7,2
COSTA TORO GRIP STRUTTURATO	20	30x90 ^{RECT}	1	12,2	0,27	-	32	390,4	8,64
COSTA RETTA STRUTTURATO	20	30x90 ^{RECT}	1	12,2	0,27	-	32	390,4	8,64
COSTA RETTA ANGOLARE STRUTTURATO	20	30x90 ^{RECT}	1	10,2	0,225	-	32	326,4	7,2
COSTA RETTA GRIP STRUTTURATO	20	30x90 ^{RECT}	1	12,2	0,27	-	32	390,4	8,64
GRIGLIA STRUTTURATO	20	15x45 ^{RECT}	4	11,2	0,27	-	48	537,6	12,96
GRIGLIA ANGOLARE STRUTTURATO	20	15x45 ^{RECT}	4	10	0,225	-	48	480	10,8



Effetto cemento



Concrete look_Zement-Optik_Effet ciment



Context



SQUARE



LOFT



STORE

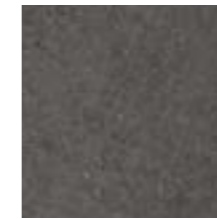

HANGAR

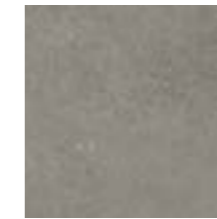

MANSION

GRES PORCELLANATO A MASSA COLORATA_COLOURED-BODY PORCELAIN STONEWARE



± 9,5 mm



90x90 cm Rect
36"x36"



60x120 cm Rect
24"x48"



60x60 cm Rect
24"x24"



30x60 cm Rect
12"x24"

GRES PORCELLANATO A MASSA COLORATA_COLOURED-BODY PORCELAIN STONEWARE **20 mm**



± 20 mm



60x120 cm Rect
24"x48"



PAVIMENTO / FLOOR
COUNTERTOP Mansion Naturale 90x90 cm Rect - 36"x36"
Mansion Naturale



PAVIMENTO / FLOOR Square Strutturato 60x60 cm Rect - 24"x24" _Square Strutturato 60x120 cm Rect - 24"x48" 20 mm



PAVIMENTO / FLOOR Hangar Naturale 60x60 cm Rect - 24"x24"



PAVIMENTO / FLOOR Venice Loft Naturale 60x60 cm Recxt - 24"x24"



PAVIMENTO / FLOOR Quarter Store Naturale 60x60 cm Rect - 24"x24"



RIVESTIMENTO / WALL Store Naturale 60x120 cm Rect - 24"x48"
PAVIMENTO / FLOOR Store Naturale 90x90 cm Rect - 36"x36"

Context

P R () T E C T
ANTIBATTERICO - ANTIMICROBIAL

SQUARE



LOFT



STORE



HANGAR



MANSION



Context

GRES PORCELLANATO A MASSA COLORATA_COLOURED-BODY PORCELAIN STONEWARE



90x90 cm Rect - 36"x36"

Square NATURALE PGGXT30G
Loft NATURALE PGGXT10G
Store NATURALE PGGXT40G
Hangar NATURALE PGGXT00G
Mansion NATURALE PGGXT20G



60x120 cm Rect - 24"x48"

Square NATURALE PGXXT30
Loft NATURALE PGXXT10
Store NATURALE PGXXT40
Hangar NATURALE PGXXT00
Mansion NATURALE PGXXT20



60x60 cm Rect - 24"x24"

Square NATURALE PGWXT30
Loft NATURALE PGWXT10
Store NATURALE PGWXT40
Hangar NATURALE PGWXT00
Mansion NATURALE PGWXT20
Square STRUTTURATO* PGWXT35
Loft STRUTTURATO* PGWXT15
Store STRUTTURATO* PGWXT45
Hangar STRUTTURATO* PGWXT05
Mansion STRUTTURATO* PGWXT25



30x60 cm Rect - 12"x24"

Square NATURALE PG-XT30
Loft NATURALE PG-XT10
Store NATURALE PG-XT40
Hangar NATURALE PG-XT00
Mansion NATURALE PG-XT20
Square STRUTTURATO* PG-XT35
Loft STRUTTURATO* PG-XT15
Store STRUTTURATO* PG-XT45
Hangar STRUTTURATO* PG-XT05
Mansion STRUTTURATO* PG-XT25

GRES PORCELLANATO A MASSA COLORATA_COLOURED-BODY PORCELAIN STONEWARE **20 mm**

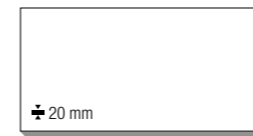

60x120 cm Rect - 24"x48"

Square STRUTTURATO* PGXXT631
Loft STRUTTURATO* PGXXT611
Store STRUTTURATO* PGXXT641
Hangar STRUTTURATO* PGXXT601
Mansion STRUTTURATO* PGXXT621

DESTINAZIONI D'USO_INTENDED USE: NATURALE STRUTTURATO

DATI TECNICI_TECHNICAL DATA:

GRES PORCELLANATO A MASSA COLORATA COLOURED-BODY PORCELAIN STONEWARE		GRES PORCELLANATO A MASSA COLORATA COLOURED-BODY PORCELAIN STONEWARE	
+	9,5 mm		20 mm
DIN EN 16165 - Annex B:	R10 Naturale R11 Strutturato	DIN EN 16165 - Annex B:	R11 Strutturato
DIN EN 16165 - Annex A:	B (A+B) Naturale C (A+B+C) Strutturato	DIN EN 16165 - Annex A:	C (A+B+C) Strutturato
BCR TORTUS: ANSI A326.3:	μ > 0,40 Naturale - Strutturato ID - DCOF ≥ 0,42 (dry) Naturale IW - DCOF ≥ 0,42 (wet) Naturale IW+ Naturale* EW Strutturato	BCR TORTUS: ANSI A326.3:	μ > 0,40 Strutturato EW Strutturato
AS/NZS 4586:	P3 Naturale P4 Strutturato	AS/NZS 4586:	P4 Strutturato
BS 7976-2:	PTV 36+WET (SI.96) Naturale PTV 36+WET (SI.96 - SI.55) Strutturato	BS 7976-2:	PTV 36+WET (SI.96 - SI.55) Strutturato
	ANSI A137.1: V2 Naturale - Strutturato		ANSI A137.1: V2 Strutturato
P R () T E C T ANTIBATTERICO - ANTIMICROBIAL	Naturale		

* Ad eccezione delle zone caratterizzate da un maggior rischio di scivolamento (come docce pubbliche, piscine coperte, ecc.) per le quali si consiglia una superficie Strutturato
With the exception of areas characterized by a higher risk of slipping (such as public showers, indoor swimming pools, etc.) for which a Strutturato surface is recommended

* Protezione antibatterica non presente_No antimicrobial protection_Der Antibakterielle Schutz nicht vorhanden_Protection antibactérienne pas présente

Context

DECORI_DECORS

GRES PORCELLANATO A MASSA COLORATA_COLOURED-BODY PORCELAIN STONEWARE

SQUARE



QUARTER NATURALE
60x60 cm Rect - 24"x24"
± 9,5 mm
PGWXTQ3



VENICE NATURALE
60x60 cm Rect - 24"x24"
± 9,5 mm
PGWXT53



MURETTO 3D NATURALE
30x60 cm Rect - 12"x24"
± 9,5 mm
PG-XTM3



MOSAICO 36 PEZZI NATURALE
30x30 cm Rect - 12"x12"
± 9,5 mm
PGZXTM3

HANGAR

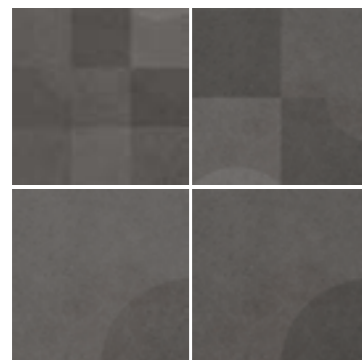

QUARTER NATURALE
60x60 cm Rect - 24"x24"
± 9,5 mm
PGWXTQ0



MURETTO 3D NATURALE
30x60 cm Rect - 12"x24"
± 9,5 mm
PG-XTM0



MOSAICO 36 PEZZI NATURALE
30x30 cm Rect - 12"x12"
± 9,5 mm
PGZXTM0

LOFT

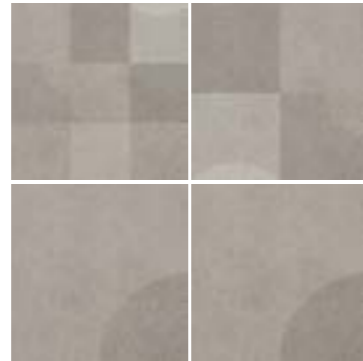

QUARTER NATURALE
60x60 cm Rect - 24"x24"
± 9,5 mm
PGWXTQ1



VENICE NATURALE
60x60 cm Rect - 24"x24"
± 9,5 mm
PGWXT51



MURETTO 3D NATURALE
30x60 cm Rect - 12"x24"
± 9,5 mm
PG-XTM1



MOSAICO 36 PEZZI NATURALE
30x30 cm Rect - 12"x12"
± 9,5 mm
PGZXTM1

MANSION

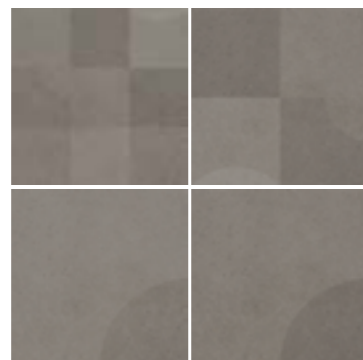

QUARTER NATURALE
60x60 cm Rect - 24"x24"
± 9,5 mm
PGWXTQ2



MURETTO 3D NATURALE
30x60 cm Rect - 12"x24"
± 9,5 mm
PG-XTM2



MOSAICO 36 PEZZI NATURALE
30x30 cm Rect - 12"x12"
± 9,5 mm
PGZXTM2

STORE

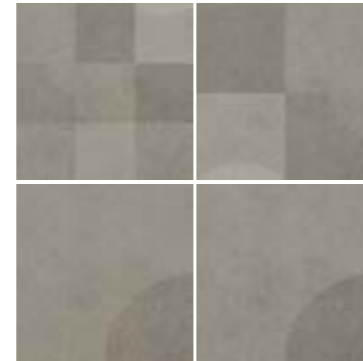

QUARTER NATURALE
60x60 cm Rect - 24"x24"
± 9,5 mm
PGWXTQ4



VENICE NATURALE
60x60 cm Rect - 24"x24"
± 9,5 mm
PGWXT54



MURETTO 3D NATURALE
30x60 cm Rect - 12"x24"
± 9,5 mm
PG-XTM4



MOSAICO 36 PEZZI NATURALE
30x30 cm Rect - 12"x12"
± 9,5 mm
PGZXTM4

QUARTER:

Composizione 4 pezzi_4 pieces composition_
4 Stück- Komposition_Composition 4 pièces

MURETTO 3D:

Posare solo a parete_Recommended only for wall
applications_Nur an der Wand verlegen_Recommended
seulement pour les revêtements

Context

PEZZI SPECIALI_TRIM PIECES

GRES PORCELLANATO A MASSA COLORATA_COLOURED-BODY PORCELAIN STONEWARE

	BATTISCOPA 10x60 cm Rect - 4"x24" ± 10 mm NATURALE	ANGOLO GRADONE A COSTA RETTA 34x34 cm - 13 ^{3/8} "x13 ^{3/8} " ± 9,5 mm NATURALE	GRADONE A COSTA RETTA 30x34 cm Rect - 12"x13 ^{3/8} " ± 9,5 mm NATURALE	BATTISCOPA SCALA DX (kit 2 pezzi) 10x45 cm - 4"x18" ± 10 mm NATURALE	BATTISCOPA SCALA SX (kit 2 pezzi) 10x45 cm - 4"x18" ± 10 mm NATURALE	ELEMENTO "L" 15x30x4 cm - 6"x12"x1 ^{9/16} " ± 9 mm STRUTTURATO*
SQUARE	PGRXT30	PGEXT31	PGEXT30	PGZXT3D	PGZXT3S	PGZXTA3
LOFT	PGRXT10	PGEXT11	PGEXT10	PGZXT1D	PGZXT1S	PGZXTA1
STORE	PGRXT40	PGEXT41	PGEXT40	PGZXT4D	PGZXT4S	PGZXTA4
HANGAR	PGRXT00	PGEXT01	PGEXT00	PGZXT0D	PGZXT0S	PGZXTA0
MANSION	PGRXT20	PGEXT21	PGEXT20	PGZXT2D	PGZXT2S	PGZXTA2

GRES PORCELLANATO A MASSA COLORATA_COLOURED-BODY PORCELAIN STONEWARE **20 mm**

	COSTA TORO ANGOLORE DX 30x60 cm Rect - 12"x24" STRUTTURATO*	COSTA TORO ANGOLORE SX 30x60 cm Rect - 12"x24" STRUTTURATO*	COSTA TORO 30x60 cm Rect - 12"x24" STRUTTURATO*	COSTA TORO GRIP 30x60 cm Rect - 12"x24" STRUTTURATO*	COSTA RETTA ANGOLORE DX 30x60 cm Rect - 12"x24" STRUTTURATO*	COSTA RETTA ANGOLORE SX 30x60 cm Rect - 12"x24" STRUTTURATO*
SQUARE	PGDXTK3	PGDXTK7	PGDXTF3	PGDXTJ3	PGDXTD3	PGDXTD7
LOFT	PGDXTK1	PGDXTK9	PGDXTF1	PGDXTJ1	PGDXTD1	PGDXTD9
STORE	PGDXTK4	PGDXTK8	PGDXTF4	PGDXTJ4	PGDXTD4	PGDXTD8
HANGAR	PGDXTK0	PGDXTK5	PGDXTF0	PGDXTJ0	PGDXTD0	PGDXTD6
MANSION	PGDXTK2	PGDXTK6	PGDXTF2	PGDXTJ2	PGDXTD2	PGDXTD5

	COSTA RETTA 30x60 cm Rect - 12"x24" STRUTTURATO*	COSTA RETTA GRIP 30x60 cm Rect - 12"x24" STRUTTURATO*	GRIGLIA ANGOLORE DX 15x60 cm Rect - 6"x24" STRUTTURATO*	GRIGLIA ANGOLORE SX 15x60 cm Rect - 6"x24" STRUTTURATO*	GRIGLIA 15x60 cm Rect - 6"x24" STRUTTURATO*
SQUARE	PGDXTC3	PGDXTG3	PG1XTA3	PG1XTA7	PG1XTZ3
LOFT	PGDXTC1	PGDXTG1	PG1XTA1	PG1XTA9	PG1XTZ1
STORE	PGDXTC4	PGDXTG4	PG1XTA4	PG1XTA8	PG1XTZ4
HANGAR	PGDXTC0	PGDXTG0	PG1XTA0	PG1XTA5	PG1XTZ0
MANSION	PGDXTC2	PGDXTG2	PG1XTA2	PG1XTA6	PG1XTZ2

* Protezione antibatterica non presente_No antimicrobial protection_Der Antibakterielle Schutz nicht vorhanden_Protection antibactérienne pas présente

IMBALLAGGI E PESI_PACKINGS AND WEIGHTS

DESCRIZIONE Description	± mm	FORMATI Sizes	SCATOLA_Box				PALLET			
FONDO NATURALE	9,5	60x120 ^{RECT}	2	31,8	1,44	-	36	1144,8	51,84	
FONDO NATURALE	9,5	90x90 ^{RECT}	2	33,6	1,62	-	25	840	40,5	
FONDO NATURALE / STRUTTURATO	9,5	60x60 ^{RECT}	4	31,8	1,44	-	32	1017,6	46,08	
FONDO NATURALE / STRUTTURATO	9,5	30x60 ^{RECT}	8	31,8	1,44	-	32	1017,6	46,08	
MOSAICO 36 PEZZI NATURALE	9,5	30x30 ^{RECT}	4	7,31	0,36	-	78	570,57	28,08	
MURETTO 3D NATURALE	9,5	30x60 ^{RECT}	4	15,7	0,72	-	18	282,6	12,96	
VENICE NATURALE	9,5	60x60 ^{RECT}	4	31,8	1,44	-	32	1017,6	46,08	
QUARTER NATURALE	9,5	60x60 ^{RECT}	4	31,8	1,44	-	26	826,8	37,44	
BATTISCOPA NATURALE	10	10x60 ^{RECT}	12	15	0,72	7,2	60	900	43,2	
BATTISCOPA SCALA (KIT 2 PZ.) NATURALE	10	10x45	5	8,5	0,425	-	-	-	-	
GRADONE A COSTA RETTA NATURALE	9,5	30x34 ^{RECT}	6	17,1	0,612	-	30	513	18,36	
ANGOLO GRADONE A COSTA RETTA NATURALE	9,5	34x34	2	6,27	0,231	-	48	300,96	11,09	
ELEMENTO "L" STRUTTURATO	9	15x30xh4	8	9,6	0,36	2,4	48	460,8	17,28	
FONDO STRUTTURATO	20	60x120 ^{RECT}	1	32,5	0,72	-	36	1170	25,92	
COSTA TORO STRUTTURATO	20	30x60 ^{RECT}	1	8,125	0,18	-	100	812,5	18	
COSTA TORO ANGOLORE STRUTTURATO	20	30x60 ^{RECT}	1	6,1	0,135	-	100	610	13,5	
COSTA TORO GRIP STRUTTURATO	20	30x60 ^{RECT}	1	8,125	0,18	-	100	812,5	18	
COSTA RETTA STRUTTURATO	20	30x60 ^{RECT}	1	8,125	0,18	-	100	812,5	18	
COSTA RETTA ANGOLORE STRUTTURATO	20	30x60 ^{RECT}	1	6,1	0,135	-	100	610	13,5	
COSTA RETTA GRIP STRUTTURATO	20	30x60 ^{RECT}	1	8,125	0,18	-	100	812,5	18	
GRIGLIA STRUTTURATO	20	15x60 ^{RECT}	2	8	0,18	-	100	800	18	
GRIGLIA ANGOLORE STRUTTURATO	20	15x60 ^{RECT}	2	7	0,157	-	100	700	15,75	



Experience



BIANCO DENSO



BEIGE TENUE



GRIGIO VIVO

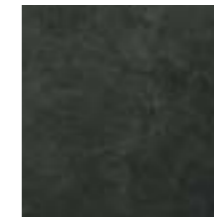

NERO PURO

GRES PORCELLANATO LAMINATO_LAMINATED PORCELAIN STONEWARE **Zero.3**



± 3,5 mm



100x300 cm Rect
39"x118"

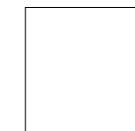

100x100 cm Rect
39"x39"



50x100 cm Rect
19 1/2"x39"



50x50 cm Rect
19 1/2"x19 1/2"



RIVESTIMENTO / WALL **Beige Tenue Naturale 100x300 cm Rect - 39"x118"**
 PAVIMENTO / FLOOR **Beige Tenue Naturale 100x300 cm Rect - 39"x118"**



RIVESTIMENTO / WALL **Bianco Denso Naturale 100x300 cm Rect - 39"x118"**
 PAVIMENTO / FLOOR **Grigio Vivo Naturale 100x100 cm Rect - 39"x39"**

Experience

P R () T E C T
ANTIBATTERICO - ANTIMICROBIAL

BIANCO DENSO



BEIGE TENUE



GRIGIO VIVO



NERO PURO

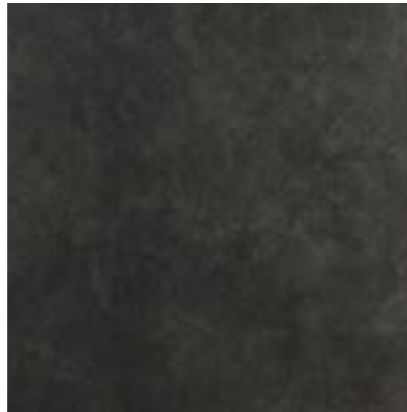

Experience

GRES PORCELLANATO LAMINATO_LAMINATED PORCELAIN STONEWARE Zero.3

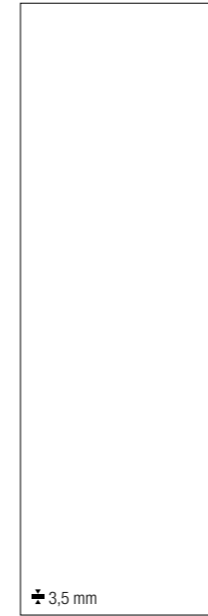

100x300 cm Rect - 39"x118"

Bianco Denso NATURALE PG7EX055
Beige Tenue NATURALE PG7EX155
Grigio Vivo NATURALE PG7EX255
Nero Puro NATURALE PG7EX355



100x100 cm Rect - 39"x39"

Bianco Denso NATURALE PG8EX05
Beige Tenue NATURALE PG8EX15
Grigio Vivo NATURALE PG8EX25
Nero Puro NATURALE PG8EX35

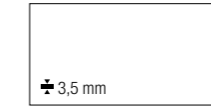



50x100 cm Rect - 19^{1/2}"x39"

Bianco Denso NATURALE PG9EX05
Beige Tenue NATURALE PG9EX15
Grigio Vivo NATURALE PG9EX25
Nero Puro NATURALE PG9EX35



50x50 cm Rect - 19^{1/2}"x19^{1/2}"



Bianco Denso NATURALE PGVEX05
Beige Tenue NATURALE PGVEX15
Grigio Vivo NATURALE PGVEX25
Nero Puro NATURALE PGVEX35

DESTINAZIONI D'USO_INTENDED USE: NATURALE  

DATI TECNICI_TECHNICAL DATA:

GRES PORCELLANATO LAMINATO
LAMINATED PORCELAIN STONEWARE

 3,5 mm

 DIN EN 16165 - Annex B: R9 Naturale
 ANSI A326.3: ID - DCOF \geq 0.42 (dry) Naturale

 ANSI A137.3: V2 Naturale

P R () T E C T
ANTIBATTERICO - ANTIMICROBIAL Naturale

Experience

DECORI_DECORS

GRES PORCELLANATO LAMINATO_LAMINATED PORCELAIN STONEWARE **Zero.3**

FLORA



FLORA A
100x100 cm Rect - 39"x39"
± 3,5 mm
PG8EXFA

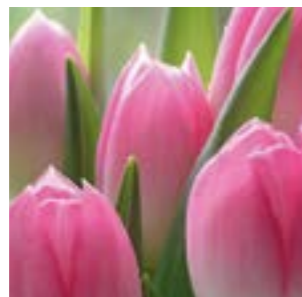

FLORA B
100x100 cm Rect - 39"x39"
± 3,5 mm
PG8EXFB



FLORA C
100x100 cm Rect - 39"x39"
± 3,5 mm
PG8EXFC



FLORA E
100x100 cm Rect - 39"x39"
± 3,5 mm
PG8EXFE



FLORA D
100x100 cm Rect - 39"x39"
± 3,5 mm
PG8EXFD

FLORA:

Rivestimenti decorati da interno_Interior decorated wall coverings_Dekorierete Wandbelege für Innenbereich_Décors pour revêtement mural intérieur

I decori Flora sono realizzati mediante la tecnologia di stampa digitale a freddo, che permette di raggiungere risultati estetici e cromatici di eccezionale qualità. Le grafiche vengono impresse ad altissima risoluzione sul supporto ceramico, mantenendo invariati i colori brillanti e le sfumature dei motivi decorativi. Flora decors are made using digital cold printing technology, with which aesthetic, chromatic results of exceptional quality are achieved. The graphics are printed at very high resolution on the ceramic substrate, keeping the brilliant colors and shades of the decorative designs unaltered. Die Flora-Dekore werden mit der kalten Digitaldrucktechnologie hergestellt, die es ermöglicht, ästhetische und chromatische Ergebnisse von außergewöhnlicher Qualität zu erzielen. Die Grafiken werden in sehr hoher Auflösung auf den Keramikträger gedruckt, wobei die brillanten Farben und Schattierungen der dekorativen Motive unverändert bleiben. Les décors Flora sont réalisés grâce à la technologie d'impression numérique à froid, qui permet d'obtenir des résultats esthétiques et chromatiques d'une qualité exceptionnelle. Les graphismes sont imprimés en haute résolution sur le support céramique, en préservant la brillance des couleurs et les nuances des motifs décoratifs.

Le dimensioni dei decori sono personalizzabili_Decors dimensions can be customized_Das Format der Dekoren ist auf Wunsch realisierbar_La dimension des décors peut être personnalisée

Protezione antibatterica non presente_No antimicrobial protection_Der Antibakterielle Schutz nicht vorhanden_Protection antibactérienne pas présente

Attenzione: per la pulizia dei decori attenersi scrupolosamente alle istruzioni riportate a pagina 415_Notice: for decors cleaning you should follow carefully the instructions provided on page 415_Achtung: für die Reinigung sich genau auf die Anleitungen auf der Seite 415 halten_Attention: pour le nettoyage des décors il faut suivre scrupuleusement les renseignements contenus à page 415

IMBALLAGGI E PESI_PACKINGS AND WEIGHTS

DESCRIZIONE Description	± mm	FORMATI Sizes	SCATOLA_Box				PALLET		
FONDO NATURALE	3,5	100x300 ^{RECT}	1	23,4	3	-	20	468	60
FONDO NATURALE	3,5	100x100 ^{RECT}	3	23,4	3	-	25	585	75
FONDO NATURALE	3,5	50x100 ^{RECT}	5	19,5	2,5	-	32	624	80
FONDO NATURALE	3,5	50x50 ^{RECT}	7	13,65	1,75	-	48	655,2	84
FLORA	3,5	100x100 ^{RECT}	1	7,8	1	-	-	-	-



RIVESTIMENTO / WALL PAVIMENTO / FLOOR Nero Puro Naturale 100x300 cm Rect - 39"x118" _Flora C 100x100 cm Rect - 39"x39" Beige Tenue Naturale 100x300 cm Rect - 39"x118"



Memory Mood



CREAMY



HAZEL



COPPER



SHEER



DIM



KEEN

GRES PORCELLANATO A MASSA COLORATA_COLOURED-BODY PORCELAIN STONEWARE



± 9 mm
± 9,5 mm



60x60 cm Rect
24"x24"
60,3x60,3 cm
24"x24"



20x20 cm
8"x8"



PAVIMENTO / FLOOR Dim Naturale 60,3x60,3 cm - 24"x24"



PAVIMENTO / FLOOR Hazel Naturale 60,3x60,3 cm - 24"x24"



PAVIMENTO / FLOOR Keen Naturale 60,3x60,3 cm - 24"x24"



RIVESTIMENTO / WALL Assi d'Alpe Stube Naturale 20x90,5 cm - 8"x36"
PAVIMENTO / FLOOR Sheer Naturale 20x20 cm - 8"x8" _Decor Mood 1 Naturale 20x20 cm - 8"x8"



RIVESTIMENTO / WALL Decor Mood Mix Naturale 20x20 cm - 8"x8"

Memory Mood

CREAMY



HAZEL



COPPER



SHEER



DIM



KEEN



GRES PORCELLANATO A MASSA COLORATA_COLOURED-BODY PORCELAIN STONWARE



60x60 cm Rect - 24"x24"

Creamy NATURALE PGWMER1
Hazel NATURALE PGWMER3
Copper NATURALE PGWMER0
Sheer NATURALE PGWMER5
Dim NATURALE PGWMER2
Keen NATURALE PGWMER4



60,3x60,3 cm - 24"x24"

Creamy NATURALE PGWME10
Hazel NATURALE PGWME30
Copper NATURALE PGWME00
Sheer NATURALE PGWME50
Dim NATURALE PGWME20
Keen NATURALE PGWME40

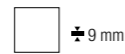

20x20 cm - 8"x8"

Creamy NATURALE PGEME10
Hazel NATURALE PGEME30
Copper NATURALE PGEME00
Sheer NATURALE PGEME50
Dim NATURALE PGEME20
Keen NATURALE PGEME40

DESTINAZIONI D'USO_INTENDED USE: NATURALE

DATI TECNICI_TECHNICAL DATA:

GRES PORCELLANATO A MASSA COLORATA COLOURED-BODY PORCELAIN STONWARE	
+	9 / 9,5 mm
	DIN EN 16165 - Annex B: R10 Naturale DIN EN 16165 - Annex A: B (A+B) Naturale
	BCR TORTUS: $\mu > 0,40$ Naturale
	ANSI A326.3: ID - DCOF $\geq 0,42$ (dry) Naturale IW - DCOF $\geq 0,42$ (wet) Naturale
	UNE 41901 EX: Classe 2 Naturale
	ANSI A137.1: V3 Naturale

Memory Mood

DECORI_DECORS

GRES PORCELLANATO A MASSA COLORATA_COLOURED-BODY PORCELAIN STONWARE

COMPOSIZIONE DI 9 PEZZI_9 PIECES COMPOSITION

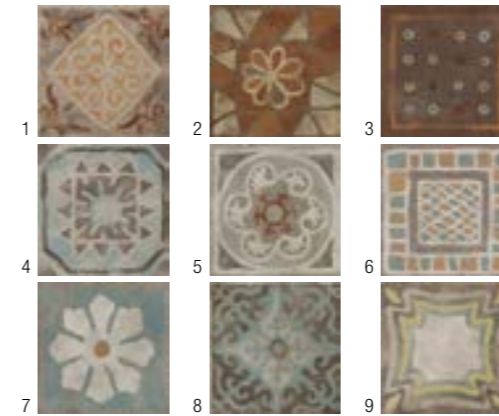

DECOR MOOD
20x20 cm - 8"x8"
± 9 mm

Decor Mood 1	PGEMED1	Decor Mood 6	PGEMED6
Decor Mood 2	PGEMED2	Decor Mood 7	PGEMED7
Decor Mood 3	PGEMED3	Decor Mood 8	PGEMED8
Decor Mood 4	PGEMED4	Decor Mood 9	PGEMED9
Decor Mood 5	PGEMED5		



DECOR MOOD MIX
20x20 cm - 8"x8"
± 9 mm

PGEMEDM

PEZZI SPECIALI_TRIM PIECES

GRES PORCELLANATO A MASSA COLORATA_COLOURED-BODY PORCELAIN STONWARE



BATTISCOPA
10x60 cm Rect - 4"x24"
± 10 mm

NATURALE

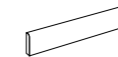

BATTISCOPA
10x60,3 cm - 4"x24"
± 10 mm

NATURALE



ANGOLO GRADONE A COSTA RETTA
34x34 cm - 13^{3/8}"x13^{3/8}"
± 9,5 mm

NATURALE



GRADONE A COSTA RETTA
30x34 cm Rect - 12"x13^{3/8}"
± 9,5 mm

NATURALE

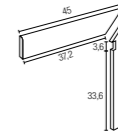

BATTISCOPA SCALA DX (kit 2 pezzi)
10x45 cm - 4"x18"
± 10 mm

NATURALE

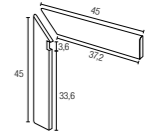

BATTISCOPA SCALA SX (kit 2 pezzi)
10x45 cm - 4"x18"
± 10 mm

NATURALE

	CREAMY	HAZEL	COPPER	SHEER	DIM	KEEN
BATTISCOPA	PGRME11	PGRME31	PGRME01	PGRME51	PGRME21	PGRME41
BATTISCOPA	PGRME10	PGRME30	PGRME00	PGRME50	PGRME20	PGRME40
ANGOLO GRADONE A COSTA RETTA	PGEME11	PGEME31	PGEME01	PGEME51	PGEME21	PGEME41
GRADONE A COSTA RETTA	PGEME10	PGEME30	PGEME00	PGEME50	PGEME20	PGEME40
BATTISCOPA SCALA DX (kit 2 pezzi)	PGZME1D	PGZME3D	PGZME0D	PGZME5D	PGZME2D	PGZME4D
BATTISCOPA SCALA SX (kit 2 pezzi)	PGZME1S	PGZME3S	PGZME0S	PGZME5S	PGZME2S	PGZME4S

IMBALLAGGI E PESI_PACKINGS AND WEIGHTS

DESCRIZIONE Description	± mm	FORMATI Sizes	SCATOLA_Box			PALLET			
FONDO NATURALE	9,5	60x60 ^{RECT}	4	31	1,44	-	32	992	46,08
FONDO NATURALE	9,5	60,3x60,3	4	31,8	1,45	-	32	1018	46,5
FONDO NATURALE	9	20x20	30	25	1,2	-	45	1125	54
DECOR MOOD NATURALE	9	20x20	30	25	1,2	-	45	1125	54
DECOR MOOD MIX NATURALE	9	20x20	9	6,9	0,36	-	30	207	10,8
BATTISCOPA NATURALE	10	10x60 ^{RECT}	12	15,48	0,72	7,2	60	929	43,2
BATTISCOPA NATURALE	10	10x60,3	16	20	0,9648	9,648	48	960	46,31
BATTISCOPA SCALA (KIT 2 PZ.) NATURALE	10	10x45	5	8,5	0,4	-	-	-	-
GRADONE A COSTA RETTA NATURALE	9,5	30x34 ^{RECT}	6	17,5	0,61	-	30	524	18,4
ANGOLO GRADONE A COSTA RETTA NATURALE	9,5	34x34	2	6,3	0,23	-	48	301	11,1

Urbanature



LIME



CONCRETE



CEMENT



PORTLAND



SILICON

GRES PORCELLANATO LAMINATO_LAMINATED PORCELAIN STONEWARE **Zero.3**



± 3,5 mm

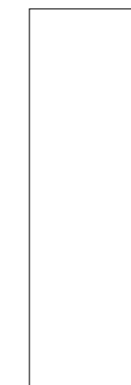

100x300 cm Rect
39"x118"

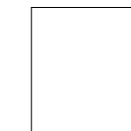

100x100 cm Rect
39"x39"



50x100 cm Rect
19^{1/2}"x39"

GRES PORCELLANATO A MASSA COLORATA_COLOURED-BODY PORCELAIN STONEWARE



± 9,5 mm



90x90 cm Rect
36"x36"



45x90 cm Rect
18"x36"



22,5x90 cm Rect
9"x36"



60x60 cm Rect
24"x24"



30x60 cm Rect
12"x24"

GRES PORCELLANATO A MASSA COLORATA_COLOURED-BODY PORCELAIN STONEWARE **20 mm**



± 20 mm



60x60 cm Rect
24"x24"



RIVESTIMENTO / WALL Lime Naturale 100x300 cm Rect - 39"x118" _100x100 cm Rect - 39"x39" _50x100 cm Rect - 19 1/2"x39"
 PAVIMENTO / FLOOR Silicon Naturale 100x100 cm Rect - 39"x39"



RIVESTIMENTO / WALL Lime Naturale 100x300 cm Rect - 39"x118" _50x100 cm Rect - 19 1/2"x39"
 PAVIMENTO / FLOOR Silicon Naturale 100x100 cm Rect - 39"x39"



RIVESTIMENTO / WALL Cement Naturale 100x300 cm Rect - 39"x118" Urban Leaves 2 50x100 cm Rect - 19 1/2"x39"
PAVIMENTO / FLOOR Cement Naturale 100x100 cm Rect - 39"x39"



RIVESTIMENTO / WALL Urban Steel Portland Naturale 60x60 cm Rect - 24"x24"
PAVIMENTO / FLOOR Portland Naturale 60x60 cm Rect - 24"x24"



RIVESTIMENTO / WALL Portland Naturale 30x60 cm Rect - 12"x24"_Urban Texture Portland 30x60 cm Rect - 12"x24"



RIVESTIMENTO / WALL Silicon Naturale 100x300 cm Rect - 39"x118" 50x100 cm Rect - 19 1/2"x39" Urban Tweed 2 50x100 cm Rect - 19 1/2"x39"
PAVIMENTO / FLOOR Silicon Naturale 100x100 cm Rect - 39"x39"

LIME



CONCRETE



CEMENT



PORTLAND



SILICON



GRES PORCELLANATO LAMINATO_LAMINATED PORCELAIN STONEWARE **Zero.3**



100x300 cm Rect - 39"x118"
Lime NATURALE PZ7UN00
Concrete NATURALE PZ7UN10
Cement NATURALE PZ7UN20
Portland NATURALE PZ7UN30
Silicon NATURALE PZ7UN40



100x100 cm Rect - 39"x39"
Lime NATURALE PZ8UN00
Concrete NATURALE PZ8UN10
Cement NATURALE PZ8UN20
Portland NATURALE PZ8UN30
Silicon NATURALE PZ8UN40

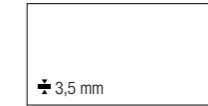

50x100 cm Rect - 19 1/2"x39"
Lime NATURALE PZ9UN00
Concrete NATURALE PZ9UN10
Cement NATURALE PZ9UN20
Portland NATURALE PZ9UN30
Silicon NATURALE PZ9UN40

GRES PORCELLANATO A MASSA COLORATA_COLOURED-BODY PORCELAIN STONEWARE



90x90 cm Rect - 36"x36"
Lime NATURALE PGGUNR0G
Concrete NATURALE PGGUNR1G
Cement NATURALE PGGUNR2G
Portland NATURALE PGGUNR3G
Silicon NATURALE PGGUNR4G
Portland EXT* PGGUNG3G

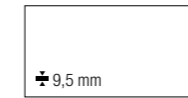

45x90 cm Rect - 18"x36"
Lime NATURALE PGHUN00G
Concrete NATURALE PGHUN10G
Cement NATURALE PGHUN20G
Portland NATURALE PGHUN30G
Silicon NATURALE PGHUN40G

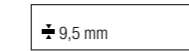

22,5x90 cm Rect - 9"x36"
Lime NATURALE PG2UN00G
Concrete NATURALE PG2UN10G
Cement NATURALE PG2UN20G
Portland NATURALE PG2UN30G
Silicon NATURALE PG2UN40G

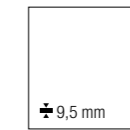

60x60 cm Rect - 24"x24"
Lime NATURALE PGWUN01P
Concrete NATURALE PGWUN11P
Cement NATURALE PGWUN21P
Portland NATURALE PGWUN31P
Silicon NATURALE PGWUN41P



30x60 cm Rect - 12"x24"
Lime NATURALE PG-UN01
Concrete NATURALE PG-UN11
Cement NATURALE PG-UN21
Portland NATURALE PG-UN31
Silicon NATURALE PG-UN41

DESTINAZIONI D'USO_INTENDED USE: NATURALE *esclusa Zero.3_except Zero.3 STRUTTURATO / EXT

DATI TECNICI_TECHNICAL DATA:

GRES PORCELLANATO LAMINATO LAMINATED PORCELAIN STONEWARE	GRES PORCELLANATO A MASSA COLORATA COLOURED-BODY PORCELAIN STONEWARE	GRES PORCELLANATO A MASSA COLORATA COLOURED-BODY PORCELAIN STONEWARE
3,5 mm	9,5 mm	20 mm
DIN EN 16165 - Annex B: R9 Naturale BCR TORTUS: $\mu > 0,40$ Naturale ANSI A326.3: ID - DCOF $\geq 0,42$ (dry) Naturale	DIN EN 16165 - Annex B: R9 Naturale R11 Ext C (A+B+C) Ext DIN EN 16165 - Annex A: $\mu > 0,40$ Naturale - Ext BCR TORTUS: ID - DCOF $\geq 0,42$ (dry) Naturale ANSI A326.3: ID - DCOF $\geq 0,42$ (dry) Naturale EW Ext AS/NZS 4586: P4 Ext BS 7976-2: PTV 36+WET (SI.96 - SI.55) Ext	DIN EN 16165 - Annex B: R11 Strutturato DIN EN 16165 - Annex A: C (A+B+C) Strutturato BCR TORTUS: $\mu > 0,40$ Strutturato ANSI A326.3: EW Strutturato AS/NZS 4586: P4 Strutturato BS 7976-2: PTV 36+WET (SI.96 - SI.55) Strutturato
ANSI A137.3: V2 Naturale	ANSI A137.1: V2 Naturale - Ext	ANSI A137.1: V2 Strutturato
PR()TECT ANTIBATTERICO - ANTIMICROBIAL Naturale	PR()TECT ANTIBATTERICO - ANTIMICROBIAL Naturale	

GRES PORCELLANATO A MASSA COLORATA_COLOURED-BODY PORCELAIN STONEWARE **20 mm**











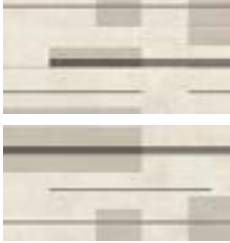

60x60 cm Rect - 24"x24"
Cement STRUTTURATO* PGWUN29
Portland STRUTTURATO* PGWUN39

* Protezione antibatterica non presente_No antimicrobial protection_Der Antibakterielle Schutz nicht vorhanden_Protection antibactérienne pas présente

Urbanature

DECORI_DECORS

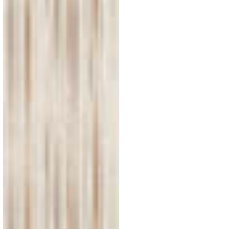
GRES PORCELLANATO LAMINATO_LAMINATED PORCELAIN STONEWARE **Zero.3**

LIME	CONCRETE	CEMENT	PORTLAND	SILICON
				
URBAN STRIPES* 50x100 cm Rect - 19 ¹ / ₂ "x39" ± 3 mm PZ9UNS0	URBAN STRIPES* 50x100 cm Rect - 19 ¹ / ₂ "x39" ± 3 mm PZ9UNS1	URBAN STRIPES* 50x100 cm Rect - 19 ¹ / ₂ "x39" ± 3 mm PZ9UNS2	URBAN STRIPES* 50x100 cm Rect - 19 ¹ / ₂ "x39" ± 3 mm PZ9UNS3	URBAN STRIPES* 50x100 cm Rect - 19 ¹ / ₂ "x39" ± 3 mm PZ9UNS4
				
				
URBAN LEAVES 1* 50x100 cm Rect - 19 ¹ / ₂ "x39" ± 3 mm PZ9UNL1	URBAN LEAVES 2* 50x100 cm Rect - 19 ¹ / ₂ "x39" ± 3 mm PZ9UNL2			
				
URBAN TWEED 1 50x100 cm Rect - 19 ¹ / ₂ "x39" ± 3 mm PZ9UNT1	URBAN TWEED 2 50x100 cm Rect - 19 ¹ / ₂ "x39" ± 3 mm PZ9UNT2			

URBAN STRIPES, URBAN LEAVES 1, URBAN LEAVES 2, URBAN TWEED 1, URBAN TWEED 2:

Posare solo a parete_Recommended only for wall applications_Nur an der Wand verlegen_Recommandé seulement pour les revêtements























Protezione antibatterica non presente_No antimicrobial protection_Der Antibakterielle Schutz nicht vorhanden_Protection antibactérienne pas présente

* Sviluppato su 2 soggetti, venduto solo a scatole complete_Developed on 2 patterns, full boxes order only_Paarweise, nur als komplette Verpackung erhältlich_Développé sur 2 éléments, vendu uniquement en boîtes complètes

Urbanature

DECORI_DECORS

GRES PORCELLANATO A MASSA COLORATA_COLOURED-BODY PORCELAIN STONEWARE

LIME	CONCRETE	CEMENT	PORTLAND	SILICON
				
URBAN STEEL NATURALE 60x60 cm Rect - 24"x24" ± 9,5 mm PGWUNS0	URBAN STEEL NATURALE 60x60 cm Rect - 24"x24" ± 9,5 mm PGWUNS1	URBAN STEEL NATURALE 60x60 cm Rect - 24"x24" ± 9,5 mm PGWUNS2	URBAN STEEL NATURALE 60x60 cm Rect - 24"x24" ± 9,5 mm PGWUNS3	URBAN STEEL NATURALE 60x60 cm Rect - 24"x24" ± 9,5 mm PGWUNS4
				
URBAN WAVY NATURALE 15x60 cm Rect - 6"x24" ± 9,5 mm PG1UN00	URBAN WAVY NATURALE 15x60 cm Rect - 6"x24" ± 9,5 mm PG1UN10		URBAN WAVY NATURALE 15x60 cm Rect - 6"x24" ± 9,5 mm PG1UN30	URBAN WAVY NATURALE 15x60 cm Rect - 6"x24" ± 9,5 mm PG1UN40
				
MOSAICO 16 PEZZI NATURALE 30x30 cm Rect - 12"x12" ± 9,5 mm PGZUN00	MOSAICO 16 PEZZI NATURALE 30x30 cm Rect - 12"x12" ± 9,5 mm PGZUN10	MOSAICO 16 PEZZI NATURALE 30x30 cm Rect - 12"x12" ± 9,5 mm PGZUN20	MOSAICO 16 PEZZI NATURALE 30x30 cm Rect - 12"x12" ± 9,5 mm PGZUN30	MOSAICO 16 PEZZI NATURALE 30x30 cm Rect - 12"x12" ± 9,5 mm PGZUN40
LIME		PORTLAND	SILICON	
				
URBAN WOOD* 45x90 cm Rect - 18"x36" ± 9,5 mm PGHUN04G		URBAN WOOD* 45x90 cm Rect - 18"x36" ± 9,5 mm PGHUN34G	URBAN WOOD* 45x90 cm Rect - 18"x36" ± 9,5 mm PGHUN44G	URBAN WOOD LISTONE* 22,5x90 cm Rect - 9"x36" ± 9,5 mm PG2UN54
CONCRETE		PORTLAND		
				
URBAN TEXTURE* 30x60 cm Rect - 12"x24" ± 9,5 mm PG-UN13	LISTELLO URBAN TEXTURE* 6x60 cm Rect - 2 ³ / ₈ "x24" ± 9,5 mm PGTUN13	URBAN TEXTURE* 30x60 cm Rect - 12"x24" ± 9,5 mm PG-UN33	LISTELLO URBAN TEXTURE* 6x60 cm Rect - 2 ³ / ₈ "x24" ± 9,5 mm PGTUN33	

URBAN WOOD, URBAN WOOD LISTONE, URBAN TEXTURE, LISTELLO URBAN TEXTURE, URBAN WAVY, URBAN STEEL:

Posare solo a parete_Recommended only for wall applications_Nur an der Wand verlegen_Recommandé seulement pour les revêtements



Protezione antibatterica non presente_No antimicrobial protection_Der Antibakterielle Schutz nicht vorhanden_Protection antibactérienne pas présente

Urbanature

PEZZI SPECIALI_TRIM PIECES

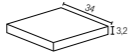
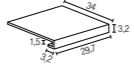
GRES PORCELLANATO A MASSA COLORATA_COLOURED-BODY PORCELAIN STONWARE

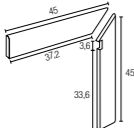
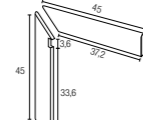
		
BATTISCOPA 10x60 cm Rect - 4"x24" ± 10 mm NATURALE	ANGOLO GRADONE A COSTA RETTA 34x34 cm - 13 ^{3/8} "x13 ^{3/8} " ± 9,5 mm NATURALE	GRADONE A COSTA RETTA 30x34 cm Rect - 12"x13 ^{3/8} " ± 9,5 mm NATURALE
LIME	PGRUNR01	PGEUN01
CONCRETE	PGRUNR1	PGEUN11
CEMENT	PGRUNR21	PGEUN21
PORTLAND	PGRUNR3	PGEUN31
SILICON	PGRUNR4	PGEUN41





			
BATTISCOPA SCALA DX (kit 2 pezzi) 10x45 cm - 4"x18" ± 10 mm NATURALE	BATTISCOPA SCALA SX (kit 2 pezzi) 10x45 cm - 4"x18" ± 10 mm NATURALE	RACCORDO 1x30 cm Rect - 3/8"x12" NATURALE	ANGOLO RACCORDO 1x1 cm - 3/8"x3/8" NATURALE
LIME	PGZUN0D	PGZUN0S	PGZUNR0
CONCRETE	PGZUN1D	PGZUN1S	PGZUNR1
CEMENT	PGZUN2D	PGZUN2S	PGZUNR2
PORTLAND	PGZUN3D	PGZUN3S	PGZUNR3
SILICON	PGZUN4D	PGZUN4S	PGZUNR4

RACCORDO, ANGOLO RACCORDO:

Posare solo all'interno_Strictly for interiors_Nur im Innenraum zu verlegen_Poser seulement à l'intérieur

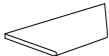
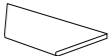
Protezione antibatterica non presente_No antimicrobial protection_Der Antibakterielle Schutz nicht vorhanden_Protection antibactérienne pas présente

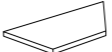
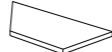
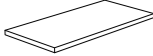

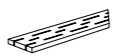
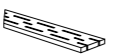
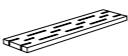



GRES PORCELLANATO A MASSA COLORATA_COLOURED-BODY PORCELAIN STONWARE 20 mm

					
COSTA TORO ANGOLARE DX 30x60 cm Rect - 12"x24" STRUTTURATO*	COSTA TORO ANGOLARE SX 30x60 cm Rect - 12"x24" STRUTTURATO*	COSTA TORO 30x60 cm Rect - 12"x24" STRUTTURATO*	COSTA TORO GRIP 30x60 cm Rect - 12"x24" STRUTTURATO*	COSTA RETTA ANGOLARE DX 30x60 cm Rect - 12"x24" STRUTTURATO*	COSTA RETTA ANGOLARE SX 30x60 cm Rect - 12"x24" STRUTTURATO*
CEMENT	PGDUNK4	PGDUNK2	PGDUNF2	PGDUNJ2	PGDUND2
PORTLAND	PGDUNK5	PGDUNK3	PGDUNF3	PGDUNJ3	PGDUND3
					
COSTA RETTA 30x60 cm Rect - 12"x24" STRUTTURATO*	COSTA RETTA GRIP 30x60 cm Rect - 12"x24" STRUTTURATO*	GRIGLIA ANGOLARE DX 15x60 cm Rect - 6"x24" STRUTTURATO*	GRIGLIA ANGOLARE SX 15x60 cm Rect - 6"x24" STRUTTURATO*	GRIGLIA 15x60 cm Rect - 6"x24" STRUTTURATO*	
CEMENT	PGDUNC2	PGDUNA4	PGDUNA2	PGDUNZ2	
PORTLAND	PGDUNC3	PGDUNA5	PGDUNA3	PGDUNZ3	

* Protezione antibatterica non presente_No antimicrobial protection_Der Antibakterielle Schutz nicht vorhanden_Protection antibactérienne pas présente

Urbanature

IMBALLAGGI E PESI_PACKINGS AND WEIGHTS

DESCRIZIONE Description	± mm	FORMATI Sizes	SCATOLA_Box				PALLET		
									
FONDO NATURALE	3,5	100x300 RECT	1	23,4	3	-	20	468	60
FONDO NATURALE	3,5	100x100 RECT	3	23,4	3	-	25	585	75
FONDO NATURALE	3,5	50x100 RECT	5	19,5	2,5	-	32	624	80
URBAN STRIPES	3	50x100 RECT	2	7	1	-	25	175	25
URBAN LEAVES 1/2	3	50x100 RECT	2	7	1	-	25	175	25
URBAN TWEED 1/2	3	50x100 RECT	2	7	1	-	25	175	25
FONDO NATURALE / EXT	9,5	90x90 RECT	2	33,6	1,62	-	25	840	40,5
FONDO NATURALE	9,5	45x90 RECT	3	25,2	1,215	-	36	907,2	43,74
FONDO NATURALE	9,5	22,5x90 RECT	4	17,27	0,81	-	44	760	35,6
FONDO NATURALE	9,5	60x60 RECT	4	31,8	1,44	-	32	1018	46,1
FONDO NATURALE	9,5	30x60 RECT	8	31,8	1,44	-	32	1018	46,1
URBAN STEEL NATURALE	9,5	60x60 RECT	2	15,9	0,72	-	20	318	14,4
URBAN WAVY NATURALE	9,5	15x60 RECT	4	7,9	0,36	-	48	379	17,3
MOSAICO 16 PEZZI NATURALE	9,5	30x30 RECT	4	7,2	0,36	-	78	562	28,1
URBAN WOOD	9,5	45x90 RECT	2	17,2	0,81	-	15	258	12,15
URBAN WOOD LISTONE	9,5	22,5x90 RECT	2	8,6	0,4	-	45	389	18,2
URBAN TEXTURE	9,5	30x60 RECT	2	8	0,36	-	128	1024	46,1
LISTELLO URBAN TEXTURE	9,5	6x60 RECT	4	3	0,14	-	-	-	-
RACCORDO NATURALE	-	1x30 RECT	8	0,8	0,02	-	-	-	-
ANGOLO RACCORDO NATURALE	-	1x1	10	0,07	0,001	-	-	-	-
BATTISCOPA NATURALE	10	10x60 RECT	12	15,48	0,72	7,2	60	929	43,2
BATTISCOPA SCALA (KIT 2 PZ.) NATURALE	10	10x45	5	8,5	0,43	-	-	-	-
GRADONE A COSTA RETTA NATURALE	9,5	30x34 RECT	6	17,1	0,61	-	30	513	18,4
ANGOLO GRADONE A COSTA RETTA NATURALE	9,5	34x34	2	6,3	0,23	-	48	301	11,1
FONDO STRUTTURATO	20	60x60 RECT	2	33	0,72	-	32	1056	23,04
COSTA TORO STRUTTURATO	20	30x60 RECT	1	8,125	0,135	-	100	812,5	13,5
COSTA TORO ANGOLARE STRUTTURATO	20	30x60 RECT	1	6,1	0,135	-	100	610	13,5
COSTA TORO GRIP STRUTTURATO	20	30x60 RECT	1	8,125	0,135	-	100	812,5	13,5
COSTA RETTA STRUTTURATO	20	30x60 RECT	1	8,125	0,135	-	100	812,5	13,5
COSTA RETTA ANGOLARE STRUTTURATO	20	30x60 RECT	1	6,1	0,135	-	100	610	13,5
COSTA RETTA GRIP STRUTTURATO	20	30x60 RECT	1	8,125	0,135	-	100	812,5	13,5
GRIGLIA STRUTTURATO	20	15x60 RECT	2	8	0,158	-	100	800	15,8
GRIGLIA ANGOLARE STRUTTURATO	20	15x60 RECT	2	7	0,158	-	100	700	15,8



Effetto marmo

Marble look_Marmor-Optik_Effet marbre



Eternity



STATUARIO WHITE



ARABESQUE PEARL



BREACH GREY

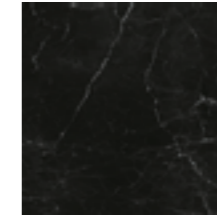

MARQUINA BLACK

GRES PORCELLANATO A MASSA COLORATA_COLOURED-BODY PORCELAIN STONEWARE



± 9,5 mm



60x120 cm Rect
24"x48"



60x60 cm Rect
24"x24"



30x60 cm Rect
12"x24"



PAVIMENTO / FLOOR Statuario White Lux 60x60 cm Rect - 24"x24"
Listello Marquina Black Lux 7x60 cm - 2³/₄"x24"_Quadrato Marquina Black Lux 7x7 cm - 2³/₄"x2³/₄"



PAVIMENTO / FLOOR Marquina Black Lux 60x60 cm Rect - 24"x24"
Angolo Classic 2 Lux 60x60 cm Rect - 24"x24" _Fascia Classic 2 Lux 60x60 cm Rect - 24"x24"



PAVIMENTO / FLOOR Chevron Statuario White Soft 9,5x54 cm Rect - 3³/₄"x21¹/₄"



RIVESTIMENTO / WALL Mosaico Kubic Arabesque Pearl Lux 17x29,2 cm Rect - 6^{5/8}"x11^{1/2}"_Arabesque Pearl Lux 30x60 cm Rect - 12"x24"
 Marquina Black Lux 60x120 cm Rect - 24"x48"

PAVIMENTO / FLOOR Arabesque Pearl Soft 60x60 cm Rect - 24"x24"_Marquina Black Soft 60x120 cm Rect - 24"x48"



RIVESTIMENTO / WALL Statuario White Soft 60x120 cm Rect - 24"x48"_Mosaico Gems B Lux 30x30 cm Rect - 12"x12"
PAVIMENTO / FLOOR Statuario White Soft 60x120 cm Rect - 24"x48"

Eternity

P R () T E C T
ANTIBATTERICO - ANTIMICROBIAL

Eternity

STATUARIO WHITE



ARABESQUE PEARL



BREACH GREY



MARQUINA BLACK

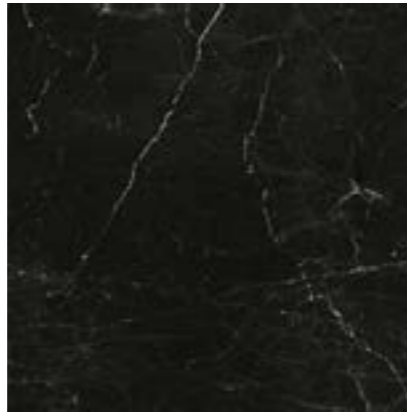

GRES PORCELLANATO A MASSA COLORATA_COLOURED-BODY PORCELAIN STONEWARE

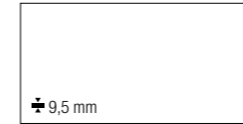

60x120 cm Rect - 24"x48"

Statuario White SOFT	PGXEN20
Arabesque Pearl SOFT	PGXEN00
Breach Grey SOFT	PGXEN10
Marquina Black SOFT	PGXEN30
Statuario White LUX	PGXEN25
Arabesque Pearl LUX	PGXEN05
Breach Grey LUX	PGXEN15
Marquina Black LUX	PGXEN35



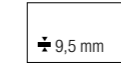

60x60 cm Rect - 24"x24"

Statuario White SOFT	PGWEN20
Arabesque Pearl SOFT	PGWEN00
Breach Grey SOFT	PGWEN10
Marquina Black SOFT	PGWEN30
Statuario White LUX	PGWEN25
Arabesque Pearl LUX	PGWEN05
Breach Grey LUX	PGWEN15
Marquina Black LUX	PGWEN35



30x60 cm Rect - 12"x24"

Statuario White SOFT	PGVEN20
Arabesque Pearl SOFT	PGVEN00
Breach Grey SOFT	PGVEN10
Marquina Black SOFT	PGVEN30
Statuario White LUX	PGVEN25
Arabesque Pearl LUX	PGVEN05
Breach Grey LUX	PGVEN15
Marquina Black LUX	PGVEN35

DESTINAZIONI D'USO_INTENDED USE: SOFT / LUX  

DATI TECNICI_TECHNICAL DATA:

GRES PORCELLANATO A MASSA COLORATA
COLOURED-BODY PORCELAIN STONEWARE

 9,5 mm

 ANSI A326.3: ID - DCOF \geq 0.42 (dry) Soft - Lux
IW - DCOF \geq 0.42 (wet) Soft

 ANSI A137.3: V2 Soft - Lux

P R () T E C T
ANTIBATTERICO - ANTIMICROBIAL Soft - Lux

Eternity

DECORI_DECORS

GRES PORCELLANATO A MASSA COLORATA_COLOURED-BODY PORCELAIN STONEWARE

STATUARIO WHITE

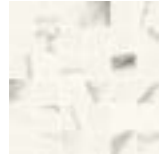

MOSAICO 36 SOFT
30x30 cm Rect - 12"x12"
± 9,5 mm
PGZEN62



MOSAICO KUBIC LUX
17x29,2 cm Rect - 6^{5/8}"x11^{1/2}"
± 9,5 mm
PGZENK2

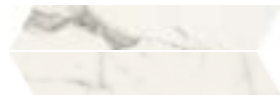

CHEVRON SOFT
9,5x54 cm Rect - 3^{3/4}"x21^{1/4}"
± 9,5 mm
PGZENC2



LISTELLO LUX
7x60 cm Rect - 2^{3/4}"x24"
± 9,5 mm
PGZENL2



QUADRATO LUX
7x7 cm Rect - 2^{3/4}"x2^{3/4}"
± 9,5 mm
PGZENQ2

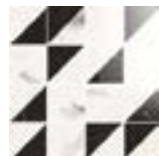

MOSAICO GEMS B LUX
(Statuario White - Marquina Black)
30x30 cm Rect - 12"x12"
± 9,5 mm
PGZEN51

ARABESQUE PEARL

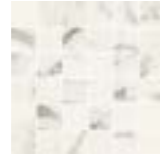

MOSAICO 36 SOFT
30x30 cm Rect - 12"x12"
± 9,5 mm
PGZEN60



MOSAICO KUBIC LUX
17x29,2 cm Rect - 6^{5/8}"x11^{1/2}"
± 9,5 mm
PGZENK0

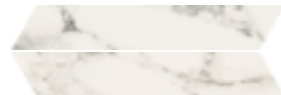

CHEVRON SOFT
9,5x54 cm Rect - 3^{3/4}"x21^{1/4}"
± 9,5 mm
PGZENC0



LISTELLO LUX
7x60 cm Rect - 2^{3/4}"x24"
± 9,5 mm
PGZENL0



QUADRATO LUX
7x7 cm Rect - 2^{3/4}"x2^{3/4}"
± 9,5 mm
PGZENQ0

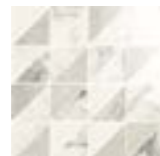

MOSAICO GEMS A LUX
(Arabesque Pearl - Breach Grey)
30x30 cm Rect - 12"x12"
± 9,5 mm
PGZEN50

BREACH GREY



MOSAICO 36 SOFT
30x30 cm Rect - 12"x12"
± 9,5 mm
PGZEN61



MOSAICO KUBIC LUX
17x29,2 cm Rect - 6^{5/8}"x11^{1/2}"
± 9,5 mm
PGZENK1

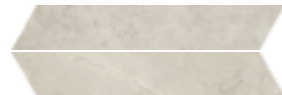

CHEVRON SOFT
9,5x54 cm Rect - 3^{3/4}"x21^{1/4}"
± 9,5 mm
PGZENC1



LISTELLO LUX
7x60 cm Rect - 2^{3/4}"x24"
± 9,5 mm
PGZENL1



QUADRATO LUX
7x7 cm Rect - 2^{3/4}"x2^{3/4}"
± 9,5 mm
PGZENQ1

MARQUINA BLACK



MOSAICO 36 SOFT
30x30 cm Rect - 12"x12"
± 9,5 mm
PGZEN63



MOSAICO KUBIC LUX
17x29,2 cm Rect - 6^{5/8}"x11^{1/2}"
± 9,5 mm
PGZENK3



CHEVRON SOFT
9,5x54 cm Rect - 3^{3/4}"x21^{1/4}"
± 9,5 mm
PGZENC3



LISTELLO LUX
7x60 cm Rect - 2^{3/4}"x24"
± 9,5 mm
PGZENL3



QUADRATO LUX
7x7 cm Rect - 2^{3/4}"x2^{3/4}"
± 9,5 mm
PGZENQ3

Eternity

DECORI_DECORS

GRES PORCELLANATO A MASSA COLORATA_COLOURED-BODY PORCELAIN STONEWARE

STATUARIO WHITE



ANGOLO CLASSIC 1 LUX
(Statuario White - Marquina Black)
60x60 cm Rect - 24"x24"
± 9,5 mm
PGWENA1



FASCIA CLASSIC 1 LUX
(Statuario White - Marquina Black)
60x60 cm Rect - 24"x24"
± 9,5 mm
PGWENF1

MARQUINA BLACK



ANGOLO CLASSIC 2 LUX
(Marquina Black - Statuario White)
60x60 cm Rect - 24"x24"
± 9,5 mm
PGWENA2



FASCIA CLASSIC 2 LUX
(Marquina Black - Statuario White)
60x60 cm Rect - 24"x24"
± 9,5 mm
PGWENF2



FASCIA E ANGOLO CLASSIC 1 LUX

Esempio composizione 6 pz_6 pz composition example_Beispiel
Zusammensetzung 6 Stk_Exemple de composition 6 pièces



FASCIA E ANGOLO CLASSIC 2 LUX

Esempio composizione 6 pz_6 pz composition example_Beispiel
Zusammensetzung 6 Stk_Exemple de composition 6 pièces

MOSAICO KUBIC, MOSAICO GEMS A, MOSAICO GEMS B:

Posare solo a parete_Recommended only for wall applications_Nur an der Wand verlegen_Recommandé seulement pour les revêtements

Eternity

ESEMPI COMPOSIZIONI_TILE LAYOUT EXAMPLES



LISTELLO Marquina Black Lux 7x60 cm Rect
 QUADRATO Marquina Black Lux 7x7 cm Rect
 FONDO Statuario White Lux 60x60 cm Rect

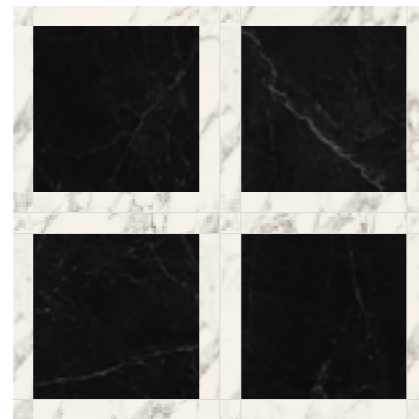

LISTELLO Arabesque Pearl Lux 7x60 cm Rect
 QUADRATO Arabesque Pearl Lux 7x7 cm Rect
 FONDO Marquina Black Lux 60x60 cm Rect

Per questo tipo di posa Listello e Quadrato Eternity sono abbinabili tra loro e con tutti i fondi 60x60 rettificati delle collezioni a catalogo. For this laying solution Eternity Listello and Quadrato are matchable with the 60x60 rectified of all collections. Bei dieser Art von Verlegung sind Listello und Quadrato Eternity untereinander und mit allen begradtigten 60x60 Untergründen der Katalogkollektionen kombinierbar. Pour ce type de pose Listello et Quadrato Eternity sont combinables entre eux et avec tous les fonds de 60x60 rectifiés des collections du catalogue.

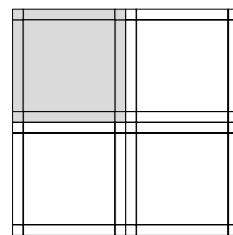

Modulo A_Module A_Modul A_Module A

4 PEZZI 7x60 (30,68%)
 4 PEZZI 7x7 (3,58%)
 1 PEZZO 60x60 (65,74%)

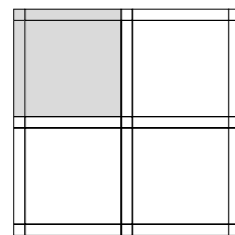

Modulo B_Module B_Modul B_Module B

2 PEZZI 7x60 (18,71%)
 1 PEZZI 7x7 (1,09%)
 1 PEZZO 60x60 (80,20%)

PEZZI SPECIALI_TRIM PIECES

GRES PORCELLANATO A MASSA COLORATA_COLOURED-BODY PORCELAIN STONWARE

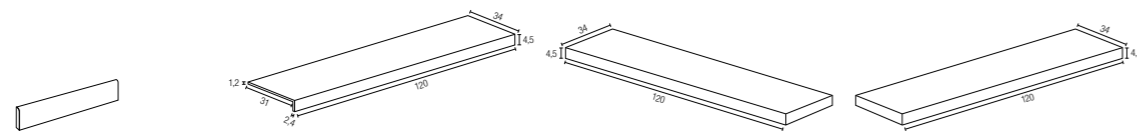

BATTISCOPA
 10x60 cm Rect - 4"x24"
 ± 9,5 mm

GRADINO PLUS BORDO*
 34x120x4,5 cm Rect - 13^{3/8}"x48"x1^{3/4}"
 ± 9,5 mm

GRADINO PLUS ANGOLARE DX*
 34x120x4,5 cm Rect - 13^{3/8}"x48"x1^{3/4}"
 ± 9,5 mm

GRADINO PLUS ANGOLARE SX*
 34x120x4,5 cm Rect - 13^{3/8}"x48"x1^{3/4}"
 ± 9,5 mm

	SOFT	LUX	SOFT	LUX*	SOFT	LUX*	SOFT	LUX*
STATUARIO WHITE	PGREN20	PGREN25	PGDEN20	PGDEN70	PGDEN21	PGDEN71	PGDEN22	PGDEN72
ARABESQUE PEARL	PGREN00	PGREN05	PGDEN00	PGDEN50	PGDEN01	PGDEN51	PGDEN02	PGDEN52
BREACH GREY	PGREN10	PGREN15	PGDEN10	PGDEN60	PGDEN11	PGDEN61	PGDEN12	PGDEN62
MARQUINA BLACK	PGREN30	PGREN35	PGDEN30	PGDEN80	PGDEN31	PGDEN81	PGDEN32	PGDEN82

* Lavorati solo su richiesta_Manufactured only upon special request_Nur auf Anfrage_Seulement à la demande

IMBALLAGGI E PESI_PACKINGS AND WEIGHTS

DESCRIZIONE Description	± mm	FORMATI Sizes	SCATOLA_Box				PALLET		
			📦	📊 KG	📊 M ²	📊 ML	📦	📊 KG	📊 M ²
FONDO SOFT / LUX	9,5	60x120 ^{RECT}	2	31,8	1,44	-	36	1144,8	51,84
FONDO SOFT / LUX	9,5	60x60 ^{RECT}	4	31,8	1,44	-	32	1017,6	46,08
FONDO SOFT / LUX	9,5	30x60 ^{RECT}	8	31,8	1,44	-	32	1017,6	46,08
MOSAICO 36 SOFT	9,5	30x30 ^{RECT}	4	7,5	0,36	-	78	585	28,08
MOSAICO KUBIC LUX	9,5	17x29,2 ^{RECT}	4	4,085	0,198	-	60	245,1	11,914
CHEVRON SOFT	9,5	9,5x54 ^{RECT}	8	9,215	0,41	-	64	589,76	26,266
MOSAICO GEMS A/B LUX	9,5	30x30 ^{RECT}	4	7,41	0,36	-	48	355,68	17,28
ANGOLO CLASSIC 1/2 LUX	9,5	60x60 ^{RECT}	4	31,8	1,44	-	-	-	-
FASCIA CLASSIC 1/2 LUX	9,5	60x60 ^{RECT}	2	15,9	0,72	-	-	-	-
LISTELLO LUX	9,5	7x60 ^{RECT}	16	13,78	0,672	-	40	551	26,88
QUADRATO LUX	9,5	7x7 ^{RECT}	16	1,615	0,078	-	456	736,44	35,75
BATTISCOPA SOFT / LUX	9,5	10x60 ^{RECT}	12	15	0,72	7,2	60	900	43,2
GRADINO PLUS BORDO SOFT / LUX	9,5	34x120x4,5 ^{RECT}	2	33,25	0,816	-	12	399	9,792
GRADINO PLUS ANGOLARE SOFT / LUX	9,5	34x120x4,5 ^{RECT}	1	16,625	0,408	-	24	399	9,792



RIVESTIMENTO / WALL Mosaico Kubic Arabesque Pearl Lux 17x29,2 cm Rect - 6^{5/8}"x11^{1/2}"



Trilogy



CALACATTA WHITE

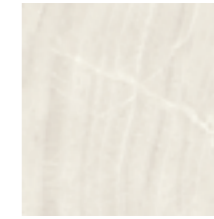

ONYX LIGHT

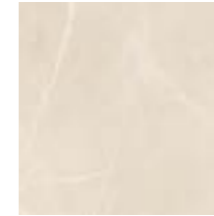

MOON BEIGE

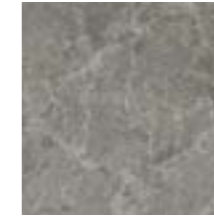

SANDY GREY

GRES PORCELLANATO LAMINATO_LAMINATED PORCELAIN STONWARE **Zero.3**



± 5,5 mm



100x300 cm Rect
39"x118"

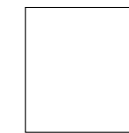

100x100 cm Rect
39"x39"



50x100 cm Rect
19 1/2"x39"

GRES PORCELLANATO A MASSA COLORATA_COLOURED-BODY PORCELAIN STONWARE



± 9,5 mm



60x120 cm Rect
24"x48"



60x60 cm Rect
24"x24"



30x60 cm Rect
12"x24"



RIVESTIMENTO / WALL Moon Beige Soft 100x300 cm Rect - 39"x118"
PAVIMENTO / FLOOR Moon Beige Soft 60x60 cm Rect - 24"x24"



RIVESTIMENTO / WALL Onyx Light Soft 100x300 cm Rect - 39"x118"
PAVIMENTO / FLOOR Onyx Light Lux 60x120 cm Rect - 24"x48"



RIVESTIMENTO / WALL Calacatta White Lux 100x300 cm Rect - 39"x118"
PAVIMENTO / FLOOR Calacatta White Lux 100x100 cm Rect - 39"x39"



RIVESTIMENTO / WALL Mosaico 36 Onyx Light Lux 29x29 cm Rect - 11 1/2"x11 1/2"



RIVESTIMENTO / WALL Onyx Light Soft 7,5x30 cm Rect - 3"x12"



PAVIMENTO / FLOOR Chevron Sandy Grey Soft 9,5x54 cm Rect - 3/4"x21 1/4"

Trilogy

PR()TECT
ANTIBATTERICO - ANTIMICROBIAL

CALACATTA WHITE

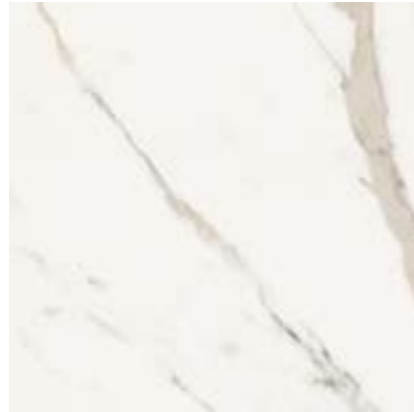

ONYX LIGHT



MOON BEIGE



SANDY GREY



Trilogy

GRES PORCELLANATO LAMINATO_LAMINATED PORCELAIN STONEWARE **Zero.3**

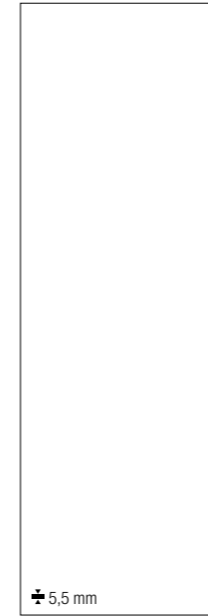

100x300 cm Rect - 39"x118"

Calacatta White SOFT	PZ7TY00
Onyx Light SOFT	PZ7TY20
Moon Beige SOFT	PZ7TY10
Sandy Grey SOFT	PZ7TY30
Calacatta White LUX	PZ7TYX0
Onyx Light LUX	PZ7TYX2
Moon Beige LUX	PZ7TYX1
Sandy Grey LUX	PZ7TYX3



100x100 cm Rect - 39"x39"

Calacatta White SOFT	PZ8TY00
Onyx Light SOFT	PZ8TY20
Moon Beige SOFT	PZ8TY10
Sandy Grey SOFT	PZ8TY30
Calacatta White LUX	PZ8TYX0
Onyx Light LUX	PZ8TYX2
Moon Beige LUX	PZ8TYX1
Sandy Grey LUX	PZ8TYX3

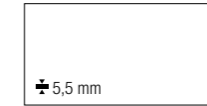

50x100 cm Rect - 19 1/2"x39"

Calacatta White SOFT	PZ9TYS0
Onyx Light SOFT	PZ9TYS2
Moon Beige SOFT	PZ9TYS1
Sandy Grey SOFT	PZ9TYS3
Calacatta White LUX	PZ9TYX0
Onyx Light LUX	PZ9TYX2
Moon Beige LUX	PZ9TYX1
Sandy Grey LUX	PZ9TYX3

GRES PORCELLANATO A MASSA COLORATA_COLOURED-BODY PORCELAIN STONEWARE

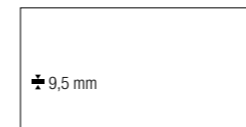

60x120 cm Rect - 24"x48"

Calacatta White SOFT	PGXTY052
Onyx Light SOFT	PGXTY252
Moon Beige SOFT	PGXTY152
Sandy Grey SOFT	PGXTY352
Calacatta White LUX*	PGXTY50
Onyx Light LUX*	PGXTY52
Moon Beige LUX*	PGXTY51
Sandy Grey LUX*	PGXTY53

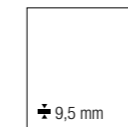

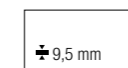

60x60 cm Rect - 24"x24"

Calacatta White SOFT	PGWTY05
Onyx Light SOFT	PGWTY25
Moon Beige SOFT	PGWTY15
Sandy Grey SOFT	PGWTY35
Calacatta White LUX*	PGWTY60
Onyx Light LUX*	PGWTY62
Moon Beige LUX*	PGWTY61
Sandy Grey LUX*	PGWTY63







30x60 cm Rect - 12"x24"

Calacatta White SOFT	PG-TY05
Onyx Light SOFT	PG-TY25
Moon Beige SOFT	PG-TY15
Sandy Grey SOFT	PG-TY35
Calacatta White LUX*	PG-TY60
Onyx Light LUX*	PG-TY62
Moon Beige LUX*	PG-TY61
Sandy Grey LUX*	PG-TY63

DESTINAZIONI D'USO_INTENDED USE: SOFT / LUX  

DATI TECNICI_TECHNICAL DATA:

GRES PORCELLANATO LAMINATO LAMINATED PORCELAIN STONEWARE		GRES PORCELLANATO A MASSA COLORATA COLOURED-BODY PORCELAIN STONEWARE	
+	5,5 mm	+	9,5 mm
	ANSI A326.3: ID - DCOF ≥ 0.42 (dry) Soft - Lux IW - DCOF ≥ 0.42 (wet) Soft		ANSI A326.3: ID - DCOF ≥ 0.42 (dry) Soft - Lux IW - DCOF ≥ 0.42 (wet) Soft
	ANSI A137.3: V2 Soft - Lux		ANSI A137.1: V2 Soft - Lux
PR()TECT ANTIBATTERICO - ANTIMICROBIAL	Soft - Lux	PR()TECT ANTIBATTERICO - ANTIMICROBIAL	Soft

* Protezione antibatterica non presente_No antimicrobial protection_Der Antibakterielle Schutz nicht vorhanden_Protection antibactérienne pas présente

Trilogy

DECORI_DECORS

GRES PORCELLANATO A MASSA COLORATA_COLOURED-BODY PORCELAIN STONEWARE

CALACATTA WHITE

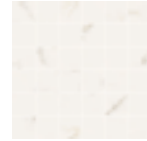

MOSAICO 36 SOFT
30x30 cm Rect - 12"x12"
± 9,5 mm
PGZTY00



MOSAICO 36 LUX*
29x29 cm Rect - 11 1/2"x11 1/2"
± 9,5 mm
PGZTYL0



MOSAICO 72 1 LUX*
30x30 cm Rect - 12"x12"
± 9,5 mm
PGZTY71

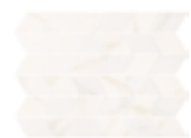

MOSAICO FRECCIA SOFT
30x34,5 cm Rect - 12"x13 3/4"
± 9,5 mm
PGZTYE0



CHEVRON SOFT
9,5x54 cm Rect - 3 3/4"x21 1/4"
± 9,5 mm
PGZTYC0



7,5x30 cm Rect - 3"x12"
± 9,5 mm
PGZTYM01 SOFT

ONYX LIGHT



MOSAICO 36 SOFT
30x30 cm Rect - 12"x12"
± 9,5 mm
PGZTY20



MOSAICO 36 LUX*
29x29 cm Rect - 11 1/2"x11 1/2"
± 9,5 mm
PGZTYL2



MOSAICO 72 2 LUX*
30x30 cm Rect - 12"x12"
± 9,5 mm
PGZTY72



MOSAICO FRECCIA SOFT
30x34,5 cm Rect - 12"x13 3/4"
± 9,5 mm
PGZTYE2



CHEVRON SOFT
9,5x54 cm Rect - 3 3/4"x21 1/4"
± 9,5 mm
PGZTYC2



7,5x30 cm Rect - 3"x12"
± 9,5 mm
PGZTYM21 SOFT

MOON BEIGE



MOSAICO 36 SOFT
30x30 cm Rect - 12"x12"
± 9,5 mm
PGZTY10



MOSAICO 36 LUX*
29x29 cm Rect - 11 1/2"x11 1/2"
± 9,5 mm
PGZTYL1



MOSAICO 72 2 LUX*
30x30 cm Rect - 12"x12"
± 9,5 mm
PGZTY72



MOSAICO FRECCIA SOFT
30x34,5 cm Rect - 12"x13 3/4"
± 9,5 mm
PGZTYE1



CHEVRON SOFT
9,5x54 cm Rect - 3 3/4"x21 1/4"
± 9,5 mm
PGZTYC1



7,5x30 cm Rect - 3"x12"
± 9,5 mm
PGZTYM11 SOFT

SANDY GREY



MOSAICO 36 SOFT
30x30 cm Rect - 12"x12"
± 9,5 mm
PGZTY30



MOSAICO 36 LUX*
29x29 cm Rect - 11 1/2"x11 1/2"
± 9,5 mm
PGZTYL3



MOSAICO 72 2 LUX*
30x30 cm Rect - 12"x12"
± 9,5 mm
PGZTY72



MOSAICO FRECCIA SOFT
30x34,5 cm Rect - 12"x13 3/4"
± 9,5 mm
PGZTYE3



CHEVRON SOFT
9,5x54 cm Rect - 3 3/4"x21 1/4"
± 9,5 mm
PGZTYC3



7,5x30 cm Rect - 3"x12"
± 9,5 mm
PGZTYM31 SOFT

MOSAICO FRECCIA:

Posare solo a parete_Recommended only for wall applications_Nur an der Wand verlegen_Recommandé seulement pour les revêtements

* Protezione antibatterica non presente_No antimicrobial protection_Der Antibakterielle Schutz nicht vorhanden_Protection antibactérienne pas présente

Trilogy

PEZZI SPECIALI_TRIM PIECES

GRES PORCELLANATO A MASSA COLORATA_COLOURED-BODY PORCELAIN STONEWARE

	BATTISCOPA 10x60 cm Rect - 4"x24" ± 9,5 mm		GRADINO PLUS BORDO* 34x120x4,5 cm Rect - 13 3/8"x48"x1 3/4" ± 9,5 mm		GRADINO PLUS ANGOLARE DX* 34x120x4,5 cm Rect - 13 3/8"x48"x1 3/4" ± 9,5 mm		GRADINO PLUS ANGOLARE SX* 34x120x4,5 cm Rect - 13 3/8"x48"x1 3/4" ± 9,5 mm	
	SOFT	LUX**	SOFT	LUX**	SOFT	LUX**	SOFT	LUX**
CALACATTA WHITE	PGRTY00A	PGRTY60	PGDTY00	PGDTY55	PGDTY01	PGDTY56	PGDTY02	PGDTY57
ONYX LIGHT	PGRTY20A	PGRTY62	PGDTY20	PGDTY75	PGDTY21	PGDTY76	PGDTY22	PGDTY77
MOON BEIGE	PGRTY10A	PGRTY61	PGDTY10	PGDTY65	PGDTY11	PGDTY66	PGDTY12	PGDTY67
SANDY GREY	PGRTY30A	PGRTY63	PGDTY30	PGDTY85	PGDTY31	PGDTY86	PGDTY32	PGDTY87

* Lavorati solo su richiesta_Manufactured only upon special request_Nur auf Anfrage_Seulement à la demande

** Protezione antibatterica non presente_No antimicrobial protection_Der Antibakterielle Schutz nicht vorhanden_Protection antibactérienne pas présente

IMBALLAGGI E PESI_PACKINGS AND WEIGHTS

DESCRIZIONE Description	± mm	FORMATI Sizes	SCATOLA_Box				PALLET		
FONDO SOFT / LUX	5,5	100x300 ^{RECT}	1	34,5	3	-	13	448,5	39
FONDO SOFT / LUX	5,5	100x100 ^{RECT}	2	23	2	-	25	575	50
FONDO SOFT / LUX	5,5	50x100 ^{RECT}	3	18,9	1,5	-	32	604,8	48
FONDO SOFT / LUX	9,5	60x120 ^{RECT}	2	31,8	1,44	-	36	1144,8	51,84
FONDO SOFT / LUX	9,5	60x60 ^{RECT}	4	31,8	1,44	-	32	1017,6	46,08
FONDO SOFT / LUX	9,5	30x60 ^{RECT}	8	31,8	1,44	-	32	1017,6	46,08
MOSAICO 36 SOFT	9,5	30x30 ^{RECT}	4	7,5	0,36	-	78	585	28,08
MOSAICO 36 LUX	9,5	29x29 ^{RECT}	4	7,13	0,336	-	60	427,5	20,18
MOSAICO FRECCIA SOFT	9,5	30x34,5 ^{RECT}	4	9,3	0,414	-	-	-	-
MOSAICO 72 1/2 LUX	9,5	30x30 ^{RECT}	4	7,5	0,36	-	78	585	28,08
CHEVRON SOFT	9,5	9,5x54 ^{RECT}	8	9,2	0,407	-	64	589,76	26,02
FONDO SOFT	9,5	7,5x30 ^{RECT}	16	7,6	0,36	-	84	638,4	30,24
BATTISCOPA SOFT / LUX	9,5	10x60 ^{RECT}	12	15	0,72	7,2	60	900	43,2
GRADINO PLUS BORDO SOFT / LUX	9,5	34x120x4,5 ^{RECT}	2	33,25	0,816	-	12	399	9,79
GRADINO PLUS ANGOLARE SOFT / LUX	9,5	34x120x4,5 ^{RECT}	1	16,63	0,408	-	24	399	9,79



Effetto legno

Wood look_Holz-Optik_Effet bois



Assi d'Alpe



CHALET



CIASA



MASO

GRES PORCELLANATO A MASSA COLORATA_COLOURED-BODY PORCELAIN STONEWARE



± 9,5 mm



20x90,5 cm
8"x36"



PAVIMENTO / FLOOR Chalet Naturale 20x90,5 cm - 8"x36"

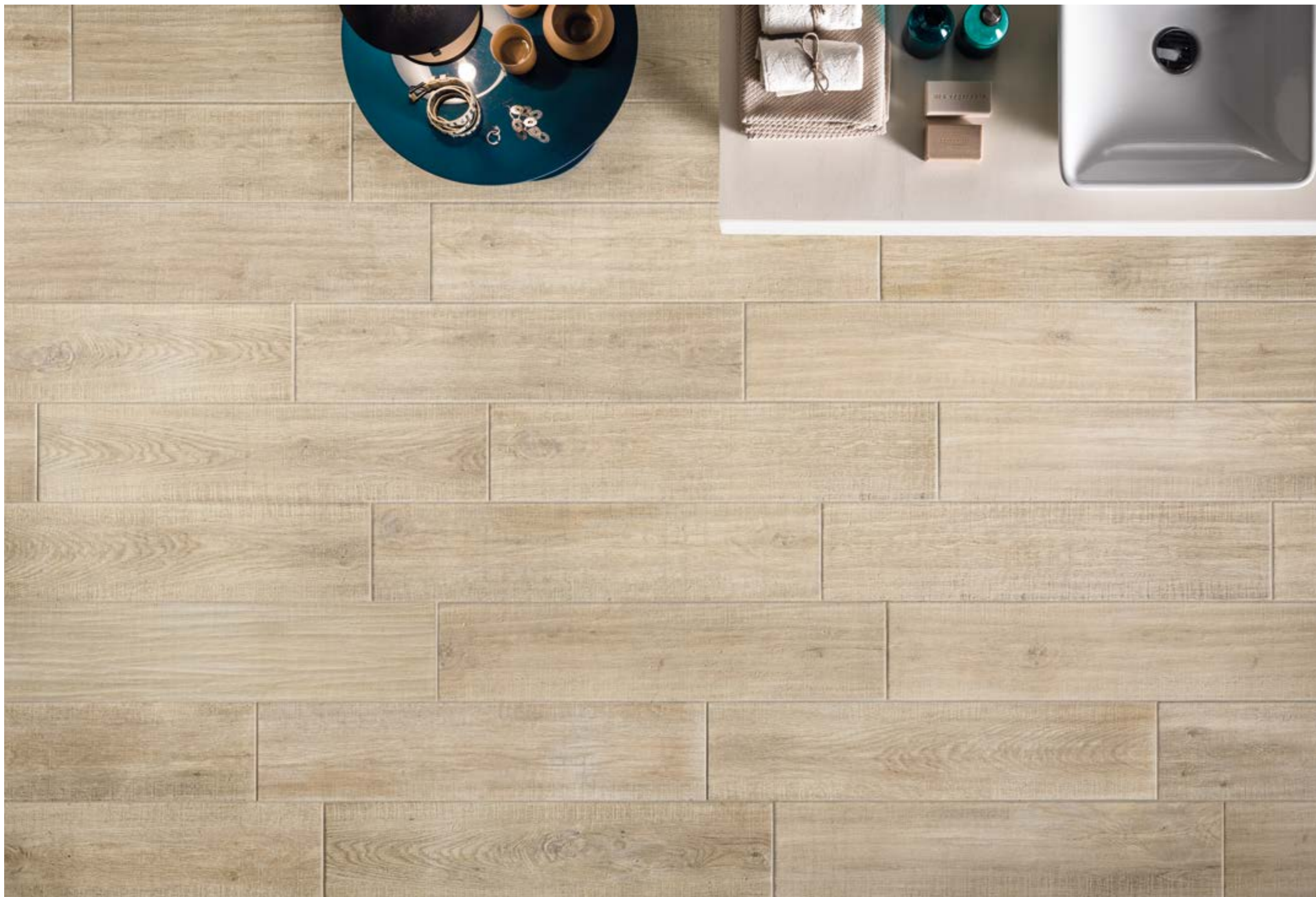

PAVIMENTO / FLOOR Ciasa Naturale 20x90,5 cm - 8"x36"

Assi d'Alpe

CHALET



CIASA









MASO



DESTINAZIONI D'USO_INTENDED USE: NATURALE   

DATI TECNICI_TECHNICAL DATA:

GRES PORCELLANATO A MASSA COLORATA COLOURED-BODY PORCELAIN STONEWARE	
	9,5 mm
 DIN EN 16165 - Annex B:	R10 Naturale
 DIN EN 16165 - Annex A:	A Naturale
 BCR TORTUS:	$\mu > 0,40$ Naturale
 ANSI A326.3:	ID - DCOF ≥ 0.42 (dry) Naturale
	IW - DCOF ≥ 0.42 (wet) Naturale
	IW+ Naturale*
 ANSI A137.1:	V2 Naturale (Ciasa-Chalet)
	V3 Naturale (Maso)
P R () T E C T ** <small>ANTIBATTERICO - ANTIMICROBIAL</small>	Naturale

* Ad eccezione delle zone caratterizzate da un maggior rischio di scivolamento (come docce pubbliche, piscine coperte, ecc.) per le quali si consiglia una superficie antiscivolo
With the exception of areas characterized by a higher risk of slipping (such as public showers, indoor swimming pools, etc.) for which a non-slip surface is recommended

** Per ordini superiori ai 1.000 Mq può essere richiesta la protezione antibatterica con una maggiorazione di 2,5€ netti al Mq. For orders above 1.000 Sqm the anti-bacterial protection may be requested and added, with a €2,50/Sqm net price increase. Sie koennen den antibakterielle Hygieneschutz von nachfragen für alle Aufträge ab 1000 QM, mit einer Preiserhöhung von Euro 2,50/QM netto. Pour commandes supérieures à 1.000 m² vous pouvez demander la protection antibactérienne avec un prix majoré de 2,5 Euro net/m²

Assi d'Alpe

GRES PORCELLANATO A MASSA COLORATA_COLOURED-BODY PORCELAIN STONEWARE

 9,5 mm

20x90,5 cm - 8"x36"

Chalet NATURALE PG2DA001

Ciasa NATURALE PG2DA201

Maso NATURALE PG2DA401

PEZZI SPECIALI_TRIM PIECES

GRES PORCELLANATO A MASSA COLORATA_COLOURED-BODY PORCELAIN STONEWARE

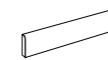









BATTISCOPA
10x60 cm Rect - 4"x24"
 10 mm
NATURALE

CHALET PGRDA001

CIASA PGRDA201

MASO PGRDA401

IMBALLAGGI E PESI_PACKINGS AND WEIGHTS

DESCRIZIONE Description	 mm	FORMATI Sizes	SCATOLA_Box				PALLET			
										
FONDO NATURALE	9,5	20x90,5	6	23,4	1,086	-	48	1123,2	52,128	
BATTISCOPA NATURALE	10	10x60 ^{RECT}	12	15	0,72	7,2	60	900	43,2	



Borealis



INARI



ABISKO



DONEGAL



ALTA

GRES PORCELLANATO A MASSA COLORATA_COLOURED-BODY PORCELAIN STONEWARE



± 10,5 mm
± 9,5 mm



30x180 cm Rect
12"x71"

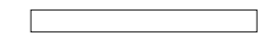

20x180 cm Rect
8"x71"

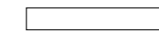

20x120 cm Rect
8"x48"

GRES PORCELLANATO A MASSA COLORATA_COLOURED-BODY PORCELAIN STONEWARE **20 mm**



± 20 mm



40x120 cm Rect
16"x48"



PAVIMENTO / FLOOR Abisko Naturale 20x120 cm Rect - 8"x48" _Abisko Strutturato 40x120 cm Rect - 16"x48" 20 mm



RIVESTIMENTO / WALL Chevron Inari Naturale 20x98 cm Rect - 8"x38"^{5/8}"
PAVIMENTO / FLOOR Inari Naturale 20x120 cm Rect - 8"x48"



PAVIMENTO / FLOOR Listello Inari Naturale 6,5x60 cm Rect - 2¹/₂"x24"



PAVIMENTO / FLOOR Donegal Naturale 20x180 cm Rect - 8"x71" _30x180 cm Rect - 12"x71"
Donegal Strutturato 40x120 cm Rect - 16"x48" 20 mm



PAVIMENTO / FLOOR Baroque Donegal Naturale 60x60 cm Rect - 24"x24"



RIVESTIMENTO / WALL Listello Alta Naturale 6,5x60 cm Rect - 2 1/2"x24"
PAVIMENTO / FLOOR Alta Naturale 30x180 cm Rect - 12"x71"

Borealis

PROTECT
ANTIBATTERICO - ANTIMICROBIAL

INARI



ABISKO



DONEGAL



ALTA



Borealis

GRES PORCELLANATO A MASSA COLORATA_COLOURED-BODY PORCELAIN STONEWARE

± 10,5 mm

30x180 cm Rect - 12"x71"

Inari NATURALE PGIBE301
Abisko NATURALE PGIBE001
Donegal NATURALE PGIBE201
Alta NATURALE PGIBE101

± 10,5 mm

20x180 cm Rect - 8"x71"

Inari NATURALE PG4BE30
Abisko NATURALE PG4BE00
Donegal NATURALE PG4BE20
Alta NATURALE PG4BE10

± 9,5 mm

20x120 cm Rect - 8"x48"

Inari NATURALE PGOBE301
Abisko NATURALE PGOBE001
Donegal NATURALE PGOBE201
Alta NATURALE PGOBE101
Inari EXT* PGOBE351
Abisko EXT* PGOBE051
Donegal EXT* PGOBE251
Alta EXT* PGOBE151

GRES PORCELLANATO A MASSA COLORATA_COLOURED-BODY PORCELAIN STONEWARE **20 mm**

± 20 mm

40x120 cm Rect - 16"x48"

Inari STRUTTURATO* PG9BE302
Abisko STRUTTURATO* PG9BE002
Donegal STRUTTURATO* PG9BE202
Alta STRUTTURATO* PG9BE102

DESTINAZIONI D'USO_INTENDED USE: NATURALE STRUTTURATO / EXT

DATI TECNICI_TECHNICAL DATA:

GRES PORCELLANATO A MASSA COLORATA COLOURED-BODY PORCELAIN STONEWARE		GRES PORCELLANATO A MASSA COLORATA COLOURED-BODY PORCELAIN STONEWARE	
±	10,5 / 9,5 mm		20 mm
	DIN EN 16165 - Annex B: R10 Naturale R11 Ext DIN EN 16165 - Annex A: C (A+B+C) Ext BCR TORTUS: $\mu > 0,40$ Naturale - Ext ANSI A326.3: ID - DCOF $\geq 0,42$ (dry) Naturale IW - DCOF $\geq 0,42$ (wet) Naturale IW+ Naturale* EW Ext AS/NZS 4586: P4 Ext BS 7976-2: PTV 36+WET (Sl.96 - Sl.55) Ext		DIN EN 16165 - Annex B: R11 Strutturato DIN EN 16165 - Annex A: C (A+B+C) Strutturato BCR TORTUS: $\mu > 0,40$ Strutturato ANSI A326.3: EW Strutturato AS/NZS 4586: P4 Strutturato BS 7976-2: PTV 36+WET (Sl.96 - Sl.55) Strutturato
	ANSI A137.1: V3 Naturale - Ext	ANSI A137.1:	V3 Strutturato
PROTECT ANTIBATTERICO - ANTIMICROBIAL	Naturale		

* Ad eccezione delle zone caratterizzate da un maggior rischio di scivolamento (come docce pubbliche, piscine coperte, ecc.) per le quali si consiglia una superficie Ext
With the exception of areas characterized by a higher risk of slipping (such as public showers, indoor swimming pools, etc.) for which a Ext surface is recommended

* Protezione antibatterica non presente_No antimicrobial protection_Der Antibakterielle Schutz nicht vorhanden_Protection antibactérienne pas présente

Borealis

DECORI_DECORS

GRES PORCELLANATO A MASSA COLORATA_COLOURED-BODY PORCELAIN STONWARE

INARI



BAROQUE NATURALE
60x60 cm Rect - 24"x24"
± 9,5 mm
PGWBE30

ABISKO



BAROQUE NATURALE
60x60 cm Rect - 24"x24"
± 9,5 mm
PGWBE00

DONEGAL



BAROQUE NATURALE
60x60 cm Rect - 24"x24"
± 9,5 mm
PGWBE20

ALTA



BAROQUE NATURALE
60x60 cm Rect - 24"x24"
± 9,5 mm
PGWBE10



PLANKS NATURALE
60x60 cm Rect - 24"x24"
± 9,5 mm
PGWBE80



PLANKS NATURALE
60x60 cm Rect - 24"x24"
± 9,5 mm
PGWBE50



PLANKS NATURALE
60x60 cm Rect - 24"x24"
± 9,5 mm
PGWBE70



CHEVRON NATURALE
20x98 cm Rect - 8"x38^{5/8"}
± 9,5 mm
PG2BE30



CHEVRON NATURALE
20x98 cm Rect - 8"x38^{5/8"}
± 9,5 mm
PG2BE00



CHEVRON NATURALE
20x98 cm Rect - 8"x38^{5/8"}
± 9,5 mm
PG2BE20



CHEVRON NATURALE
20x98 cm Rect - 8"x38^{5/8"}
± 9,5 mm
PG2BE10



LISTELLO NATURALE
6,5x60 cm Rect - 2^{1/2"}x24"
± 9,5 mm
PGTBE30



LISTELLO NATURALE
6,5x60 cm Rect - 2^{1/2"}x24"
± 9,5 mm
PGTBE00



LISTELLO NATURALE
6,5x60 cm Rect - 2^{1/2"}x24"
± 9,5 mm
PGTBE20



LISTELLO NATURALE
6,5x60 cm Rect - 2^{1/2"}x24"
± 9,5 mm
PGTBE10

Borealis

PEZZI SPECIALI_TRIM PIECES

GRES PORCELLANATO A MASSA COLORATA_COLOURED-BODY PORCELAIN STONWARE

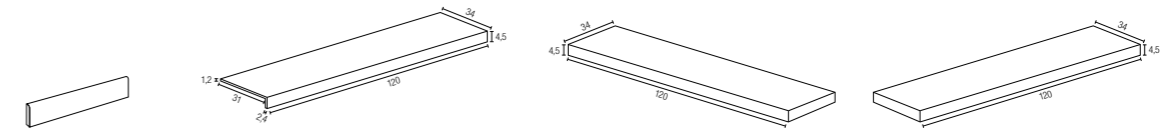

	BATTISCOPA 7,5x60 cm Rect - 3"x24" ± 10 mm NATURALE	GRADINO PLUS BORDO 34x120x4,5 cm Rect - 13 ^{3/8"} x48"x1 ^{3/4"} ± 9,5 mm NATURALE	GRADINO PLUS ANGOLARE DX 34x120x4,5 cm Rect - 13 ^{3/8"} x48"x1 ^{3/4"} ± 9,5 mm NATURALE	GRADINO PLUS ANGOLARE SX 34x120x4,5 cm Rect - 13 ^{3/8"} x48"x1 ^{3/4"} ± 9,5 mm NATURALE
INARI	PGRBE30	PGDBE30	PGDBE31	PGDBE32
ABISKO	PGRBE00	PGDBE00	PGDBE01	PGDBE02
DONEGAL	PGRBE20	PGDBE20	PGDBE21	PGDBE22
ALTA	PGRBE10	PGDBE10	PGDBE11	PGDBE12

GRES PORCELLANATO A MASSA COLORATA_COLOURED-BODY PORCELAIN STONWARE **20 mm**

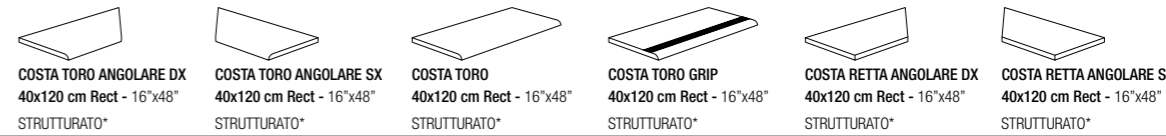

	COSTA TORO ANGOLARE DX 40x120 cm Rect - 16"x48" STRUTTURATO*	COSTA TORO ANGOLARE SX 40x120 cm Rect - 16"x48" STRUTTURATO*	COSTA TORO 40x120 cm Rect - 16"x48" STRUTTURATO*	COSTA TORO GRIP 40x120 cm Rect - 16"x48" STRUTTURATO*	COSTA RETTA ANGOLARE DX 40x120 cm Rect - 16"x48" STRUTTURATO*	COSTA RETTA ANGOLARE SX 40x120 cm Rect - 16"x48" STRUTTURATO*
INARI	PGDBEK3	PGDBEK7	PGDBEF3	PGDBEJ3	PGDBED3	PGDBED7
ABISKO	PGDBEK0	PGDBEK4	PGDBEF0	PGDBEJ0	PGDBED0	PGDBED4
DONEGAL	PGDBEK2	PGDBEK6	PGDBEF2	PGDBEJ2	PGDBED2	PGDBED6
ALTA	PGDBEK1	PGDBEK5	PGDBEF1	PGDBEJ1	PGDBED1	PGDBED5

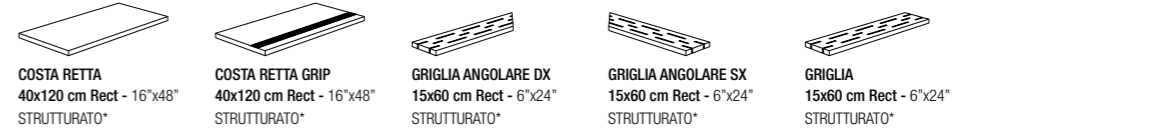

	COSTA RETTA 40x120 cm Rect - 16"x48" STRUTTURATO*	COSTA RETTA GRIP 40x120 cm Rect - 16"x48" STRUTTURATO*	GRIGLIA ANGOLARE DX 15x60 cm Rect - 6"x24" STRUTTURATO*	GRIGLIA ANGOLARE SX 15x60 cm Rect - 6"x24" STRUTTURATO*	GRIGLIA 15x60 cm Rect - 6"x24" STRUTTURATO*
INARI	PGDBEC3	PGDBEG3	PGDBEA6	PGDBEA7	PGDBEZ3
ABISKO	PGDBEC0	PGDBEG0	PGDBEA0	PGDBEA1	PGDBEZ0
DONEGAL	PGDBEC2	PGDBEG2	PGDBEA4	PGDBEA5	PGDBEZ2
ALTA	PGDBEC1	PGDBEG1	PGDBEA2	PGDBEA3	PGDBEZ1

* Protezione antibatterica non presente_No antimicrobial protection_Der Antibakterielle Schutz nicht vorhanden_Protection antibactérienne pas présente

IMBALLAGGI E PESI_PACKINGS AND WEIGHTS

DESCRIZIONE Description	± mm	FORMATI Sizes	SCATOLA_Box				PALLET		
				KG	M ²	ML		KG	M ²
FONDO NATURALE / EXT	9,5	20x120 ^{RECT}	6	30	1,44	-	24	720	34,56
FONDO NATURALE	10,5	20x180 ^{RECT}	3	25,5	1,08	-	48	1224	51,84
FONDO NATURALE	10,5	30x180 ^{RECT}	2	25,5	1,08	-	36	918	38,88
BAROQUE NATURALE	9,5	60x60 ^{RECT}	4	32	1,44	-	28	896	40,32
PLANKS NATURALE	9,5	60x60 ^{RECT}	4	31,8	1,44	-	32	1017,6	46,08
CHEVRON NATURALE	9,5	20x98 ^{RECT}	4	16	0,784	-	30	480	23,52
LISTELLO NATURALE	9,5	6,5x60 ^{RECT}	15	11	0,585	-	91	1001	53,235
BATTISCOPA NATURALE	10	7,5x60 ^{RECT}	12	11,61	0,54	7,2	60	696,6	32,4
GRADINO PLUS BORDO NATURALE	9,5	34x120x4,5 ^{RECT}	2	33,25	0,816	-	12	399	9,792
GRADINO PLUS ANGOLARE NATURALE	9,5	34x120x4,5 ^{RECT}	1	16,625	0,408	-	24	399	9,792
FONDO STRUTTURATO	20	40x120 ^{RECT}	2	43,5	0,96	-	24	1044	23,04
COSTA TORO STRUTTURATO	20	40x120 ^{RECT}	1	23	0,48	-	-	-	-
COSTA TORO ANGOLARE STRUTTURATO	20	40x120 ^{RECT}	1	21	0,4	-	-	-	-
COSTA TORO GRIP STRUTTURATO	20	40x120 ^{RECT}	1	23	0,48	-	-	-	-
COSTA RETTA STRUTTURATO	20	40x120 ^{RECT}	1	23	0,48	-	-	-	-
COSTA RETTA ANGOLARE STRUTTURATO	20	40x120 ^{RECT}	1	21	0,4	-	-	-	-
COSTA RETTA GRIP STRUTTURATO	20	40x120 ^{RECT}	1	23	0,48	-	-	-	-
GRIGLIA STRUTTURATO	20	15x60 ^{RECT}	2	8	0,18	-	100	800	18
GRIGLIA ANGOLARE STRUTTURATO	20	15x60 ^{RECT}	2	7	0,158	-	100	700	15,8



Cross Wood



BONE



BUFF



DUST

GRES PORCELLANATO A MASSA COLORATA_COLOURED-BODY PORCELAIN STONEWARE



± 9,5 mm

20x121,5 cm
8"x48"

GRES PORCELLANATO A MASSA COLORATA_COLOURED-BODY PORCELAIN STONEWARE **20 mm**



± 20 mm

30x120 cm Rect
12"x48"



PAVIMENTO / FLOOR Buff Naturale 20x121,5 cm - 8"x48"



PAVIMENTO / FLOOR Bone Naturale 20x121,5 cm - 8"x48"



PAVIMENTO / FLOOR Dust Strutturato 30x120 cm Rect - 12"x48" 20 mm

Cross Wood

BONE



BUFF



DUST



DESTINAZIONI D'USO_INTENDED USE: NATURALE STRUTTURATO

DATI TECNICI_TECHNICAL DATA:

GRES PORCELLANATO A MASSA COLORATA COLOURED-BODY PORCELAIN STONWARE		GRES PORCELLANATO A MASSA COLORATA COLOURED-BODY PORCELAIN STONWARE	
✚ 9,5 mm		20 mm	
DIN EN 16165 - Annex B: BCR TORTUS: ANSI A326.3:	R10 Naturale $\mu > 0,40$ Naturale ID - DCOF $\geq 0,42$ (dry) Naturale IW - DCOF $\geq 0,42$ (wet) Naturale	DIN EN 16165 - Annex B: BCR TORTUS: ANSI A326.3: AS/NZS 4586: UNE 41901 EX: BS 7976-2:	R11 Strutturato C (A+B+C) Strutturato $\mu > 0,40$ Strutturato EW Strutturato P4 Strutturato CLASE 3 Strutturato PTV 36+WET (SI.96 - SI.55) Strutturato
	ANSI A137.1: V2 Naturale (Bone) V3 Naturale (Buff-Dust)	ANSI A137.1:	V3 Strutturato (Buff-Dust)

Cross Wood

GRES PORCELLANATO A MASSA COLORATA_COLOURED-BODY PORCELAIN STONWARE



20x121,5 cm - 8"x48"

Bone NATURALE PG0CW001
Buff NATURALE PG0CW101
Dust NATURALE PG0CW401

GRES PORCELLANATO A MASSA COLORATA_COLOURED-BODY PORCELAIN STONWARE 20 mm

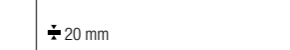

30x120 cm Rect - 12"x48"

Buff STRUTTURATO PG6CW101
Dust STRUTTURATO PG6CW401

PEZZI SPECIALI_TRIM PIECES

GRES PORCELLANATO A MASSA COLORATA_COLOURED-BODY PORCELAIN STONWARE

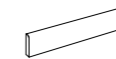

BATTISCOPA
10x60 cm Rect - 4"x24"
✚ 9,5 mm
NATURALE

BONE	PGRCW00A
BUFF	PGRCW10A
DUST	PGRCW40A

GRES PORCELLANATO A MASSA COLORATA_COLOURED-BODY PORCELAIN STONWARE 20 mm



COSTA TORO ANGOLARE DX
30x60 cm Rect - 12"x24"
STRUTTURATO

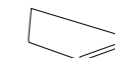

COSTA TORO ANGOLARE SX
30x60 cm Rect - 12"x24"
STRUTTURATO

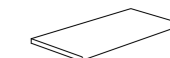

COSTA TORO
30x60 cm Rect - 12"x24"
STRUTTURATO



COSTA TORO GRIP
30x60 cm Rect - 12"x24"
STRUTTURATO



COSTA RETTA ANGOLARE DX
30x60 cm Rect - 12"x24"
STRUTTURATO

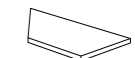

COSTA RETTA ANGOLARE SX
30x60 cm Rect - 12"x24"
STRUTTURATO

BUFF	PGDCWK1	PGDCWK6	PGDCWF1	PGDCWJ1	PGDCWD1	PGDCWD6
DUST	PGDCWK4	PGDCWK8	PGDCWF4	PGDCWJ4	PGDCWD4	PGDCWD8

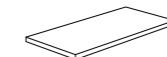

COSTA RETTA
30x60 cm Rect - 12"x24"
STRUTTURATO



COSTA RETTA GRIP
30x60 cm Rect - 12"x24"
STRUTTURATO

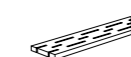

GRIGLIA ANGOLARE DX
15x60 cm Rect - 6"x24"
STRUTTURATO



GRIGLIA ANGOLARE SX
15x60 cm Rect - 6"x24"
STRUTTURATO

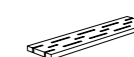

GRIGLIA
15x60 cm Rect - 6"x24"
STRUTTURATO

BUFF	PGDCWC1	PGDCWG1	PGDCWA1	PGDCWA6	PGDCWZ1
DUST	PGDCWC4	PGDCWG4	PGDCWA4	PGDCWA8	PGDCWZ4

IMBALLAGGI E PESI_PACKINGS AND WEIGHTS

DESCRIZIONE Description	✚ mm	FORMATI Sizes	SCATOLA_Box				PALLET		
FONDO NATURALE / EXT	9,5	20x121,5	6	32,28	1,458	-	24	774,72	34,992
BATTISCOPA NATURALE	9,5	10x60 ^{RECT}	12	15	0,72	7,2	60	900	43,2
FONDO STRUTTURATO	20	30x120 ^{RECT}	2	33,25	0,72	-	32	1064	23,04
COSTA TORO STRUTTURATO	20	30x60 ^{RECT}	1	8,125	0,135	-	100	812,5	13,5
COSTA TORO ANGOLARE STRUTTURATO	20	30x60 ^{RECT}	1	6,1	0,135	-	100	610	13,5
COSTA TORO GRIP STRUTTURATO	20	30x60 ^{RECT}	1	8,125	0,135	-	100	812,5	13,5
COSTA RETTA STRUTTURATO	20	30x60 ^{RECT}	1	8,125	0,135	-	100	812,5	13,5
COSTA RETTA ANGOLARE STRUTTURATO	20	30x60 ^{RECT}	1	6,1	0,135	-	100	610	13,5
COSTA RETTA GRIP STRUTTURATO	20	30x60 ^{RECT}	1	8,125	0,135	-	100	812,5	13,5
GRIGLIA STRUTTURATO	20	15x60 ^{RECT}	2	8	0,158	-	100	800	15,8
GRIGLIA ANGOLARE STRUTTURATO	20	15x60 ^{RECT}	2	7	0,158	-	100	700	15,8



Kairos



IMERA



ANEMOS

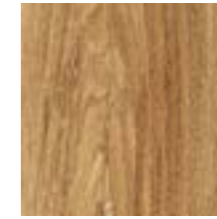

ILIOS

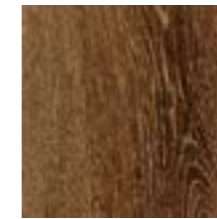

ZOI



STIGMI

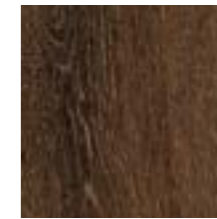

PATHOS

GRES PORCELLANATO A MASSA COLORATA_COLOURED-BODY PORCELAIN STONEWARE



± 9,5 mm



30x120 cm Rect
12"x48"



20x120 cm Rect
8"x48"



7,5x60 cm Rect
3"x24"

GRES PORCELLANATO A MASSA COLORATA_COLOURED-BODY PORCELAIN STONEWARE **20 mm**



± 20 mm



40x120 cm Rect
16"x48"



RIVESTIMENTO / WALL Imera Naturale 20x120 cm Rect - 8"x48" _Imera Ext 20x120 cm Rect - 8"x48" _Inserto Imera Naturale 20x120 cm Rect - 8"x48"
PAVIMENTO / FLOOR Wallcraft Wave 35x100 cm Rect - 13^{3/4}"x39" _Enigma Wax 35x100 cm Rect - 13^{3/4}"x39"



PAVIMENTO / FLOOR Zoi Strutturato 20 mm 40x120 cm Rect - 16"x48"



PAVIMENTO / FLOOR Listello Stigmi Naturale 7,5x60 cm Rect - 3"x24"



RIVESTIMENTO / WALL Esagono Pathos Naturale 32,7xh28,4 cm Rect - 12^{7/8}"x11^{1/8}"
PAVIMENTO / FLOOR Pathos Naturale 20x120 cm Rect - 8"x48"
TAVOLO / TABLE Stone Trace Crest Naturale



PAVIMENTO / FLOOR **Anemos Naturale 20x120 cm Rect - 8"x48"**_30x120 cm Rect - 12"x48"



RIVESTIMENTO / WALL **Blade Essence Naturale 100x300 cm Rect - 39"x118"**
PAVIMENTO / FLOOR **Stigmi Naturale 20x120 cm Rect - 8"x48"**



PAVIMENTO / FLOOR Zoi Naturale 20x120 cm Rect - 8"x48" _30x120 cm Rect - 12"x48"

IMERA



ANEMOS



ILIOS



ZOI

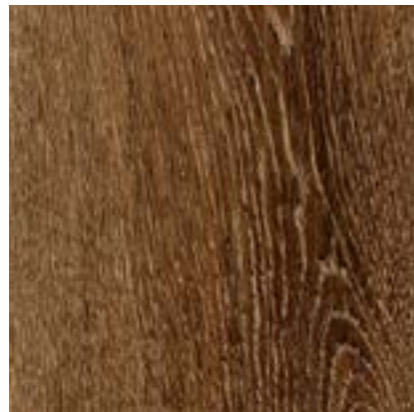

STIGMI



PATHOS



GRES PORCELLANATO A MASSA COLORATA_COLOURED-BODY PORCELAIN STONEWARE



30x120 cm Rect - 12"x48"

Ilios NATURALE	PG6KS00
Imera NATURALE	PG6KS10
Pathos NATURALE	PG6KS20
Stigmi NATURALE	PG6KS30
Zoi NATURALE	PG6KS40
Anemos NATURALE	PG6KS50



20x120 cm Rect - 8"x48"

Ilios NATURALE	PG0KS00
Imera NATURALE	PG0KS10
Pathos NATURALE	PG0KS20
Stigmi NATURALE	PG0KS30
Zoi NATURALE	PG0KS40
Anemos NATURALE	PG0KS75

Ilios EXT*	PG0KS05
Imera EXT*	PG0KS15
Pathos EXT*	PG0KS25
Stigmi EXT*	PG0KS35
Zoi EXT*	PG0KS45
Anemos EXT*	PG0KS65



7,5x60 cm Rect - 3"x24"

Ilios NATURALE	PGZKSL0
Imera NATURALE	PGZKSL1
Pathos NATURALE	PGZKSL2
Stigmi NATURALE	PGZKSL3
Zoi NATURALE	PGZKSL4
Anemos NATURALE	PGZKSL5

GRES PORCELLANATO A MASSA COLORATA_COLOURED-BODY PORCELAIN STONEWARE **20 mm**



40x120 cm Rect - 16"x48"

Ilios STRUTTURATO*	PG9KS001
Imera STRUTTURATO*	PG9KS101
Pathos STRUTTURATO*	PG9KS201
Stigmi STRUTTURATO*	PG9KS301
Zoi STRUTTURATO*	PG9KS401
Anemos STRUTTURATO*	PG9KS501

DESTINAZIONI D'USO_INTENDED USE: NATURALE STRUTTURATO / EXT

DATI TECNICI_TECHNICAL DATA:

GRES PORCELLANATO A MASSA COLORATA COLOURED-BODY PORCELAIN STONEWARE		GRES PORCELLANATO A MASSA COLORATA COLOURED-BODY PORCELAIN STONEWARE	
	9,5 mm		20 mm
DIN EN 16165 - Annex B:	R10 Naturale R11 Ext	DIN EN 16165 - Annex B:	R11 Strutturato
DIN EN 16165 - Annex A:	C (A+B+C) Ext	DIN EN 16165 - Annex A:	C (A+B+C) Strutturato
BCR TORTUS:	$\mu > 0,40$ Naturale - Ext	BCR TORTUS:	$\mu > 0,40$ Strutturato
ANSI A326.3:	ID - DCOF $\geq 0,42$ (dry) Naturale IW - DCOF $\geq 0,42$ (wet) Naturale IW+ Naturale* EW Ext	ANSI A326.3:	EW Strutturato
AS/NZS 4586:	P4 Ext	AS/NZS 4586:	P4 Strutturato
BS 7976-2:	PTV 36+WET (SI.96 - SI.55) Ext	BS 7976-2:	PTV 36+WET (SI.96 - SI.55) Strutturato
	ANSI A137.1:		ANSI A137.1:
	V3 Naturale - Ext (Imera-Anemos) V4 Naturale - Ext (Ilios-Zoi-Stigmi-Pathos)		V3 Strutturato (Imera-Anemos) V4 Strutturato (Ilios-Zoi-Stigmi-Pathos)
PROTECT ANTIBATTERICO - ANTIMICROBIAL	Naturale - Ext		

* Ad eccezione delle zone caratterizzate da un maggior rischio di scivolamento (come docce pubbliche, piscine coperte, ecc.) per le quali si consiglia una superficie Ext
With the exception of areas characterized by a higher risk of slipping (such as public showers, indoor swimming pools, etc.) for which a Ext surface is recommended

Kairos

DECORI_DECORS

GRES PORCELLANATO A MASSA COLORATA_COLOURED-BODY PORCELAIN STONWARE

IMERA



INSERTO NATURALE
20x120 cm Rect - 8"x48"
± 9,5 mm
PGZKS51

ZOI



INSERTO NATURALE
20x120 cm Rect - 8"x48"
± 9,5 mm
PGZKS54

ANEMOS



INSERTO NATURALE
20x120 cm Rect - 8"x48"
± 9,5 mm
PGZKS55

STIGMI



INSERTO NATURALE
20x120 cm Rect - 8"x48"
± 9,5 mm
PGZKS53

ILIOS



INSERTO NATURALE
20x120 cm Rect - 8"x48"
± 9,5 mm
PGZKS50

PATHOS



INSERTO NATURALE
20x120 cm Rect - 8"x48"
± 9,5 mm
PGZKS52

IMERA



ESAGONO NATURALE
32,7x28,4 cm Rect - 12^{7/8}"x11^{1/8}"
± 9,5 mm
PGZKS01

ZOI



ESAGONO NATURALE
32,7x28,4 cm Rect - 12^{7/8}"x11^{1/8}"
± 9,5 mm
PGZKS04

ANEMOS



ESAGONO NATURALE
32,7x28,4 cm Rect - 12^{7/8}"x11^{1/8}"
± 9,5 mm
PGZKS05

STIGMI



ESAGONO NATURALE
32,7x28,4 cm Rect - 12^{7/8}"x11^{1/8}"
± 9,5 mm
PGZKS03

ILIOS



ESAGONO NATURALE
32,7x28,4 cm Rect - 12^{7/8}"x11^{1/8}"
± 9,5 mm
PGZKS00

PATHOS



ESAGONO NATURALE
32,7x28,4 cm Rect - 12^{7/8}"x11^{1/8}"
± 9,5 mm
PGZKS02

Kairos

PEZZI SPECIALI_TRIM PIECES

GRES PORCELLANATO A MASSA COLORATA_COLOURED-BODY PORCELAIN STONWARE

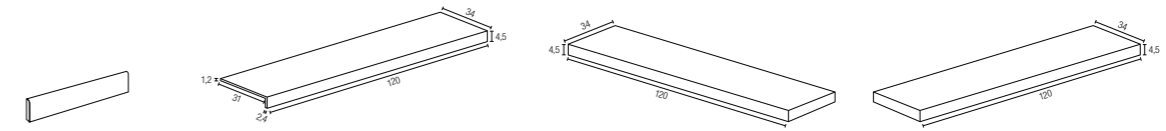

	BATTISCOPA 7,5x60 cm Rect - 3"x24" ± 9,5 mm NATURALE	GRADINO PLUS BORDO 34x120x4,5 cm Rect - 13 ^{3/8} "x48"x1 ^{3/4} " ± 9,5 mm NATURALE	GRADINO PLUS ANGOLARE DX 34x120x4,5 cm Rect - 13 ^{3/8} "x48"x1 ^{3/4} " ± 9,5 mm NATURALE	GRADINO PLUS ANGOLARE SX 34x120x4,5 cm Rect - 13 ^{3/8} "x48"x1 ^{3/4} " ± 9,5 mm NATURALE
ILIOS	PGRKS00	PGDKS00	PGDKS01	PGDKS02
IMERA	PGRKS10	PGDKS10	PGDKS11	PGDKS12
PATHOS	PGRKS20	PGDKS20	PGDKS21	PGDKS22
STIGMI	PGRKS30	PGDKS30	PGDKS31	PGDKS32
ZOI	PGRKS40	PGDKS40	PGDKS41	PGDKS42
ANEMOS	PGRKS50	PGDKS50	PGDKS51	PGDKS52

GRES PORCELLANATO A MASSA COLORATA_COLOURED-BODY PORCELAIN STONWARE **20 mm**

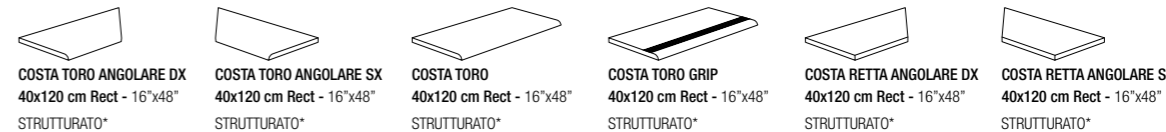

	COSTA TORO ANGOLARE DX 40x120 cm Rect - 16"x48" STRUTTURATO*	COSTA TORO ANGOLARE SX 40x120 cm Rect - 16"x48" STRUTTURATO*	COSTA TORO 40x120 cm Rect - 16"x48" STRUTTURATO*	COSTA TORO GRIP 40x120 cm Rect - 16"x48" STRUTTURATO*	COSTA RETTA ANGOLARE DX 40x120 cm Rect - 16"x48" STRUTTURATO*	COSTA RETTA ANGOLARE SX 40x120 cm Rect - 16"x48" STRUTTURATO*
ILIOS	PGDKSK0	PGDKSK1	PGDKSF0	PGDKSJ0	PGDKSD0	PGDKSD1
IMERA	PGDKSK2	PGDKSK3	PGDKSF1	PGDKSJ1	PGDKSD2	PGDKSD3
PATHOS	PGDKSK4	PGDKSK5	PGDKSF2	PGDKSJ2	PGDKSD4	PGDKSD5
STIGMI	PGDKSK6	PGDKSK7	PGDKSF3	PGDKSJ3	PGDKSD6	PGDKSD7
ZOI	PGDKSK8	PGDKSK9	PGDKSF4	PGDKSJ4	PGDKSD8	PGDKSD9
ANEMOS	PGDKSB3	PGDKSB4	PGDKSF5	PGDKSJ5	PGDKSB0	PGDKSB1

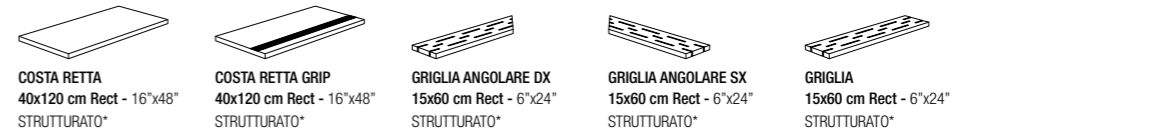

	COSTA RETTA 40x120 cm Rect - 16"x48" STRUTTURATO*	COSTA RETTA GRIP 40x120 cm Rect - 16"x48" STRUTTURATO*	GRIGLIA ANGOLARE DX 15x60 cm Rect - 6"x24" STRUTTURATO*	GRIGLIA ANGOLARE SX 15x60 cm Rect - 6"x24" STRUTTURATO*	GRIGLIA 15x60 cm Rect - 6"x24" STRUTTURATO*
ILIOS	PGDKSC0	PGDKSG0	PGDKSA0	PGDKSA1	PGDKSZ0
IMERA	PGDKSC1	PGDKSG1	PGDKSA2	PGDKSA3	PGDKSZ1
PATHOS	PGDKSC2	PGDKSG2	PGDKSA4	PGDKSA5	PGDKSZ2
STIGMI	PGDKSC3	PGDKSG3	PGDKSA6	PGDKSA7	PGDKSZ3
ZOI	PGDKSC4	PGDKSG4	PGDKSA8	PGDKSA9	PGDKSZ4
ANEMOS	PGDKSC5	PGDKSG5	PGDKSB5	PGDKSB6	PGDKSZ5

* Protezione antibatterica non presente_No antimicrobial protection_Der Antibakterielle Schutz nicht vorhanden_Protection antibactérienne pas présente

IMBALLAGGI E PESI_PACKINGS AND WEIGHTS

DESCRIZIONE Description	± mm	FORMATI Sizes	SCATOLA_Box				PALLET		
FONDO NATURALE / EXT	9,5	20x120 ^{RECT}	6	30	1,44	-	24	720	34,56
FONDO NATURALE	9,5	30x120 ^{RECT}	4	30,4	1,44	-	18	547,2	25,92
LISTELLO NATURALE	9,5	7,5x60 ^{RECT}	14	13	0,63	-	60	780	37,8
ESAGONO NATURALE	9,5	32,7x28,4 ^{RECT}	10	20,5	0,929	-	24	492	22,296
INSERTO NATURALE	9,5	20x120 ^{RECT}	4	21,1	0,96	-	24	506,4	23,04
GRADINO PLUS BORDO NATURALE	9,5	34x120x4,5 ^{RECT}	2	33,25	0,816	-	12	399	9,792
GRADINO PLUS ANGOLARE NATURALE	9,5	34x120x4,5 ^{RECT}	1	16,625	0,408	-	24	399	9,792
BATTISCOPA NATURALE	9,5	7,5x60 ^{RECT}	12	11,61	0,54	7,2	60	696,6	32,4
FONDO STRUTTURATO	20	40x120 ^{RECT}	2	43,5	0,96	-	24	1044	23,04
COSTA TORO STRUTTURATO	20	40x120 ^{RECT}	1	23	0,48	-	-	-	-
COSTA TORO ANGOLARE STRUTTURATO	20	40x120 ^{RECT}	1	21	0,4	-	-	-	-
COSTA TORO GRIP STRUTTURATO	20	40x120 ^{RECT}	1	23	0,48	-	-	-	-
COSTA RETTA STRUTTURATO	20	40x120 ^{RECT}	1	23	0,48	-	-	-	-
COSTA RETTA ANGOLARE STRUTTURATO	20	40x120 ^{RECT}	1	21	0,4	-	-	-	-
COSTA RETTA GRIP STRUTTURATO	20	40x120 ^{RECT}	1	23	0,48	-	-	-	-
GRIGLIA STRUTTURATO	20	15x60 ^{RECT}	2	8	0,18	-	100	800	18
GRIGLIA ANGOLARE STRUTTURATO	20	15x60 ^{RECT}	2	7	0,1575	-	100	700	15,75



Nuance



CARAMEL



MIEL

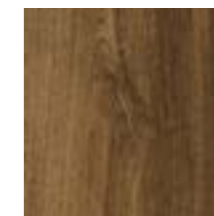

TABAC



CENDRE



PERLE

GRES PORCELLANATO A MASSA COLORATA_COLOURED-BODY PORCELAIN STONEWARE



± 10,5 mm
± 9,5 mm



30x180 cm Rect
12"x71"

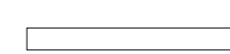

20x180 cm Rect
8"x71"



30x120 cm Rect
12"x48"



20x120 cm Rect
8"x48"

GRES PORCELLANATO A MASSA COLORATA_COLOURED-BODY PORCELAIN STONEWARE **20 mm**



± 20 mm

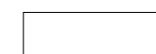

40x120 cm Rect
16"x48"



PAVIMENTO / FLOOR Caramel Naturale 30x180 cm Rect - 12"x71" _20x180 cm Rect - 8"x71"



PAVIMENTO / FLOOR Tabac Naturale 20x120 cm Rect - 8"x48" _Tabac Strutturato 20x120 cm Rect - 8"x48"



PAVIMENTO / FLOOR Listello Tabac Naturale 7x60 cm Rect - 2³/₄"x24" _ Quadrato Tabac Naturale 7x7 cm Rect - 2³/₄"x2³/₄"
Trilogy Calacatta White Lux 60x60 cm Rect - 24"x24"



PAVIMENTO / FLOOR Chevron Cendre Naturale 55x38 cm Rect - 21⁵/₈"x15"



RIVESTIMENTO / WALL Mosaïque Cendre Naturelle 30x30 cm Rect - 12"x12"
PAVIMENTO / FLOOR Perle Naturelle 20x180 cm Rect - 8"x71"

Nuance

PROTECT
ANTIBATTERICO - ANTIMICROBIAL

CARAMEL



MIEL



TABAC



CENDRE



PERLE



DESTINAZIONI D'USO_INTENDED USE: NATURALE STRUTTURATO

DATI TECNICI_TECHNICAL DATA:

GRES PORCELLANATO A MASSA COLORATA COLOURED-BODY PORCELAIN STONEWARE		GRES PORCELLANATO A MASSA COLORATA COLOURED-BODY PORCELAIN STONEWARE	
±	10,5 / 9,5 mm		20 mm
DIN EN 16165 - Annex B:	R10 Naturale R11 Strutturato	DIN EN 16165 - Annex B:	R11 Strutturato
DIN EN 16165 - Annex A:	C (A+B+C) Strutturato	DIN EN 16165 - Annex A:	C (A+B+C) Strutturato
BCR TORTUS:	μ > 0,40 Naturale - Strutturato	BCR TORTUS:	μ > 0,40 Strutturato
ANSI A326.3:	ID - DCOF ≥ 0.42 (dry) Naturale IW - DCOF ≥ 0.42 (wet) Naturale EW Strutturato	ANSI A326.3:	EW Strutturato
AS/NZS 4586:	P4 Strutturato	AS/NZS 4586:	P4 Strutturato
BS 7976-2:	PTV 36+WET (SI.96 - SI.55) Strutturato	BS 7976-2:	PTV 36+WET (SI.96 - SI.55) Strutturato
	ANSI A137.1: V3 Naturale - Strutturato		ANSI A137.1: V3 Strutturato
PROTECT ANTIBATTERICO - ANTIMICROBIAL	Naturale		

Nuance

GRES PORCELLANATO A MASSA COLORATA_COLOURED-BODY PORCELAIN STONEWARE



30x180 cm Rect - 12"x71"

Caramel NATURALE	PGIN1001
Miel NATURALE	PGIN1201
Tabac NATURALE	PGIN1401
Cendre NATURALE	PGIN1101
Perle NATURALE	PGIN1301



20x180 cm Rect - 8"x71"

Caramel NATURALE	PG4N100G
Miel NATURALE	PG4N120G
Tabac NATURALE	PG4N140G
Cendre NATURALE	PG4N110G
Perle NATURALE	PG4N130G

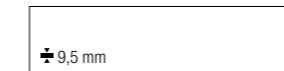

30x120 cm Rect - 12"x48"

Caramel NATURALE	PG6N100
Miel NATURALE	PG6N120
Tabac NATURALE	PG6N140
Cendre NATURALE	PG6N110
Perle NATURALE	PG6N130



20x120 cm Rect - 8"x48"

Caramel NATURALE	PGON1001
Miel NATURALE	PGON1201
Tabac NATURALE	PGON1401
Cendre NATURALE	PGON1101
Perle NATURALE	PGON1301
Caramel STRUTTURATO*	PGON1051
Miel STRUTTURATO*	PGON1251
Tabac STRUTTURATO*	PGON1451
Cendre STRUTTURATO*	PGON1151
Perle STRUTTURATO*	PGON1351

GRES PORCELLANATO A MASSA COLORATA_COLOURED-BODY PORCELAIN STONEWARE **20 mm**



40x120 cm Rect - 16"x48"

Caramel STRUTTURATO*	PG9N1002
Miel STRUTTURATO*	PG9N1202
Tabac STRUTTURATO*	PG9N1402

DECORI_DECORS

GRES PORCELLANATO A MASSA COLORATA_COLOURED-BODY PORCELAIN STONEWARE

CARAMEL



DÉCORATIF NATURALE
60x60 cm Rect - 24"x24"
± 9,5 mm
PGWN100

MIEL

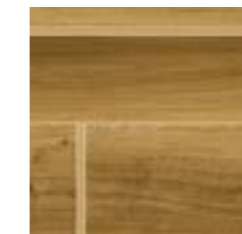

DÉCORATIF NATURALE
60x60 cm Rect - 24"x24"
± 9,5 mm
PGWN120

TABAC



DÉCORATIF NATURALE
60x60 cm Rect - 24"x24"
± 9,5 mm
PGWN140

CENDRE



DÉCORATIF NATURALE
60x60 cm Rect - 24"x24"
± 9,5 mm
PGWN110

PERLE



DÉCORATIF NATURALE
60x60 cm Rect - 24"x24"
± 9,5 mm
PGWN130



CHEVRON NATURALE
55x38 cm Rect - 21^{5/8}"x15"
± 9,5 mm
PGZN110



CHEVRON NATURALE
55x38 cm Rect - 21^{5/8}"x15"
± 9,5 mm
PGZN112



CHEVRON NATURALE
55x38 cm Rect - 21^{5/8}"x15"
± 9,5 mm
PGZN114



CHEVRON NATURALE
55x38 cm Rect - 21^{5/8}"x15"
± 9,5 mm
PGZN111



CHEVRON NATURALE
55x38 cm Rect - 21^{5/8}"x15"
± 9,5 mm
PGZN113

DÉCORATIF:

Posare solo a parete_Recommended only for wall applications_Nur an der Wand verlegen_Recommandé seulement pour les revêtements

* Protezione antibatterica non presente_No antimicrobial protection_Der Antibakterielle Schutz nicht vorhanden_Protection antibactérienne pas présente

Nuance

DECORI_DECORS

GRES PORCELLANATO A MASSA COLORATA_COLOURED-BODY PORCELAIN STONWARE

CARAMEL



MOSAIQUE NATURALE
30x30 cm Rect - 12"x12"
± 9,5 mm
PGZN120

MIEL



MOSAIQUE NATURALE
30x30 cm Rect - 12"x12"
± 9,5 mm
PGZN122

TABAC



MOSAIQUE NATURALE
30x30 cm Rect - 12"x12"
± 9,5 mm
PGZN124

CENDRE



MOSAIQUE NATURALE
30x30 cm Rect - 12"x12"
± 9,5 mm
PGZN121

PERLE



MOSAIQUE NATURALE
30x30 cm Rect - 12"x12"
± 9,5 mm
PGZN123



LISTELLO NATURALE
7x60 cm Rect - 2^{3/4}"x24"
± 9,5 mm
PGZN1L0



LISTELLO NATURALE
7x60 cm Rect - 2^{3/4}"x24"
± 9,5 mm
PGZN1L2



LISTELLO NATURALE
7x60 cm Rect - 2^{3/4}"x24"
± 9,5 mm
PGZN1L4



LISTELLO NATURALE
7x60 cm Rect - 2^{3/4}"x24"
± 9,5 mm
PGZN1L1



LISTELLO NATURALE
7x60 cm Rect - 2^{3/4}"x24"
± 9,5 mm
PGZN1L3



QUADRATO NATURALE
7x7 cm Rect - 2^{3/4}"x2^{3/4}"
± 9,5 mm
PGZN100



QUADRATO NATURALE
7x7 cm Rect - 2^{3/4}"x2^{3/4}"
± 9,5 mm
PGZN102



QUADRATO NATURALE
7x7 cm Rect - 2^{3/4}"x2^{3/4}"
± 9,5 mm
PGZN104



QUADRATO NATURALE
7x7 cm Rect - 2^{3/4}"x2^{3/4}"
± 9,5 mm
PGZN101



QUADRATO NATURALE
7x7 cm Rect - 2^{3/4}"x2^{3/4}"
± 9,5 mm
PGZN103

ESEMPI COMPOSIZIONI_TILE LAYOUT EXAMPLES



NUANCE LISTELLO Tabac Naturale
NUANCE QUADRATO Tabac Naturale
TRILOGY Calacatta White Lux 60x60 cm Rect



NUANCE LISTELLO Perle Naturale
NUANCE QUADRATO Cendre Naturale
TRILOGY Calacatta White Lux 60x60 cm Rect

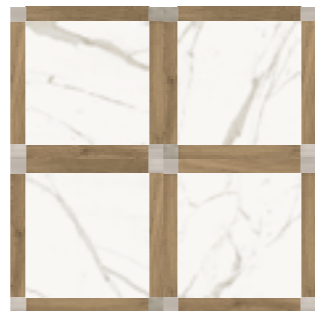

NUANCE LISTELLO Cendre Naturale
NUANCE QUADRATO Perle Naturale
TRILOGY Calacatta White Lux 60x60 cm Rect

Per questo tipo di posa Listello e Quadrato Nuance sono abbinabili tra loro e con tutti i fondi 60x60 rettificati delle collezioni a catalogo. For this laying solution Nuance Listello and Quadrato are matchable with the 60x60 rectified of all collections. Bei dieser Art von Verlegung sind Listello und Quadrato Nuance untereinander und mit allen begradtigten 60x60 Untergrunden der Katalogkollektionen kombinierbar. Pour ce type de pose Listello et Quadrato Nuance sont combinables entre eux et avec tous les fonds de 60x60 rectifiés des collections du catalogue.

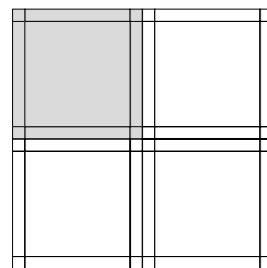

Modulo A_Modulo A_Modul A_Modulo A

4 PEZZI 7x60 (30,68%)
4 PEZZI 7x7 (3,58%)
1 PEZZO 60x60 (80,20%)

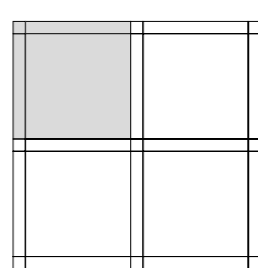

Modulo B_Modulo B_Modul B_Modulo B

2 PEZZI 7x60 (18,71%)
1 PEZZI 7x7 (1,09%)
1 PEZZO 60x60 (80,20%)

Nuance

PEZZI SPECIALI_TRIM PIECES

GRES PORCELLANATO A MASSA COLORATA_COLOURED-BODY PORCELAIN STONWARE

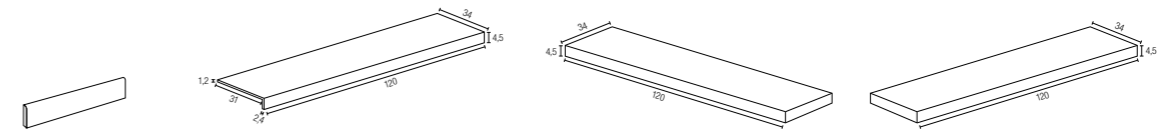

	BATTISCOPIA 7,5x60 cm Rect - 3"x24" ± 9,5 mm NATURALE	GRADINO PLUS BORDO 34x120x4,5 cm Rect - 13 ^{3/8} "x48"x1 ^{3/4} " ± 9,5 mm NATURALE	GRADINO PLUS ANGOLARE DX 34x120x4,5 cm Rect - 13 ^{3/8} "x48"x1 ^{3/4} " ± 9,5 mm NATURALE	GRADINO PLUS ANGOLARE SX 34x120x4,5 cm Rect - 13 ^{3/8} "x48"x1 ^{3/4} " ± 9,5 mm NATURALE
CARAMEL	PGRN150A	PGDN100	PGDN101	PGDN102
MIEL	PGRN170A	PGDN120	PGDN121	PGDN122
TABAC	PGRN190A	PGDN140	PGDN141	PGDN142
CENDRE	PGRN160A	PGDN110	PGDN111	PGDN112
PERLE	PGRN180A	PGDN130	PGDN131	PGDN132

GRES PORCELLANATO A MASSA COLORATA_COLOURED-BODY PORCELAIN STONWARE 20 mm

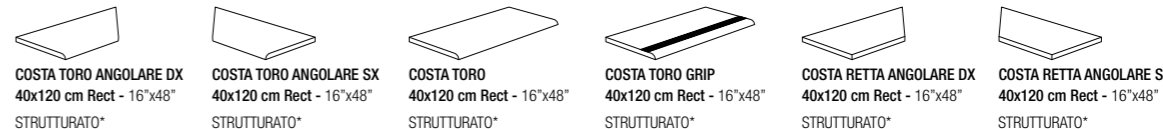

	COSTA TORO ANGOLARE DX 40x120 cm Rect - 16"x48" STRUTTURATO*	COSTA TORO ANGOLARE SX 40x120 cm Rect - 16"x48" STRUTTURATO*	COSTA TORO 40x120 cm Rect - 16"x48" STRUTTURATO*	COSTA TORO GRIP 40x120 cm Rect - 16"x48" STRUTTURATO*	COSTA RETTA ANGOLARE DX 40x120 cm Rect - 16"x48" STRUTTURATO*	COSTA RETTA ANGOLARE SX 40x120 cm Rect - 16"x48" STRUTTURATO*
CARAMEL	PGDN1K3	PGDN1K0	PGDN1F0	PGDN1J0	PGDN1D3	PGDN1D0
MIEL	PGDN1K4	PGDN1K1	PGDN1F2	PGDN1J2	PGDN1D4	PGDN1D1
TABAC	PGDN1K5	PGDN1K2	PGDN1F4	PGDN1J4	PGDN1D5	PGDN1D2

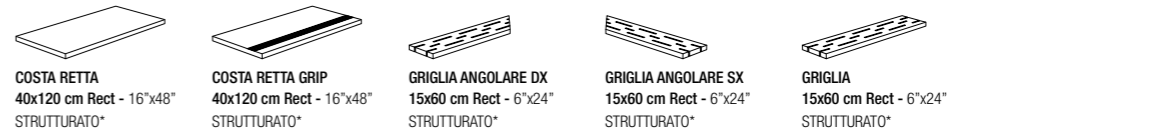

	COSTA RETTA 40x120 cm Rect - 16"x48" STRUTTURATO*	COSTA RETTA GRIP 40x120 cm Rect - 16"x48" STRUTTURATO*	GRIGLIA ANGOLARE DX 15x60 cm Rect - 6"x24" STRUTTURATO*	GRIGLIA ANGOLARE SX 15x60 cm Rect - 6"x24" STRUTTURATO*	GRIGLIA 15x60 cm Rect - 6"x24" STRUTTURATO*
CARAMEL	PGDN1C0	PGDN1G0	PGDN1A3	PGDN1A0	PGDN1Z0
MIEL	PGDN1C2	PGDN1G2	PGDN1A4	PGDN1A1	PGDN1Z2
TABAC	PGDN1C4	PGDN1G4	PGDN1A5	PGDN1A2	PGDN1Z4

* Protezione antibatterica non presente_No antimicrobial protection_Der Antibakterielle Schutz nicht vorhanden_Protection antibactérienne pas présente

IMBALLAGGI E PESI_PACKINGS AND WEIGHTS

DESCRIZIONE Description	± mm	FORMATI Sizes	SCATOLA_Box				PALLET		
			📦	📊	📏	📏	📦	📊	📏
FONDO NATURALE / STRUTTURATO	9,5	20x120 ^{RECT}	6	30	1,44	-	24	720	34,56
FONDO NATURALE	9,5	30x120 ^{RECT}	4	30,4	1,44	-	18	547,2	25,92
FONDO NATURALE	10,5	20x180 ^{RECT}	3	25,5	1,08	-	48	1224	51,84
FONDO NATURALE	10,5	30x180 ^{RECT}	2	25,5	1,08	-	36	918	38,88
DÉCORATIF NATURALE	9,5	60x60 ^{RECT}	2	15,25	0,72	-	30	457,5	21,6
CHEVRON NATURALE	9,5	55x38 ^{RECT}	4	17,1	0,836	-	24	410,4	20,06
MOSAIQUE NATURALE	9,5	30x30 ^{RECT}	6	11,1	0,54	-	42	466,83	22,68
LISTELLO NATURALE	9,5	7x60 ^{RECT}	16	13,77	0,672	-	40	551	26,88
QUADRATO NATURALE	9,5	7x7 ^{RECT}	16	1,615	0,078	-	456	736,44	35,8
GRADINO PLUS BORDO NATURALE	9,5	34x120x4,5 ^{RECT}	2	33,25	0,816	-	12	399	9,8
GRADINO PLUS ANGOLARE NATURALE	9,5	34x120x4,5 ^{RECT}	1	16,62	0,408	-	24	399	9,79
BATTISCOPIA NATURALE	9,5	7,5x60 ^{RECT}	12	11,61	0,54	7,2	60	696,6	32,4
FONDO STRUTTURATO	20	40x120 ^{RECT}	2	43,5	0,96	-	24	1044	23,04
COSTA TORO STRUTTURATO	20	40x120 ^{RECT}	1	23	0,48	-	-	-	-
COSTA TORO ANGOLARE STRUTTURATO	20	40x120 ^{RECT}	1	21	0,4	-	-	-	-
COSTA TORO GRIP STRUTTURATO	20	40x120 ^{RECT}	1	23	0,48	-	-	-	-
COSTA RETTA STRUTTURATO	20	40x120 ^{RECT}	1	23	0,48	-	-	-	-
COSTA RETTA ANGOLARE STRUTTURATO	20	40x120 ^{RECT}	1	21	0,4	-	-	-	-
COSTA RETTA GRIP STRUTTURATO	20	40x120 ^{RECT}	1	23	0,48	-	-	-	-
GRIGLIA STRUTTURATO	20	15x60 ^{RECT}	2	8	0,18	-	100	800	18
GRIGLIA ANGOLARE STRUTTURATO	20	15x60 ^{RECT}	2	7	0,1575	-	100	700	15,75



Effetto cromatico



Chromatic look_Chromatischer Effekt_
Effet chromatique



Blade



OXIDE



CHROME



ESSENCE



RUST



PETROL

GRES PORCELLANATO LAMINATO / LAMINATED PORCELAIN STONEWARE **Zero.3**



± 3,5 mm

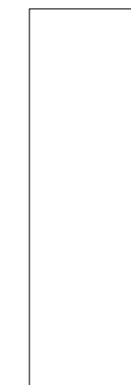

100x300 cm Rect
39"x118"

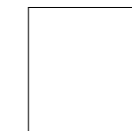

100x100 cm Rect
39"x39"



50x100 cm Rect
19 1/2"x39"



RIVESTIMENTO / WALL Chrome Naturale 100x300 cm Rect - 39"x118"
PAVIMENTO / FLOOR Chrome Naturale 100x100 cm Rect - 39"x39"



RIVESTIMENTO / WALL Essence Naturale 100x300 cm Rect - 39"x118" _Katana Essence 50x100 cm Rect - 19 1/2"x39"
Oxide Naturale 100x300 cm Rect - 39"x118" _50x100 cm Rect - 19 1/2"x39"
PAVIMENTO / FLOOR Oxide Naturale 100x100 cm Rect - 39"x39"



RIVESTIMENTO / WALL Katana Chrome 50x100 cm Rect - 19 1/2"x39"



RIVESTIMENTO / WALL Rust Naturale 100x300 cm Rect - 39"x118" _50x100 cm Rect - 19 1/2"x39" _Petrol Naturale 100x300 cm Rect - 39"x118"
 PAVIMENTO / FLOOR Rust Naturale 100x100 cm Rect - 39"x39"
 ARREDO / FURNITURE Rust Naturale_Petrol Naturale



RIVESTIMENTO / WALL Petrol Naturale 50x100 cm Rect - 19 1/2"x39" _Inlay Petrol 50x100 cm Rect - 19 1/2"x39"
 PAVIMENTO / FLOOR Rust Naturale 100x100 cm Rect - 39"x39"



RIVESTIMENTO / WALL Essence Naturale 50x100 cm Rect - 19 1/2"x39"

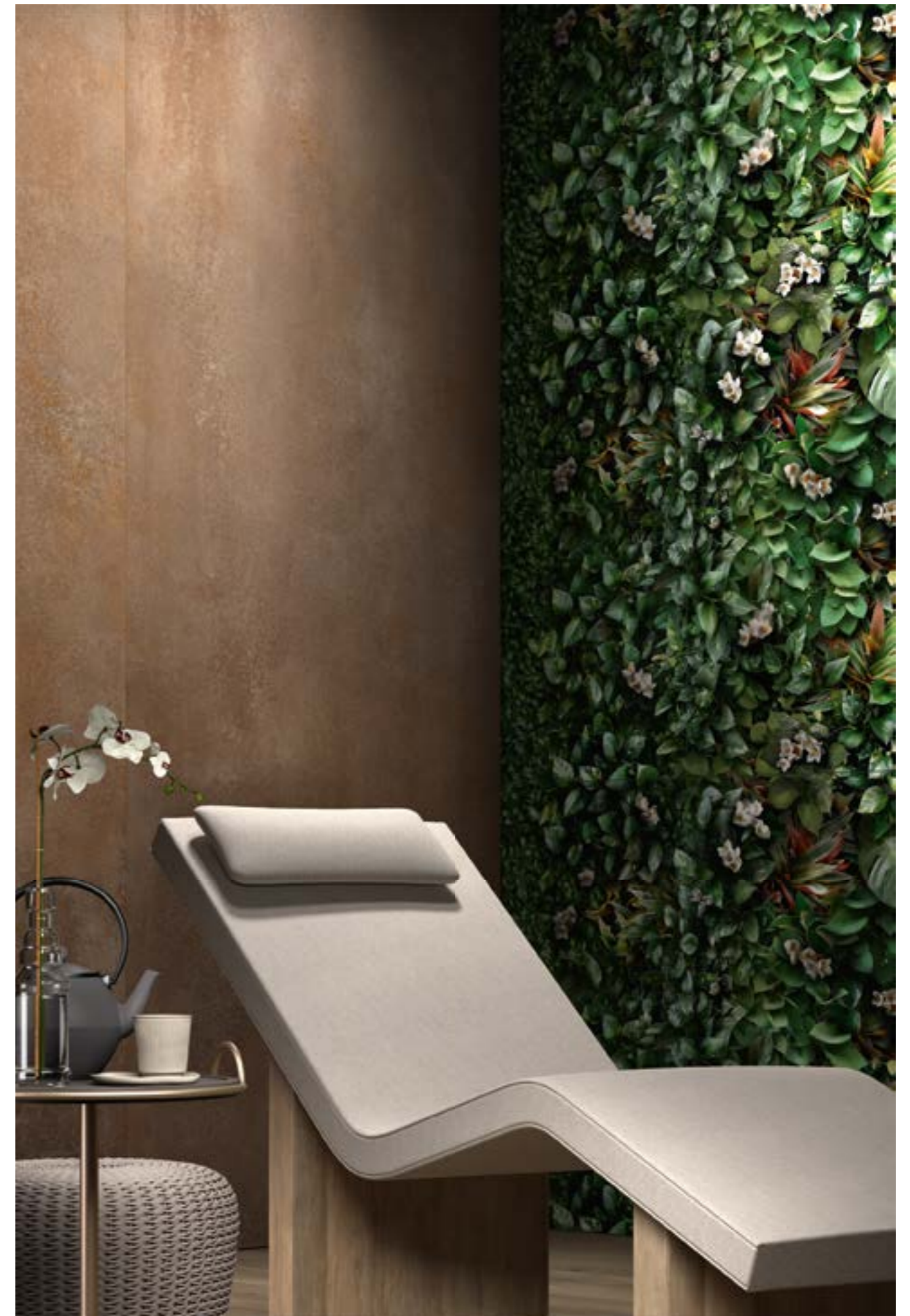

RIVESTIMENTO / WALL Rust Naturale 100x300 cm Rect - 39"x118" _Glam Greenwall 50x100 cm Rect - 19 1/2"x39"

Blade

P R () T E C T
ANTIBATTERICO - ANTIMICROBIAL

OXIDE



CHROME



ESSENCE



RUST



PETROL



Blade

GRES PORCELLANATO LAMINATO_LAMINATED PORCELAIN STONEWARE **Zero.3**



± 3,5 mm

100x300 cm Rect - 39"x118"
Oxide NATURALE PZ7BL10
Chrome NATURALE PZ7BL00
Essence NATURALE PZ7BL40
Rust NATURALE PZ7BL30
Petrol NATURALE PZ7BL20

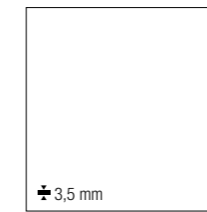



± 3,5 mm

100x100 cm Rect - 39"x39"
Oxide NATURALE PZ8BL10
Chrome NATURALE PZ8BL00
Essence NATURALE PZ8BL40
Rust NATURALE PZ8BL30
Petrol NATURALE PZ8BL20



± 3,5 mm

50x100 cm Rect - 19 1/2"x39"
Oxide NATURALE PZ9BL10
Chrome NATURALE PZ9BL00
Essence NATURALE PZ9BL40
Rust NATURALE PZ9BL30
Petrol NATURALE PZ9BL20

DESTINAZIONI D'USO_INTENDED USE: NATURALE  

DATI TECNICI_TECHNICAL DATA:

GRES PORCELLANATO LAMINATO
LAMINATED PORCELAIN STONEWARE

± 3,5 mm

 ANSI A326.3: ID - DCOF ≥ 0.42 (dry) Naturale

 ANSI A137.3: V2 Naturale (Oxide - Chrome)
V3 Naturale (Essence - Rust - Petrol)

P R () T E C T
ANTIBATTERICO - ANTIMICROBIAL Naturale

Blade

DECORI_DECORS

GRES PORCELLANATO LAMINATO_LAMINATED PORCELAIN STONEWARE **Zero.3**



HIVE OXIDE
100x300 cm Rect - 39"x118"
✚ 3,5 mm
PZ7BL60



HIVE CHROME
100x300 cm Rect - 39"x118"
✚ 3,5 mm
PZ7BL50



HIVE ESSENCE
100x300 cm Rect - 39"x118"
✚ 3,5 mm
PZ7BL90

Blade

DECORI_DECORS

GRES PORCELLANATO LAMINATO_LAMINATED PORCELAIN STONEWARE **Zero.3**



HIVE RUST
100x300 cm Rect - 39"x118"
✚ 3,5 mm
PZ7BL80



HIVE PETROL
100x300 cm Rect - 39"x118"
✚ 3,5 mm
PZ7BL70



HIVE OXIDE
50x100 cm Rect - 19 1/2"x39"
✚ 3,5 mm
PZ9BL60



HIVE CHROME
50x100 cm Rect - 19 1/2"x39"
✚ 3,5 mm
PZ9BL50



HIVE ESSENCE
50x100 cm Rect - 19 1/2"x39"
✚ 3,5 mm
PZ9BL90



HIVE RUST
50x100 cm Rect - 19 1/2"x39"
✚ 3,5 mm
PZ9BL80



HIVE PETROL
50x100 cm Rect - 19 1/2"x39"
✚ 3,5 mm
PZ9BL70



KATANA OXIDE
50x100 cm Rect - 19 1/2"x39"
✚ 3,5 mm
PZ9BLK1



KATANA CHROME
50x100 cm Rect - 19 1/2"x39"
✚ 3,5 mm
PZ9BLK0



KATANA ESSENCE
50x100 cm Rect - 19 1/2"x39"
✚ 3,5 mm
PZ9BLK4



KATANA RUST
50x100 cm Rect - 19 1/2"x39"
✚ 3,5 mm
PZ9BLK3



KATANA PETROL
50x100 cm Rect - 19 1/2"x39"
✚ 3,5 mm
PZ9BLK2

HIVE, KATANA:
Posare solo a parete_Recommended only for wall applications_Nur an der Wand verlegen_Recommandé seulement pour les revêtements
Protezione antibatterica non presente_No antimicrobial protection_Der Antibakterielle Schutz nicht vorhanden_Protection antibactérienne pas présente

HIVE, KATANA:
Posare solo a parete_Recommended only for wall applications_Nur an der Wand verlegen_Recommandé seulement pour les revêtements
Protezione antibatterica non presente_No antimicrobial protection_Der Antibakterielle Schutz nicht vorhanden_Protection antibactérienne pas présente

Blade

DECORI_DECORS

GRES PORCELLANATO LAMINATO_LAMINATED PORCELAIN STONEWARE **Zero.3**



INLAY OXIDE
50x100 cm Rect - 19 1/2"x39"
± 3,5 mm



INLAY CHROME
50x100 cm Rect - 19 1/2"x39"
± 3,5 mm



INLAY ESSENCE
50x100 cm Rect - 19 1/2"x39"
± 3,5 mm



INLAY RUST
50x100 cm Rect - 19 1/2"x39"
± 3,5 mm



INLAY PETROL
50x100 cm Rect - 19 1/2"x39"
± 3,5 mm

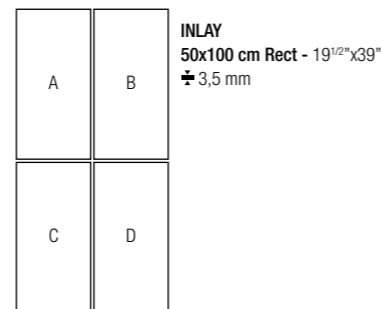

4 Moduli_4 Modules_4 Mustern_4 Modules A+B+C+D

Composizione 4 pz_4 Pieces composition_
Zusammensetzung 4 Stück_Composition 4 pièces

Posare solo a parete_Recommended only for wall applications_Nur an der Wand verlegen_Recommandé seulement pour les revêtements

Protezione antibatterica non presente_No antimicrobial protection_Der Antibakterielle Schutz nicht vorhanden_Protection antibactérienne pas présente

Inlay Oxide A	PZ9BL1A	Inlay Rust A	PZ9BL3A
Inlay Oxide B	PZ9BL1B	Inlay Rust B	PZ9BL3B
Inlay Oxide C	PZ9BL1C	Inlay Rust C	PZ9BL3C
Inlay Oxide D	PZ9BL1D	Inlay Rust D	PZ9BL3D
Inlay Chrome A	PZ9BL0A	Inlay Petrol A	PZ9BL2A
Inlay Chrome B	PZ9BL0B	Inlay Petrol B	PZ9BL2B
Inlay Chrome C	PZ9BL0C	Inlay Petrol C	PZ9BL2C
Inlay Chrome D	PZ9BL0D	Inlay Petrol D	PZ9BL2D
Inlay Essence A	PZ9BL4A		
Inlay Essence B	PZ9BL4B		
Inlay Essence C	PZ9BL4C		
Inlay Essence D	PZ9BL4D		

Blade

DECORI_DECORS

GRES PORCELLANATO LAMINATO_LAMINATED PORCELAIN STONEWARE **Zero.3**

HIVE, KATANA, INLAY:

Rivestimenti decorati da interno_Interior decorated wall coverings_Dekorierete Wandbelege für Innenbereich_Décor pour revêtement mural intérieur

I decori sono realizzati mediante la tecnologia di stampa digitale a freddo, che permette di raggiungere risultati estetici e cromatici di eccezionale qualità. Le grafiche vengono impresse ad altissima risoluzione sul supporto ceramico, mantenendo invariati i colori brillanti e le sfumature dei motivi decorativi_Decors are made using digital cold printing technology, with which aesthetic, chromatic results of exceptional quality are achieved. The graphics are printed at very high resolution on the ceramic substrate, keeping the brilliant colors and shades of the decorative designs unaltered_Die Dekore werden mit der kalten Digitaldrucktechnologie hergestellt, die es ermöglicht, ästhetische und chromatische Ergebnisse von außergewöhnlicher Qualität zu erzielen. Die Grafiken werden in sehr hoher Auflösung auf den Keramikträger gedruckt, wobei die brillanten Farben und Schattierungen der dekorativen Motive unverändert bleiben_Les décors sont réalisés grâce à la technologie d'impression numérique à froid, qui permet d'obtenir des résultats esthétiques et chromatiques d'une qualité exceptionnelle. Les graphismes sont imprimés en haute résolution sur le support céramique, en préservant la brillance des couleurs et les nuances des motifs décoratifs

Attenzione: per la pulizia dei decori attenersi scrupolosamente alle istruzioni riportate a pagina 415_Notice: for decors cleaning you should follow carefully the instructions provided on page 415_Achtung: für die Reinigung sich genau auf die Anleitungen auf der Seite 415 halten_Attention: pour le nettoyage des décors il faut suivre scrupuleusement les renseignements contenus à page 415

IMBALLAGGI E PESI_PACKINGS AND WEIGHTS

DESCRIZIONE Description	± mm	FORMATI Sizes	SCATOLA_Box				PALLET		
FONDO NATURALE	3,5	100x300 ^{RECT}	1	23,4	3	-	20	468	60
FONDO NATURALE	3,5	100x100 ^{RECT}	3	23,4	3	-	25	585	75
FONDO NATURALE	3,5	50x100 ^{RECT}	5	19,5	2,5	-	32	624	80
HIVE	3,5	100x300 ^{RECT}	1	23,4	3	-	20	468	60
HIVE	3,5	50x100 ^{RECT}	2	7,8	1	-	25	195	25
INLAY	3,5	50x100 ^{RECT}	2	7,8	1	-	25	195	25
KATANA	3,5	50x100 ^{RECT}	2	7,8	1	-	25	195	25

INLAY:

ogni scatola contiene due pezzi dello stesso modulo_each box contains two pieces of the same module_jedes Paket enthält 2 Stück von demselben Muster_chaque boîte contient deux pièces du même module



Even



SNOW



IVORY



DOVE

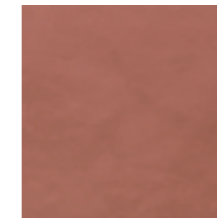

CHERRY

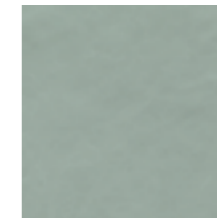

LEAF

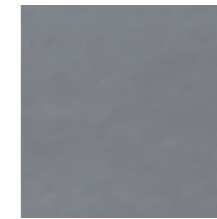

OCEAN

MONOPOROSA IN PASTA BIANCA SMALTATA - GLAZED WHITE BODY POROUS SINGLE-FIRED WALL TILES



± 8 mm



35x100 cm Rect
13^{3/4}"x39"



RIVESTIMENTO / WALL Cherry 35x100 cm Rect - 13^{3/4}"x39" _Geometric Warm 35x35 cm Rect - 13^{3/4}"x13^{3/4}" _Shapes Snow 35x100 cm Rect - 13^{3/4}"x39"
PAVIMENTO / FLOOR Context Loft Naturale 60x60 cm Rect - 24"x24"



RIVESTIMENTO / WALL Optical 35x100 cm Rect - 13^{3/4}"x39"

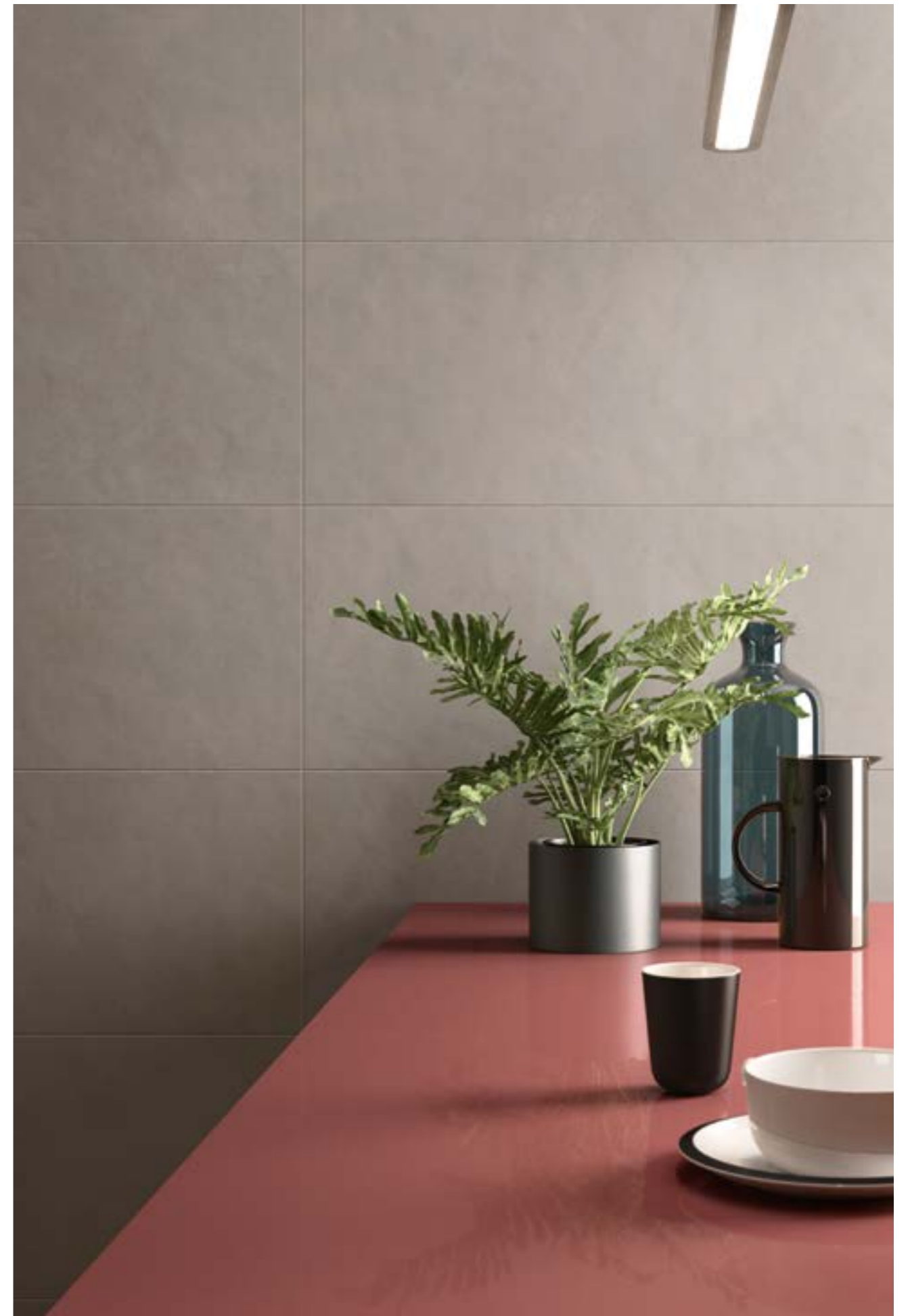

RIVESTIMENTO / WALL Dove 35x100 cm Rect - 13^{3/4}"x39"



RIVESTIMENTO / WALL Shapes Snow 35x100 cm Rect - 13^{3/4}"x39" _Medley Cold 35x100 cm Rect - 13^{3/4}"x39"



RIVESTIMENTO / WALL Leaf 35x100 cm Rect - 13^{3/4}"x39" _Shapes Ivory 35x100 cm Rect - 13^{3/4}"x39"



RIVESTIMENTO / WALL Ocean 35x100 cm Rect - 13^{3/4}"x39" _Shapes Ocean 35x100 cm Rect - 13^{3/4}"x39"
PAVIMENTO / FLOOR Context Hangar Naturale 90x90 cm Rect - 36"x36"

Even

SNOW



IVORY



DOVE



CHERRY



LEAF



OCEAN

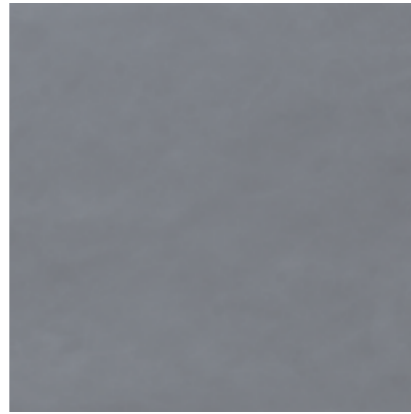

DATI TECNICI / TECHNICAL DATA:

MONOPOROSA IN PASTA BIANCA SMALTATA
GLAZED WHITE BODY POROUS SINGLE-FIRED WALL TILES

± 8 mm

ANSI A137.1: V1

Even

MONOPOROSA IN PASTA BIANCA SMALTATA / GLAZED WHITE BODY POROUS SINGLE-FIRED WALL TILES



35x100 cm Rect - 13^{3/4}"x39"

Snow PBF50S
Ivory PBF20S
Dove PBF10S
Cherry PBF00S
Leaf PBF30S
Ocean PBF40S

DECORI / DECORS

MONOPOROSA IN PASTA BIANCA SMALTATA / GLAZED WHITE BODY POROUS SINGLE-FIRED WALL TILES



FRAMEWORK
35x100 cm Rect - 13^{3/4}"x39"
± 8 mm
PBF50S



OPTICAL
35x100 cm Rect - 13^{3/4}"x39"
± 8 mm
PBF50S



MEDLEY COLD
35x100 cm Rect - 13^{3/4}"x39"
± 8 mm
PBF50S



MEDLEY WARM
35x100 cm Rect - 13^{3/4}"x39"
± 8 mm
PBF50S



MEDLEY MIX
35x100 cm Rect - 13^{3/4}"x39"
± 8 mm
PBF50S

MEDLEY:

Sviluppato su 6 soggetti / Developed on 6 patterns / Entwickelt auf 6 Bilder / Développé sur 6 éléments

FRAMEWORK:

Sviluppato su 4 soggetti / Developed on 4 patterns / Entwickelt auf 4 Bilder / Développé sur 4 éléments

MEDLEY - FRAMEWORK:

I soggetti all'interno della scatola sono presenti in modo casuale / The patterns are placed in the box randomly / Die Dekor-Bilder sind zufällig eingepackt / Les sujets à l'intérieur de la boîte sont présent de façon casuelle

Even

DECORI_DECORS

MONOPOROSA IN PASTA BIANCA SMALTATA_GLAZED WHITE BODY POROUS SINGLE-FIRED WALL TILES

SNOW



SHAPES
35x100 cm Rect - 13^{3/4}"x39"
± 9,5 mm
PBFEVS5S



MOSAICO
20x20 cm Rect - 8"x8"
± 8 mm
PBEEV50S

IVORY



SHAPES
35x100 cm Rect - 13^{3/4}"x39"
± 9,5 mm
PBFEVS2S



MOSAICO
20x20 cm Rect - 8"x8"
± 8 mm
PBEEV20S

DOVE



SHAPES
35x100 cm Rect - 13^{3/4}"x39"
± 9,5 mm
PBFEVS1S



MOSAICO
20x20 cm Rect - 8"x8"
± 8 mm
PBEEV10S

CHERRY



SHAPES
35x100 cm Rect - 13^{3/4}"x39"
± 9,5 mm
PBFEVS0S



MOSAICO
20x20 cm Rect - 8"x8"
± 8 mm
PBEEV00S

Even

DECORI_DECORS

MONOPOROSA IN PASTA BIANCA SMALTATA_GLAZED WHITE BODY POROUS SINGLE-FIRED WALL TILES

LEAF



SHAPES
35x100 cm Rect - 13^{3/4}"x39"
± 9,5 mm
PBFEVS3S

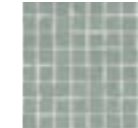

MOSAICO
20x20 cm Rect - 8"x8"
± 8 mm
PBEEV30S

OCEAN



SHAPES
35x100 cm Rect - 13^{3/4}"x39"
± 9,5 mm
PBFEVS4S

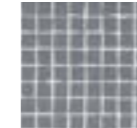

MOSAICO
20x20 cm Rect - 8"x8"
± 8 mm
PBEEV40S



GEOMETRIC WARM
35x35 cm Rect - 13^{3/4}"x13^{3/4}"
± 8 mm
PBCEVG1S



GEOMETRIC COLD
35x35 cm Rect - 13^{3/4}"x13^{3/4}"
± 8 mm
PBCEVG0S

IMBALLAGGI E PESI_PACKINGS AND WEIGHTS

DESCRIZIONE Description	± mm	FORMATI Sizes	SCATOLA_Box				PALLET		
FONDO	8	35x100 ^{RECT}	4	20,4	1,4	-	26	530,4	36,4
SHAPES	9,5	35x100 ^{RECT}	3	19,43	1,05	-	26	505,18	27,3
MEDLEY COLD	8	35x100 ^{RECT}	4	20,4	1,4	-	26	530,4	36,4
MEDLEY WARM	8	35x100 ^{RECT}	4	20,4	1,4	-	26	530,4	36,4
MEDLEY MIX	8	35x100 ^{RECT}	4	20,4	1,4	-	26	530,4	36,4
FRAMEWORK	8	35x100 ^{RECT}	4	20,4	1,4	-	26	530,4	36,4
OPTICAL	8	35x100 ^{RECT}	3	15	1,05	-	12	180	12,6
GEOMETRIC COLD	8	35x35 ^{RECT}	5	11,8	0,6125	-	60	708	36,75
GEOMETRIC WARM	8	35x35 ^{RECT}	5	11,8	0,6125	-	60	708	36,75
MOSAICO	8	20x20 ^{RECT}	11	4,5	0,44	-	90	405	39,6



RIVESTIMENTO / WALL Mistic 50x100 cm Rect - 19 1/2" x 39"

Glam

GRES PORCELLANATO LAMINATO
LAMINATED PORCELAIN STONEWARE **Zero.3**



RIVESTIMENTI DECORATI DA INTERNO
INTERIOR DECORATED WALL COVERINGS
± 3,5 mm

50x100 cm Rect - 19 1/2" x 39"



MISTIC A+B

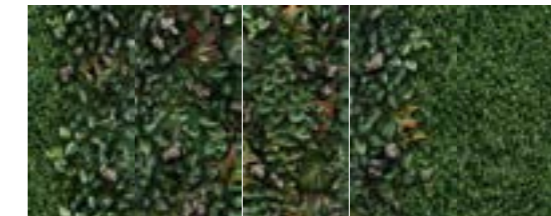

GREENWALL A+B+C+D+E



RAINFOREST A+B



COLORFUL A+B+C+D+E



HEDGE A+B



RELIC A+B



TARTAN MAUVE



TARTAN BEIGE



BOISERIE MAUVE



BOISERIE BEIGE



SHAPES A+B+C+D+E



WASHI

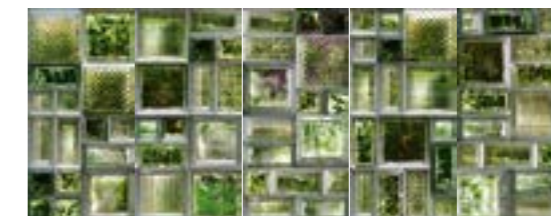

REFLEX A+B+C+D+E



VIBES A+B+C+D



RIVESTIMENTO / WALL Greenwall 50x100 cm Rect - 19 1/2"x39"



RIVESTIMENTO / WALL Rainforest 50x100 cm Rect - 19 1/2"x39"



RIVESTIMENTO / WALL Colorful 50x100 cm Rect - 19 1/2"x39"
PAVIMENTO / FLOOR Borealis Inari Naturale 20x120 cm Rect - 8"x48"



RIVESTIMENTO / WALL Hedge 50x100 cm Rect - 19¹/₂"x39"
PAVIMENTO / FLOOR Memory Mood Sheer Naturale 60x60 cm Rect - 24"x24"



RIVESTIMENTO / WALL **Relic 50x100 cm Rect - 19¹/₂"x39"**
PAVIMENTO / FLOOR **Context Hangar Naturale 90x90 cm Rect - 36"x36"**



RIVESTIMENTO / WALL **Boiserie Mauve 50x100 cm Rect - 19¹/₂"x39"**_Tartan Mauve 50x100 cm Rect - 19¹/₂"x39"
PAVIMENTO / FLOOR **Frame Glen Naturale 60x60 cm Rect - 24"x24"**



RIVESTIMENTO / WALL Washi 50x100 cm Rect - 19 1/2"x39"



RIVESTIMENTO / WALL Shapes 50x100 cm Rect - 19 1/2"x39"



RIVESTIMENTO / WALL **Reflex 50x100 cm Rect - 19 1/2"x39"**
PAVIMENTO / FLOOR **Context Loft Naturale 60x60 cm Rect - 24"x24"**



RIVESTIMENTO / WALL **Vibes 50x100 cm Rect - 19 1/2"x39"**
PAVIMENTO / FLOOR **Nuance Tabac Naturale 20x120 cm Rect - 8"x48"**

Glam

Natural Mood

MISTIC



2 moduli_2 modules_A+B

RAINFOREST



2 moduli_2 modules_A+B

HEDGE



2 moduli_2 modules_A+B

GREENWALL



5 moduli_5 modules_A+B+C+D+E

COLORFUL



5 moduli_5 modules_A+B+C+D+E

Glam

Geometric Mood

RELIC



2 moduli_2 modules_A+B

TARTAN MAUVE



1 modulo_1 module

TARTAN BEIGE



1 modulo_1 module

BOISERIE MAUVE



1 modulo_1 module

BOISERIE BEIGE



1 modulo_1 module

SHAPES



5 moduli_5 modules_A+B+C+D+E

WASHI



1 modulo_1 module

Glam

Materic Mood

REFLEX



5 moduli_5 modules_A+B+C+D+E

VIBES

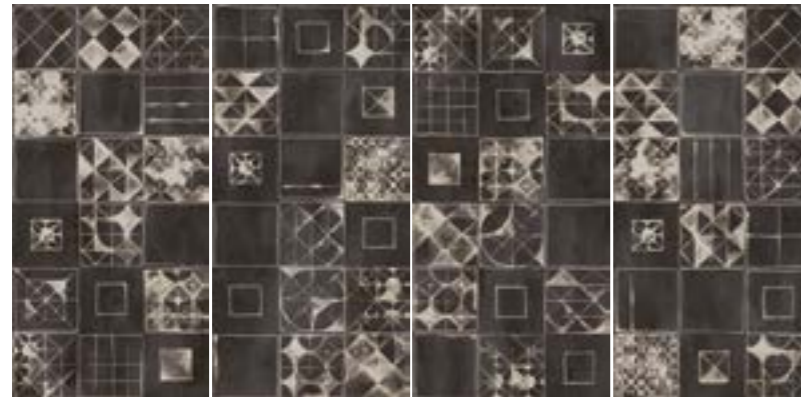

4 moduli_4 modules_A+B+C+D

Glam

GRES PORCELLANATO LAMINATO_LAMINATED PORCELAIN STONEWARE **Zero.3**



RIVESTIMENTI DECORATI DA INTERNO
INTERIOR DECORATED WALL COVERINGS

50x100 cm Rect - 19 1/2"x39"		50x100 cm Rect - 19 1/2"x39"		50x100 cm Rect - 19 1/2"x39"		50x100 cm Rect - 19 1/2"x39"	
Mistic A+B	PG9GM30	Colorful A	PG9GM4A	Relic A+B	PG9GM70	Reflex A	PG9GM8A
Rainforest A+B	PG9GM60	Colorful B	PG9GM4B	Tartan Mauve	PG9GM50	Reflex B	PG9GM8B
Hedge A+B	PG9GM00	Colorful C	PG9GM4C	Tartan Beige	PG9GM55	Reflex C	PG9GM8C
Greenwall A	PG9GM9A	Colorful D	PG9GM4D	Boiserie Mauve	PG9GM10	Reflex D	PG9GM8D
Greenwall B	PG9GM9B	Colorful E	PG9GM4E	Boiserie Beige	PG9GM20	Reflex E	PG9GM8E
Greenwall C	PG9GM9C			Shapes A	PG9GM6A	Vibes A	PG9GM3A
Greenwall D	PG9GM9D			Shapes B	PG9GM6B	Vibes B	PG9GM3B
Greenwall E	PG9GM9E			Shapes C	PG9GM6C	Vibes C	PG9GM3C
				Shapes D	PG9GM6D	Vibes D	PG9GM3D
				Shapes E	PG9GM6E		
				Washi	PG9GM40		

MISTIC - RAINFOREST - HEDGE - RELIC:
2 soggetti per scatola_2 patterns per box_2 Bilder
im Schachtel_2 motifs par boîte

DATI TECNICI_TECHNICAL DATA:

GRES PORCELLANATO LAMINATO
LAMINATED PORCELAIN STONEWARE

± 3,5 mm

ANSI A137.3: V0

Le lastre della collezione Glam sono decorate mediante la tecnologia di stampa digitale a freddo, che permette di raggiungere risultati estetici e cromatici di eccezionale qualità. Le grafiche vengono impresse ad altissima risoluzione sul supporto ceramico, mantenendo invariati i colori brillanti e le sfumature dei motivi decorativi.

The slabs of the Glam collection are decorated using digital cold printing technology, with which aesthetic, chromatic results of exceptional quality are achieved.

The graphics are printed at very high resolution on the ceramic substrate, keeping the brilliant colors and shades of the decorative designs unaltered.

Die Platten der Kollektion Glam werden nach dem Brennen im Digitaldruckverfahren dekoriert, mit dem sich optisch und farblich Ergebnisse von höchster Qualität erzielen lassen.

Die Motive werden mit extrem hoher Auflösung auf die Keramikfliese gedruckt, wobei die Leuchtkraft der Farben und die Nuancen der Motive perfekt erhalten bleiben.

Les dalles de la collection Glam sont décorées grâce à la technologie d'impression numérique à froid, qui permet d'obtenir des résultats esthétiques et chromatiques d'une qualité exceptionnelle.

Les graphismes sont imprimés en haute résolution sur le support céramique, en préservant la brillance des couleurs et les nuances des motifs décoratifs.

Attenzione: per la pulizia dei decori attenersi scrupolosamente alle istruzioni riportate a pagina 415_Note: for decors cleaning you should follow carefully the instructions provided on page 415_Achtung: für die Reinigung sich genau auf die Anleitungen auf der Seite 415 halten_Attention: pour le nettoyage des décors il faut suivre scrupuleusement les renseignements contenus à page 415

IMBALLAGGI E PESI_PACKINGS AND WEIGHTS

DESCRIZIONE Description	± mm	FORMATI Sizes	SCATOLA_Box				PALLET		
FONDO	3,5	50x100 RECT	2	7,8	1	-	25 box / 50 pz	195	25



Iqoniqa

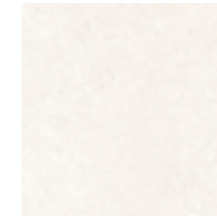

SILK



SKIN



VELVET



TOUCH

MONOPOROSA IN PASTA BIANCA SMALTATA_GLAZED WHITE BODY POROUS SINGLE-FIRED WALL TILES



± 8 mm



35x100 cm Rect
13^{3/4}"x39"

GRES PORCELLANATO A MASSA COLORATA_COLOURED-BODY PORCELAIN STONEWARE



± 8 mm



60x60 cm Rect
24"x24"

RIVESTIMENTO / WALL Touch 35x100 cm Rect - 13^{3/4}"x39" Poppy Warm 35x100 cm Rect - 13^{3/4}"x39"
PAVIMENTO / FLOOR Touch Naturale 60x60 cm Rect - 24"x24"



RIVESTIMENTO / WALL Silk 35x100 cm Rect - 13^{3/4}"x39" Brix Silk 35x100 cm Rect - 13^{3/4}"x39" Poppy Cold 35x100 cm Rect - 13^{3/4}"x39"
PAVIMENTO / FLOOR Silk Naturale 60x60 cm Rect - 24"x24"



RIVESTIMENTO / WALL **Brix Skin 35x100 cm Rect - 13^{3/4}"x39"**
 TOP CUCINA / COUNTERTOP **Blade Petrol Naturale**



RIVESTIMENTO / WALL **Blossom Silk 35x100 cm Rect - 13^{3/4}"x39"**
 PAVIMENTO / FLOOR **Kairos Listello Stigmi Naturale 7,5x60 cm Rect - 3"x24"**



RIVESTIMENTO / WALL Skin 35x100 cm Rect - 13^{3/4}"x39" _Spectrum 35x100 cm Rect - 13^{3/4}"x39"
PAVIMENTO / FLOOR Skin Naturale 60x60 cm Rect - 24"x24"



RIVESTIMENTO / WALL Velvet 35x100 cm Rect - 13^{3/4}"x39" _Stalks Warm 35x100 cm Rect - 13^{3/4}"x39"
PAVIMENTO / FLOOR Velvet Naturale 60x60 cm Rect - 24"x24"



RIVESTIMENTO / WALL Stalks Cold 35x100 cm Rect - 13^{3/4}"x39"
PAVIMENTO / FLOOR Touch Naturale 60x60 cm Rect - 24"x24"



RIVESTIMENTO / WALL Brix Touch 35x100 cm Rect - 13^{3/4}"x39"



RIVESTIMENTO / WALL Skin 35x100 cm Rect - 13^{3/4}"x39" Blossom Touch 35x100 cm Rect - 13^{3/4}"x39"
PAVIMENTO / FLOOR Skin Naturale 60x60 cm Rect - 24"x24"

Iqoniqa

PR()TECT
ANTIBATTERICO - ANTIMICROBIAL

SILK



SKIN





VELVET





TOUCH



DESTINAZIONI D'USO_INTENDED USE: NATURALE  

DATI TECNICI_TECHNICAL DATA:

GRES PORCELLANATO A MASSA COLORATA COLOURED-BODY PORCELAIN STONEWARE		MONOPOROSA IN PASTA BIANCA SMALTATA GLAZED WHITE BODY POROUS SINGLE-FIRED WALL TILES	
 8 mm		8 mm	
DIN EN 16165 - Annex B: R9 Naturale BCR TORTUS: $\mu > 0,40$ Naturale ANSI A326.3: ID - DCOF $\geq 0,42$ (dry) Naturale IW - DCOF $\geq 0,42$ (wet) Naturale	/		
 ANSI A137.1: V1		ANSI A137.1: V1	
PR()TECT ANTIBATTERICO - ANTIMICROBIAL	Naturale	/	

Iqoniqa

GRES PORCELLANATO A MASSA COLORATA_COLOURED-BODY PORCELAIN STONEWARE



60x60 cm Rect - 24"x24"

Silk NATURALE PGWIQ00
Skin NATURALE PGWIQ10
Touch NATURALE PGWIQ20
Velvet NATURALE PGWIQ30

MONOPOROSA IN PASTA BIANCA SMALTATA_GLAZED WHITE BODY POROUS SINGLE-FIRED WALL TILES*



35x100 cm Rect - 13^{3/4}"x39"

Silk PBFIQ00
Skin PBFIQ10
Touch PBFIQ20
Velvet PBFIQ30

DECORI_DECORS

MONOPOROSA IN PASTA BIANCA SMALTATA_GLAZED WHITE BODY POROUS SINGLE-FIRED WALL TILES

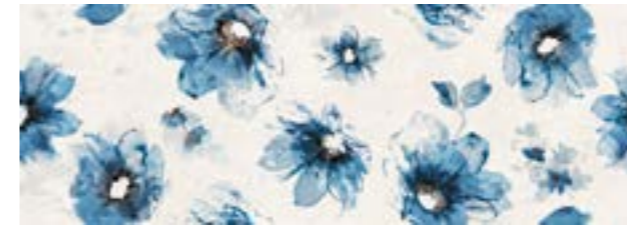

POPPY COLD
35x100 cm Rect - 13^{3/4}"x39"
 8 mm
PBFIQP0

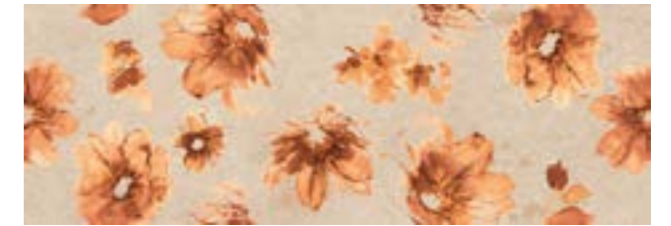

POPPY WARM
35x100 cm Rect - 13^{3/4}"x39"
 8 mm
PBFIQP1



STALKS COLD
35x100 cm Rect - 13^{3/4}"x39"
 8 mm
PBFIQC0



STALKS WARM
35x100 cm Rect - 13^{3/4}"x39"
 8 mm
PBFIQW0



SPECTRUM
35x100 cm Rect - 13^{3/4}"x39"
 8 mm
PBFIQS0

POPPY COLD - POPPY WARM:
Sviluppati su 6 soggetti_Developed on 6 patterns_Entwickelt auf 6 Bilder_Développé sur 6 éléments

I soggetti all'interno della scatola sono presenti in modo casuale_The patterns are placed in the box randomly_Die Dekor-Bilder sind zufällig eingepackt_Les sujets à l'intérieurs de la boîte son présent de façon casuelle

Iqoniqa

DECORI_DECORS

MONOPOROSA IN PASTA BIANCA SMALTATA_GLAZED WHITE BODY POROUS SINGLE-FIRED WALL TILES



BLOSSOM SILK
35x100 cm Rect - 13^{3/4}"x39"
± 8 mm
PBFIQL0



BLOSSOM SKIN
35x100 cm Rect - 13^{3/4}"x39"
± 8 mm
PBFIQL1



BLOSSOM VELVET
35x100 cm Rect - 13^{3/4}"x39"
± 8 mm
PBFIQL3



BLOSSOM TOUCH
35x100 cm Rect - 13^{3/4}"x39"
± 8 mm
PBFIQL2



BRIX SILK
35x100 cm Rect - 13^{3/4}"x39"
± 9,5 mm
PBFIQB0



BRIX SKIN
35x100 cm Rect - 13^{3/4}"x39"
± 9,5 mm
PBFIQB1



BRIX VELVET
35x100 cm Rect - 13^{3/4}"x39"
± 9,5 mm
PBFIQB3



BRIX TOUCH
35x100 cm Rect - 13^{3/4}"x39"
± 9,5 mm
PBFIQB2

Iqoniqa

PEZZI SPECIALI_TRIM PIECES

GRES PORCELLANATO A MASSA COLORATA_COLOURED-BODY PORCELAIN STONEWARE

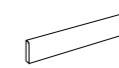

BATTISCOPA
7,5x60 cm Rect - 3"x24"
± 8 mm
NATURALE

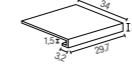

GRADONE A COSTA RETTA
30x34 cm Rect - 12"x13^{3/8}"
± 8 mm
NATURALE

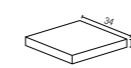

ANGOLO GRADONE A COSTA RETTA
34x34 cm - 13^{3/8}"x13^{3/8}"
± 8 mm
NATURALE

SILK	PGRIQ00	PGDIQ00	PGDIQ01
SKIN	PGRIQ10	PGDIQ10	PGDIQ11
TOUCH	PGRIQ20	PGDIQ20	PGDIQ21
VELVET	PGRIQ30	PGDIQ30	PGDIQ31

IMBALLAGGI E PESI_PACKINGS AND WEIGHTS

DESCRIZIONE Description	± mm	FORMATI Sizes	SCATOLA_Box				PALLET		
FONDO NATURALE	8	60x60 ^{RECT}	4	25,6	1,44	-	36	921,6	51,84
FONDO	8	35x100 ^{RECT}	4	20,4	1,4	-	26	530,4	36,4
BRIX	9,5	35x100 ^{RECT}	3	17,8	1,05	-	26	462,8	27,3
BLOSSOM	8	35x100 ^{RECT}	4	20,4	1,4	-	26	530,4	36,4
POPPY COLD	8	35x100 ^{RECT}	4	20,4	1,4	-	26	530,4	36,4
POPPY WARM	8	35x100 ^{RECT}	4	20,4	1,4	-	26	530,4	36,4
STALKS COLD	8	35x100 ^{RECT}	4	20,4	1,4	-	26	530,4	36,4
STALKS WARM	8	35x100 ^{RECT}	4	20,4	1,4	-	26	530,4	36,4
SPECTRUM	8	35x100 ^{RECT}	4	20,4	1,4	-	26	530,4	36,4
BATTISCOPA NATURALE	8	7,5x60 ^{RECT}	14	13,55	0,63	8,4	60	813	37,8
GRADONE A COSTA RETTA NATURALE	8	30x34 ^{RECT}	6	17,1	0,612	-	30	513	18,36
ANGOLO GRADONE A COSTA RETTA NATURALE	8	34x34	2	6,27	0,2312	-	48	300,96	11,098



Must

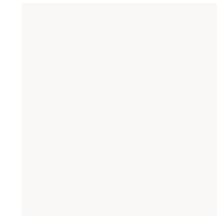

BE WHITE



BE BLACK

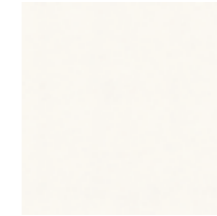

STAR WHITE

GRES PORCELLANATO LAMINATO_LAMINATED PORCELAIN STONEWARE **Zero.3**



± 5,5 mm



100x300 cm Rect
39"x118"

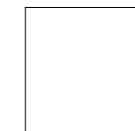

100x100 cm Rect
39"x39"

± 3,5 mm



100x300 cm Rect
39"x118"



100x100 cm Rect
39"x39"



50x100 cm Rect
19^{1/2}"x39"



RIVESTIMENTO / WALL Be White Soft 100x300 cm Rect - 39"x118"
PAVIMENTO / FLOOR Be White Lux 100x100 cm Rect - 39"x39"



RIVESTIMENTO / WALL Star White Smooth 100x100 cm Rect - 39"x39"
PAVIMENTO / FLOOR Star White Smooth 100x300 cm Rect - 39"x118" _Glam Rainforest 50x100 cm Rect - 19 1/2"x39"

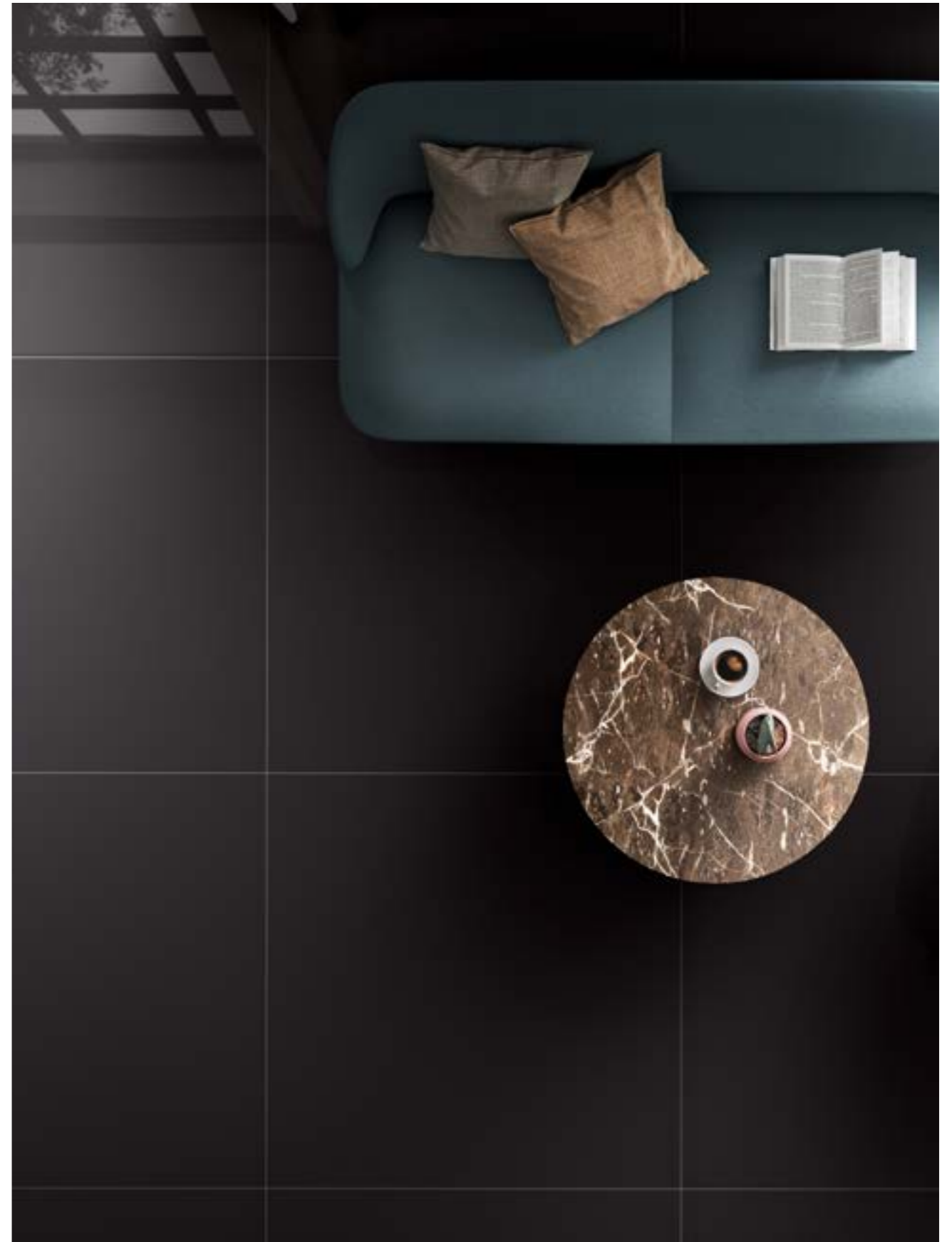

PAVIMENTO / FLOOR Be Black Lux 100x100 cm Rect - 39"x39"



RIVESTIMENTO / WALL Be Black Soft 100x300 cm Rect - 39"x118"
PAVIMENTO / FLOOR Be Black Lux 100x100 cm Rect - 39"x39"

Must

PR()TECT
ANTIBATTERICO - ANTIMICROBIAL

BE WHITE

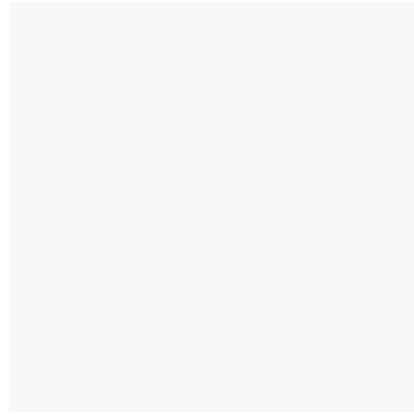

BE BLACK



STAR WHITE



DESTINAZIONI D'USO_INTENDED USE: SOFT SMOOTH LUX *solo Be White_only Be White

DATI TECNICI_TECHNICAL DATA:

GRES PORCELLANATO LAMINATO LAMINATED PORCELAIN STONEWARE		GRES PORCELLANATO LAMINATO LAMINATED PORCELAIN STONEWARE	
± 5,5 mm		3,5 mm	
ANSI A326.3: ID - DCOF ≥ 0.42 (dry) Soft - Lux IW - DCOF ≥ 0.42 (wet) Soft		ANSI A326.3: ID - DCOF ≥ 0.42 (dry) Smooth	
ANSI A137.3: V1 Soft - Lux		ANSI A137.3: V1 Smooth	
PR()TECT ANTIBATTERICO - ANTIMICROBIAL Soft - Lux		PR()TECT ANTIBATTERICO - ANTIMICROBIAL Smooth	

Must

GRES PORCELLANATO LAMINATO_LAMINATED PORCELAIN STONEWARE **Zero.3**



± 5,5 mm

100x300 cm Rect - 39"x118"

Be White SOFT PZ7MT10
Be Black SOFT PZ7MT00

Be White LUX PZ7MTX1
Be Black LUX PZ7MTX0



± 5,5 mm

100x100 cm Rect - 39"x39"

Be White SOFT PZ8MT10
Be Black SOFT PZ8MT00

Be White LUX PZ8MTX1
Be Black LUX PZ8MTX0



± 3,5 mm

100x300 cm Rect - 39"x118"

Star White SMOOTH PZ7MT25

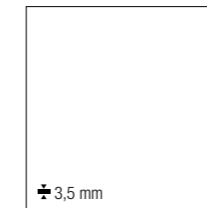

± 3,5 mm

100x100 cm Rect - 39"x39"

Star White SMOOTH PZ8MT25



± 3,5 mm

50x100 cm Rect - 19^{1/2}"x39"

Star White SMOOTH PZ9MT25

IMBALLAGGI E PESI_PACKINGS AND WEIGHTS

DESCRIZIONE Description	± mm	FORMATI Sizes	SCATOLA_Box				PALLET		
FONDO SOFT / LUX	5,5	100x300 ^{RECT}	1	34,5	3	-	13	448,5	39
FONDO SOFT / LUX	5,5	100x100 ^{RECT}	2	23	2	-	25	575	50
FONDO SMOOTH	3,5	100x300 ^{RECT}	1	23,4	3	-	20	468	60
FONDO SMOOTH	3,5	100x100 ^{RECT}	3	23,4	3	-	25	585	75
FONDO SMOOTH	3,5	50x100 ^{RECT}	5	19,5	2,5	-	32	624	80



Wallcraft



WAX



VANILLA



GEM



TAN



SPRING



MINT



WAVE

MONOPOROSA IN PASTA BIANCA SMALTATA_GLAZED WHITE BODY POROUS SINGLE-FIRED WALL TILES



± 8 mm



35x100 cm Rect
13^{3/4}"x39"



RIVESTIMENTO / WALL Wave 35x100 cm Rect - 13^{3/4}"x39" _Impulse 35x100 cm Rect - 13^{3/4}"x39" _Enigma Wax 35x100 cm Rect - 13^{3/4}"x39"
PAVIMENTO / FLOOR Context Loft Naturale 90x90 cm Rect - 36"x36"



RIVESTIMENTO / WALL **Bloom Cold 35x100 cm Rect - 13^{3/4}"x39"** _Tan 35x100 cm Rect - 13^{3/4}"x39"
 PAVIMENTO / FLOOR **Borealis Alta Naturale 20x120 cm Rect - 8"x48"**



RIVESTIMENTO / WALL **Gem 35x100 cm Rect - 13^{3/4}"x39"** _Enigma Wax 35x100 cm Rect - 13^{3/4}"x39"
 PAVIMENTO / FLOOR **Borealis Donegal Naturale 30x180 cm Rect - 12"x71"**



RIVESTIMENTO / WALL Mint 35x100 cm Rect - 13^{3/4}"x39" Gallery 35x100 cm Rect - 13^{3/4}"x39"
PAVIMENTO / FLOOR Memory Mood Sheer Naturale 60x60 cm Rect - 24"x24"



RIVESTIMENTO / WALL Bloom Warm 35x100 cm Rect - 13^{3/4}"x39"



RIVESTIMENTO / WALL Vanilla 35x100 cm Rect - 13^{3/4}"x39" Spring 35x100 cm Rect - 13^{3/4}"x39"

Wallcraft

WAX



VANILLA



GEM



TAN



SPRING



MINT



WAVE



DATI TECNICI / TECHNICAL DATA:

MONOPOROSA IN PASTA BIANCA SMALTATA
GLAZED WHITE BODY POROUS SINGLE-FIRED WALL TILES

✚ 8 mm

ANSI A137.1: V1

Wallcraft

MONOPOROSA IN PASTA BIANCA SMALTATA / GLAZED WHITE BODY POROUS SINGLE-FIRED WALL TILES



35x100 cm Rect - 13^{3/4}"x39"

Wax PBFWL60S
Vanilla PBFWL40S
Gem PBFWL00S
Tan PBFWL30S
Spring PBFWL20S
Mint PBFWL10S
Wave PBFWL50S

DECORI / DECORS

MONOPOROSA IN PASTA BIANCA SMALTATA / GLAZED WHITE BODY POROUS SINGLE-FIRED WALL TILES



IMPULSE
35x100 cm Rect - 13^{3/4}"x39"
✚ 8 mm
PBFWL10S



GALLERY
35x100 cm Rect - 13^{3/4}"x39"
✚ 8 mm
PBFWL60S



BLOOM COLD
35x100 cm Rect - 13^{3/4}"x39"
✚ 8 mm
PBFWLCOS



BLOOM WARM
35x100 cm Rect - 13^{3/4}"x39"
✚ 8 mm
PBFWLWOS

DECORI / DECORS

I soggetti all'interno della scatola sono presenti in modo casuale. / The patterns are placed in the box randomly. / Die Dekor-Bilder sind zufällig eingepackt. / Les sujets à l'intérieur de la boîte sont présent de façon casuelle.

IMPULSE:

Sviluppato su 4 soggetti / Developed on 4 patterns / Entwickelt auf 4 Bilder / Développé sur 4 éléments

GALLERY:

Sviluppato su 3 soggetti / Developed on 3 patterns / Entwickelt auf 3 Bilder / Développé sur 3 éléments

BLOOM COLD:

Sviluppato su 4 soggetti / Developed on 4 patterns / Entwickelt auf 4 Bilder / Développé sur 4 éléments

Abbinabile ai colori / Matches with colors / Mit den Farben kombinierbar / À combiner avec les couleurs: **WAX - GEM - TAN**

BLOOM WARM:

Sviluppato su 4 soggetti / Developed on 4 patterns / Entwickelt auf 4 Bilder / Développé sur 4 éléments

Abbinabile ai colori / Matches with colors / Mit den Farben kombinierbar / À combiner avec les couleurs: **VANILLA - SPRING - WAVE - TAN**

Wallcraft

DECORI_DECORS

MONOPOROSA IN PASTA BIANCA SMALTATA_GLAZED WHITE BODY POROUS SINGLE-FIRED WALL TILES



ENIGMA WAX
35x100 cm Rect - 13^{3/4}"x39"
± 8 mm
PBFWLE6S



ENIGMA VANILLA
35x100 cm Rect - 13^{3/4}"x39"
± 8 mm
PBFWLE4S



ENIGMA SPRING
35x100 cm Rect - 13^{3/4}"x39"
± 8 mm
PBFWLE2S



ENIGMA MINT
35x100 cm Rect - 13^{3/4}"x39"
± 8 mm
PBFWLE1S



ENIGMA WAVE
35x100 cm Rect - 13^{3/4}"x39"
± 8 mm
PBFWLE5S

IMBALLAGGI E PESI_PACKINGS AND WEIGHTS

DESCRIZIONE Description	± mm	FORMATI Sizes	SCATOLA_Box				PALLET		
FONDO	8	35x100 ^{RECT}	4	20,4	1,4	-	26	530,4	36,4
ENIGMA	8	35x100 ^{RECT}	4	20,4	1,4	-	26	530,4	36,4
IMPULSE	8	35x100 ^{RECT}	4	20,4	1,4	-	26	530,4	36,4
GALLERY	8	35x100 ^{RECT}	4	20,4	1,4	-	26	530,4	36,4
BLOOM COLD	8	35x100 ^{RECT}	4	20,4	1,4	-	26	530,4	36,4
BLOOM WARM	8	35x100 ^{RECT}	4	20,4	1,4	-	26	530,4	36,4

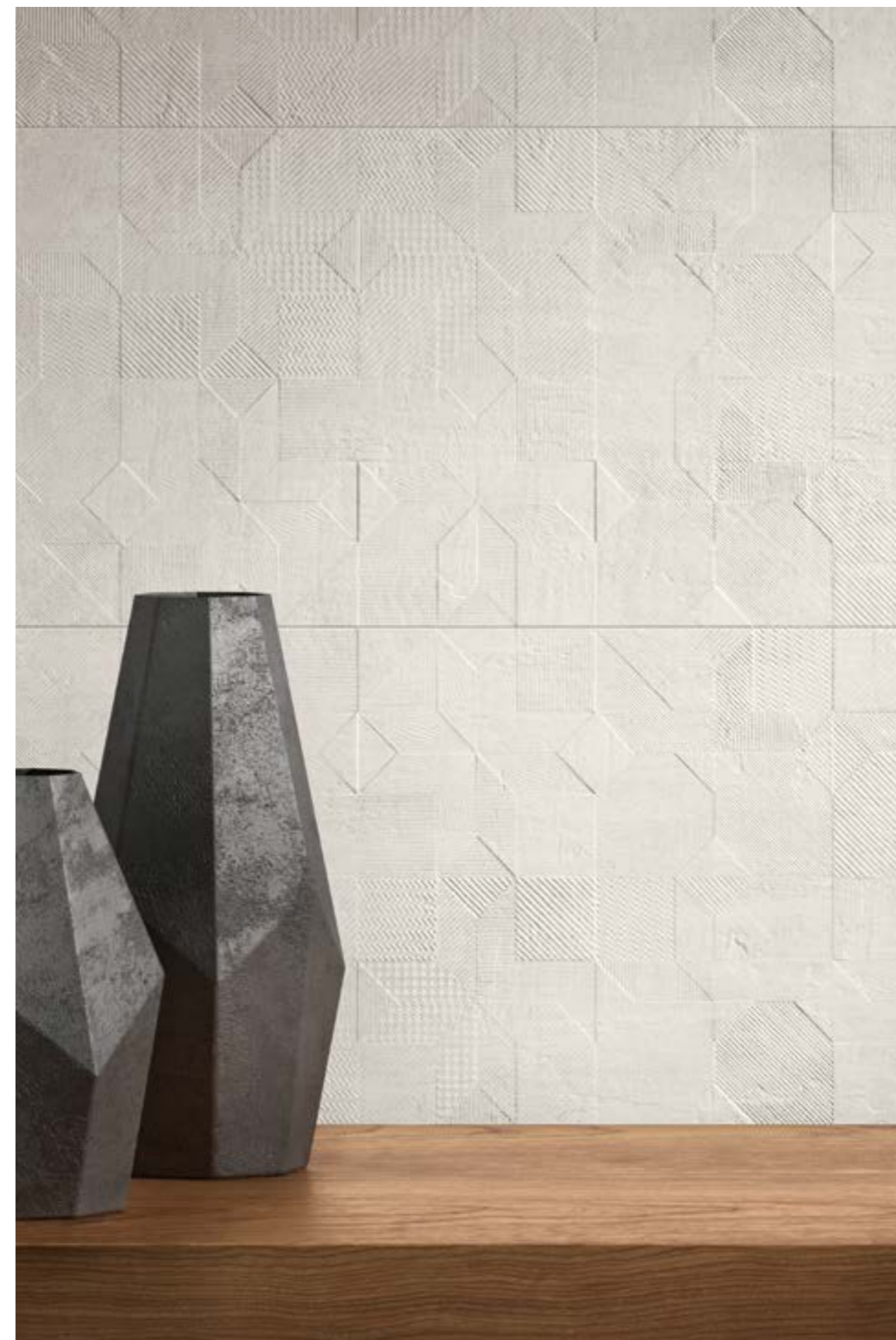

RIVESTIMENTO / WALL Enigma Wax 35x100 cm Rect - 13^{3/4}"x39"

Dati tecnici

Technical data_Technische Daten_ Données techniques

Panaria sviluppo ecosostenibile	394
Panaria sustainable development_Panaria umweltschonende nachhaltige Entwicklung_Panaria développement durable	
Certificazioni di sistema	398
Management system certifications_Qualitätssystem Zertifizierungen_Certifications du système de gestion	
Certificazioni di prodotto	399
Product certifications_Produktzertifizierungen_Certifications de produits	
Prodotti certificati	401
Certified products_Zertifizierte Produkte_Produits certifiés	
Norme tecniche di riferimento	402
Technical standards_Technische Bezugsnormen_Normes techniques	
Caratteristiche tecniche	408
Technical features_Technische Eigenschaften_Caractéristiques techniques	
Destinazioni d'uso	416
Intended use_Einsatzbereiche_Utilisations prévues	
Tabelle calibri	418
Size table_Formattabellen_Tableaux des calibres	
Suggerimenti per la posa	420
Laying suggestions_Empfehlungen für das Verlegen_Conseils pour la pose	
Informazioni per la pulizia e la manutenzione	422
Cleaning and maintenance information_Informationen zur reinigung und pflege_Informations sur le nettoyage et l'entretien	
Resistenza allo scivolamento	427
Slip resistance_Rutschfestigkeit_Résistance au glissement	
Indice alfabetico dei prodotti	428
List of products in alphabetical order_Alphabetisches verzeichnis der Produkte_Index alphabétique des produits	
Condizioni generali di vendita	432
General terms and conditions of sale_Allgemeine Verkaufsbedingungen_Conditions générales de vente	

Panaria sviluppo ecosostenibile

Panaria sustainable development_Panaria umweltschonende nachhaltige Entwicklung_Panaria développement durable

Panaria e l'ambiente

Da sempre Panaria considera la tutela dell'ambiente un aspetto di grande rilevanza

- investendo in modo deciso nell'acquisto delle migliori tecnologie presenti sul mercato per ridurre al minimo gli impatti ambientali delle proprie attività;
- dotando tutti i dipendenti di un ambiente di lavoro ottimale;
- ottenendo prestigiose certificazioni ambientali.

Tutti i prodotti Panaria sono realizzati presso stabilimenti produttivi dotati di **Sistemi di Gestione Ambientale certificati**:
ISO 14001: 2015 (norma riconosciuta a livello internazionale);
EMAS (Regolamento Europeo - Reg. CE 1221/2009, Reg. UE 2017/1505, Reg. UE 2018/2026).

THINK ZERO: le lastre ultrasottili Zero.3 di Panaria sono totalmente carbon neutral e prodotte con una tecnologia innovativa in grado di ridurre al minimo l'impatto ambientale: la CO₂ generata dal ciclo di vita di questo prodotto è stata neutralizzata al 100% con l'acquisto di **carbon credit** appartenenti allo **standard CDM (Clean Development Mechanism)**.

Panaria salvaguardia dell'ambiente

L'incessante ricerca di prestazioni di eccellenza in merito al rispetto dell'ambiente ha condotto Panaria al costante rispetto dei seguenti principi:



RIUTILIZZO DEL 100% DEGLI SCARTI CRUDI

Il 100% degli scarti crudi derivanti dal ciclo di produzione vengono riutilizzati nella fase di preparazione dell'impasto, contribuendo in modo sensibile alla salvaguardia delle risorse naturali riducendo l'estrazione di materie prime da cava.



RIUTILIZZO/RICICLO DEL 100% DEGLI SCARTI COTTI

Gli scarti cotti sono completamente riutilizzati nel ciclo produttivo. Inoltre, a fine vita, le piastrelle Panaria possono essere riciclate come inerti per sottofondi di strade ed edifici, riducendo così l'uso di ghiaia ed inerti naturali comunemente utilizzati in edilizia.



RICICLO DEL 100% DEI RIFIUTI NON CERAMICI

Il 100% dei rifiuti non ceramici derivanti dalle attività produttive è gestito in modo differenziato e riciclato in altri processi produttivi.



RIUTILIZZO DEL 100% DELLE ACQUE DI PROCESSO

La produzione di piastrelle di ceramica richiede ingenti quantitativi di acqua. Per salvaguardare questa importante risorsa naturale Panaria riutilizza il 100% delle acque reflue derivanti dal ciclo di produzione, generando una riduzione fino all'80% del fabbisogno idrico degli stabilimenti.



BASSE EMISSIONI IN ATMOSFERA

Gli importanti investimenti attuati nelle migliori tecnologie a disposizione permettono di realizzare i prodotti Panaria riducendo al minimo le emissioni gassose in atmosfera, raggiungendo livelli 10 volte inferiori ai severi limiti ambientali richiesti della legislazione italiana.



FORTE RIDUZIONE DEI CONSUMI ENERGETICI

L'uso di tecnologie all'avanguardia e di soluzioni impiantistiche ottimali riducono sensibilmente l'uso di gas metano nel processo produttivo.



UTILIZZO DI IMBALLAGGI 100% RICICLABILI

I materiali impiegati per gli imballaggi dei prodotti Panaria (quali scatole, cartone, plastica, palette in legno, etc.) sono completamente riciclabili.



PALLET FAO

Panaria utilizza pallet senza corteccia conformi allo standard IPPC / FAO ISPM 15, offrendo quindi ai Paesi importatori ogni garanzia per la salvaguardia del proprio patrimonio forestale.

Panaria and the environment

Panaria has always considered environmental protection a matter of key importance

- investing in the best technologies on the market to minimize the environmental impact of its activities;
- giving all employees an excellent working environment;
- obtaining prestigious environmental certifications.

All Panaria products are manufactured in production sites that are certified with **Environmental Management Systems**:
ISO 14001: 2015 (internationally recognized standard);
EMAS (European Regulation - Reg. CE 1221/2009, Reg. UE 2017/1505, Reg. UE 2018/2026).

THINK ZERO: the ultra-thin Zero.3 slabs by Panaria, are totally carbon neutral and produced with innovative technology able to minimise the environmental impact: the CO₂ generated by the life cycle of this product has been 100% neutralised with the purchase of **carbon credits** belonging to the **CDM (Clean Development Mechanism) standard**.

Panaria cares for the environment

The relentless pursuit of excellence in environmental performance has driven Panaria to adhere to the following principles:



100% INDUSTRIAL WASTE REUSED – NON FIRED TILES

100% of the non fired material from the production cycle is reused in the preparation of the mixture, contributing significantly to the protection of natural resources by reducing the extraction of raw materials from quarries.



100% REUSE/RECYCLING OF INDUSTRIAL WASTE – FIRED TILES

Waste-fired tiles are fully reused in the production cycle. In addition, at the end of life, Panaria tiles can be recycled as materials for substrates for roads and buildings, thus reducing the use of gravel and natural aggregates commonly used in building.



100% INDUSTRIAL WASTE RECYCLED – NON CERAMIC WASTE

All non ceramic waste is sorted and recycled in other production cycles.



100% REUSE OF PROCESS WATER

The production of tiles requires large amounts of water. So as to safeguard this precious resource Panaria recycles 100% of waste water from the production cycle. This allows the reduction of water consumption by up to 80%.



LOW GAS EMISSIONS INTO THE ATMOSPHERE

Significant investments in the best available technologies allow Panaria products to be manufactured with minimal gaseous emissions into the atmosphere, reaching levels 10 times lower than the strict environmental limits required by Italian legislation.



SUBSTANTIAL REDUCTIONS IN ENERGY CONSUMPTION

The use of state-of-the-art technology and optimal plant solutions significantly reduce the use of methane gas in the production process.



100% RECYCLABLE MATERIAL USED FOR PACKAGING

The materials used for the packing of Panaria products are completely recyclable. These materials include cardboard boxes, plastic materials, wooden pallets, etc.



FAO PALLETS

Panaria uses bark-free pallets that comply with the IPPC / FAO ISPM 15 standard, thus offering importing countries every guarantee for the protection of their forest resources.



Panaria und die Umwelt

Seit jeher misst Panaria dem Umweltschutz größte Bedeutung zu

- indem das Unternehmen zielbewusst in die Ausstattung der besten auf dem Markt vorhandenen Technologien investiert, um die Umweltbelastung ihrer Aktivitäten drastisch zu reduzieren;
- indem es allen Mitarbeitern ein optimales Arbeitsumfeld bietet;
- indem es wichtige, internationale Öko-Zertifikate erlangt.

Alle Produkte von Panaria sind bei Produktionsstätten hergestellt, die mit **umweltfreundlichen Managementsystemen ausgestattet** sind
ISO 14001: 2015 (weltweit anerkannte Norm)
EMAS (europäische Regelung - Reg. CE 1221/2009, Reg. UE 2017/1505, Reg. UE 2018/2026).

THINK ZERO: Die ultradünnen Platten Zero.3 von Panaria sind absolut kohlenstoffneutral und werden mit einer innovativen Technologie hergestellt, die die Umweltauswirkungen auf ein Minimum reduzieren kann: Das vom Lebenszyklus dieser Produkte generierte CO₂ wurde mit dem Kauf von **CO₂-Zertifikaten** nach dem **CDM-Standard** (Clean Development Mechanism; Mechanismus für umweltverträgliche Entwicklung) zu 100% neutralisiert.

Panaria und Umweltschutz

Das unermüdliche Streben nach ausgezeichneten Umweltschutzleistungen hat Panaria zur ständigen Einhaltung der folgenden Grundsätze veranlasst:



WIEDERVERWERTUNG VON 100% DER ROHABFÄLLE

100% der Rohabfälle aus dem Produktionszyklus werden in der Vorbereitungsphase des Gemisches wiederverwertet und tragen somit ihren Teil zum Schutz der Naturressourcen bei, indem sie den Abbau von Rohmaterialien verringern.



WIEDERVERWENDEUNG-/VERWERTUNG ZU 100% DER BEIM BRENNEN DER FLIESEN ANFALLENDEN ABFÄLLE

Die beim Brennen der Fliesen anfallenden Abfälle werden vollständig wieder in den Produktionszyklus aufgenommen. Außerdem können die Fliesen Panaria nach ihrem "Lebensende" als inertes Material als Untergrund für Straßen oder Gebäude verwendet werden und somit den Einsatz von gewöhnlicherweise im Bauwesen eingesetzten Kies und inerten Naturmaterialien reduzieren.



100% RECYCLING DES NICHT KERAMISCHEN ABFALLS

100% der während des Produktionsprozess anfallenden nicht keramischen Abfälle wird getrennt verwaltet und in anderen Produktionsprozessen wiederverwertet.



WIEDERVERWERTUNG VON 100% DES ABWASSERS

Die Herstellung von Keramikfliesen erfordert beträchtliche Wassermengen. Um diese wichtige Naturressource zu schützen, verwertet Panaria 100% der Abwässer des Produktionszyklus wieder und ermöglicht somit eine Reduktion des Wasserbedarfs in den Anlagen von bis zu 80%.



NIEDRIGE EMISSIONSWERTE

Dank der starken Investitionen in die modernsten, verfügbaren Produktionstechnologien ist es uns möglich, sämtliche Produkte von Panaria so herzustellen, dass die Schadstoffemissionen in die Atmosphäre auf das Geringste reduziert werden. Wir erreichen dabei ein Niveau, das 10 mal unter den strengen Grenzwerten der italienischen Gesetzgebung liegt.



BETRÄCHTLICHE REDUZIERUNG DES ENERGIEBEDARFS

Der Einsatz fortschrittlicher Technologien und optimaler Lösungen beim Bau der Anlagen reduzieren den Einsatz von Methangas beim Produktionsprozess auf beträchtliche Weise.



VERWENDUNG VON 100% RECYCLEBAREN VERPACKUNGEN

Die Materialien, die zur Verpackung der Produkte von Panaria verwendet werden (Schachteln, Kartons, Kunststoffe, Holzpaletten, usw.) sind vollständig recyclebar.



FAO-PALETTEN

Panaria verwendet gemäß Standard IPPC/FAO ISPM 15 rindenfreie Paletten (DB) und gibt daher den Importländern die Garantie für den Schutz ihres Waldbestandes.

Panaria et l'environnement

Depuis toujours Panaria considère la protection de l'environnement un aspect très important

- en investissant dans l'acquisition des meilleures technologies présentes sur le marché afin de réduire au minimum l'impact environnemental de ses activités ;
- en offrant à tous ses employés un environnement de travail optimal ;
- en obtenant de prestigieuses certifications environnementales.

Tous les produits Panaria sont fabriqués dans des sites de production dotés de **Systèmes de Gestion Environnementale certifiés** :
ISO 14001:2015 (norme reconnue au niveau international)
EMAS (Règlement européen - Régl. CE 1221/2009, Régl. UE 2017/1505, Régl. UE 2018/2026).

THINK ZERO : les dalles ultra fin Zero.3 de Panaria, sont totalement neutres en carbone et produites avec une technologie révolutionnaire, permettant de réduire au minimum l'incidence sur l'environnement : le CO₂ généré par le cycle de vie de ce produit a été neutralisé à 100% par l'achat de **crédits carbone** dans le cadre de la **norme MDP (Mécanisme de Développement Propre)**.

Panaria se soucie de l'environnement

La recherche incessante de l'excellence de Panaria nous a conduit à respecter les principes suivants en matière d'environnement:



RÉUTILISATION DE 100 % DES DÉCHETS BRUTS

100 % des déchets bruts provenant du cycle de production sont réutilisés pendant la phase de préparation de la pâte, contribuant sensiblement à la préservation des ressources naturelles réduisant l'extraction de matières premières minières.



RÉUTILISATION/RECYCLAGE DE 100 % DES REJETS DE CUISSON

Les rejets de cuisson sont entièrement réutilisés dans le cycle de production. En fin de vie, les carreaux Panaria peuvent par ailleurs être utilisés comme granulats pour les soubassements de routes et de bâtiments, ce qui permet de réduire l'utilisation de gravier et de granulats naturels habituellement utilisés en construction.



RECYCLAGE DE 100 % DES DÉCHETS NON CÉRAMIQUES

100 % des déchets non céramiques provenant des activités de production sont triés de façon sélective puis recyclés dans d'autres processus de production.



RÉUTILISATION DE 100 % DES EAUX DE TRAITEMENT

La production de carreaux de céramique nécessite de grandes quantités d'eau. Pour sauvegarder cette importante ressource naturelle, Panaria réutilise 100 % des eaux usées provenant du cycle de production, générant une réduction jusqu'à 80% des besoins en eau des établissements.



BASSES ÉMISSIONS DANS L'ATMOSPHÈRE

Les importants investissements actuels dans les meilleures technologies qui sont à notre disposition permettent de réaliser les produits Panaria, en réduisant au minimum les émissions de gaz dans l'atmosphère, et en atteignant des niveaux dix fois inférieurs aux limites environnementales très strictes fixées par la législation italienne.



FORTE RÉDUCTION DES CONSOMMATIONS ÉNERGÉTIQUES

L'utilisation de technologies de pointe et de solutions d'installations optimales permettent de réduire considérablement la consommation de gaz méthane dans le processus de production.



UTILISATION D'EMBALLAGES 100 % RECYCLABLES

Les matériaux utilisés pour les emballages des produits Panaria (tels que boîtes, carton, plastique, palettes en bois, etc.) sont complètement recyclables.



PALETTES FAO

Panaria utilise des palettes sans écorce (DB) conformes aux normes IPPC / FAO ISPM 15, offrant donc aux Pays importateurs la garantie de la préservation du patrimoine forestier.

Panaria sviluppo ecosostenibile

Panaria sustainable development_Panaria umweltschonende nachhaltige Entwicklung_
Panaria développement durable

Zero.3

Zero.3 Materiale ideale per edifici a basso consumo energetico

Zero.3 Ideal material for low energy buildings_Zero.3 ideal für energieeffiziente Gebäude_
Zero.3 Matériau idéal pour édifices à faible consommation énergétique

Zero.3 è ideale per la costruzione di edifici a bassissimo consumo energetico; queste sono le applicazioni nelle quali Zero.3 è il materiale ottimale:

Finitura di pavimenti e rivestimenti

Zero.3 è un prodotto realizzato con materie prime naturali che non contengono sostanze sintetiche, che offre prestazioni di sicurezza (resistenza al fuoco), pulibilità e durabilità decisamente superiori rispetto al legno e alla moquette.

Impianti di riscaldamento a pavimento

Zero.3 offre prestazioni di eccellenza poiché favorisce l'ottimizzazione del sistema completo con temperature più basse dell'acqua e di conseguenza il risparmio energetico dell'intero impianto (grazie al suo basso spessore e alla conducibilità termica superiore rispetto al legno che è materiale isolante).

Finiture superficiali di rivestimenti a cappotto e facciate ventilate

L'utilizzo di Zero.3 è indicato per la sua leggerezza, il grande formato e la facilità di installazione. Inoltre, rispetto a materiali lapidei o metallici e rispetto alle finiture ad intonaco, Zero.3 offre sicuramente una maggiore resistenza agli agenti atmosferici, allo smog, agli agenti chimici, alle macchie e ai graffiti, e caratteristiche di eccellenza per quanto riguarda la durabilità nel tempo (resistenza all'invecchiamento, all'azione della luce e del gelo).

Finitura di pannelli di tamponamento esterno per strutture e case prefabbricate

Zero.3 è la soluzione ottimale grazie alle sue caratteristiche tecniche, alla sua leggerezza e al grande formato.

Zero.3 is ideal for the construction of low energy consumption buildings and these are the applications in which Zero.3 is the optimal material:

Floor and wall coverings

Zero.3 is manufactured with raw materials that do not contain any synthetic substances and therefore offers the security of fire resistance, durability and easy cleaning superior to that of wood and carpet.

Floor heating systems

Zero.3 assists with the optimization of the complete system by requiring lower water temperatures and consequently saving energy. This is due to its thickness and thermal conductivity which render it superior to moquette and wood.

Surface coverings for thermal insulation systems and ventilated facades

Zero.3 is recommended for its lightness, large size and easy installation. Moreover, when compared to stone, metallic or plaster materials Zero.3 offers a noticeably higher resistance to atmospheric agents, pollution, chemical agents, stains and graffiti, along with excellent durability (resistance to aging and the effects of light and frost).

Finish of external walls plugs for structures and prefabricate buildings

Zero.3 is the perfect solution thanks to its technical characteristics, lightness and large sizes.

Zero.3 ist ideal für den Bau von Gebäuden mit sehr niedrigem Energieverbrauch; dies sind die Anwendungen, in denen Zero.3 das optimale Material ist:

Endbearbeitung von Böden und Wänden

Zero.3 ist ein Produkt aus natürlichen Rohstoffen, die keine synthetischen Substanzen enthalten, das eine Sicherheitsleistung (Brandschutz), Reinigungsfähigkeit und Haltbarkeit bietet, die Holz und Teppichen weit überlegen ist.

Fußbodenheizungssysteme

Zero.3 bietet eine ausgezeichnete Leistungen, da es die Optimierung des Gesamtsystems mit niedrigeren Wassertemperaturen und damit die Energieeinsparung des Gesamtsystems begünstigt (dank seiner geringen Stärke und höheren Wärmeleitfähigkeit im Vergleich zu Holz, das ein Dämmstoff ist).

Oberflächenveredelung von Außenverkleidungen und hinterlüfteten Fassaden

Die Verwendung von Zero.3 ist wegen seiner Leichtigkeit, Größe und einfachen Installation angezeigt. Darüber hinaus bietet Zero.3 im Vergleich zu Stein- oder Metallmaterialien und Putzoberflächen eine höhere Beständigkeit gegen Witterungseinflüsse, Smog, Chemikalien, Flecken und Graffiti, und hat hervorragende Eigenschaften in Bezug auf die Langlebigkeit (Alterungsbeständigkeit, Licht- und Frosteinwirkung).

Veredelung von Außenverkleidungsplatten für Bauwerke und Fertighäuser

Zero.3 ist aufgrund seiner technischen Eigenschaften, seiner Leichtigkeit und seines großen Formats die optimale Lösung.

Zero.3 est idéal pour la construction d'édifices à très faible consommation énergétique ; celles-ci sont les applications dans lesquelles Zero.3 est le matériau optimal :

Finition de sols et revêtements

Zero.3 est un produit réalisé avec des matières premières naturelles qui ne contiennent pas de substances synthétiques, qui offre des prestations de sécurité (résistance au feu), nettoyabilité et durabilité nettement supérieures par rapport au bois et à la moquette.

Installations de chauffage au sol

Zero.3 offre des prestations d'excellence car il favorise l'optimisation du système complet avec des températures plus basses que l'eau et, par conséquent, l'économie d'énergie de toute l'installation (grâce à sa faible épaisseur et à la conductivité thermique supérieure par rapport au bois qui est un matériau isolant).

Finitions de surface de revêtements avec murs manteau et façades ventilées

L'utilisation de Zero.3 est indiqué pour sa légèreté, le grand format et la facilité d'installation. De plus, par rapport aux matériaux en pierre ou métalliques et par rapport aux finitions à enduit, Zero.3 offre sûrement une plus grande résistance aux agents atmosphériques, à la pollution, aux agents chimiques, aux taches et aux graffitis, et des caractéristiques d'excellence en ce qui concerne la durabilité dans le temps (résistance au vieillissement, à l'action de la lumière et du gel).

Finition de panneaux de tamponnement extérieur pour structures et maisons préfabriquées

Zero.3 est la solution optimale grâce à ses caractéristiques techniques, sa légèreté et son grand format.

Certificazioni di sistema

Management system certifications_Qualitätssystem Zertifizierungen_
Certifications du système de gestion

Di seguito sono riportate le certificazioni di sistema ottenute da Panariagroup per i suoi stabilimenti, le divisioni commerciali e le funzioni di servizio, a testimonianza dell'impegno del Gruppo verso le questioni etiche, ambientali, di sicurezza e qualità. Per maggiori dettagli e per scaricare i certificati vi invitiamo a consultare il nostro sito: panaria.it

Below are the system certifications obtained by Panariagroup for its factories, commercial divisions and service departments, testifying to the Group's commitment to ethical, environmental, safety and quality issues.

For further details and to download the certificates please visit our website: panaria.it

Im Folgenden sind die Zertifizierungen der Fertigungsstätten, Geschäftsbereiche und Serviceleistungen von Panariagroup aufgeführt, die das Engagement der Gruppe in Fragen der Ethik, des Umweltschutzes, der Arbeitssicherheit und der Qualität bezeugen. Bitte besuchen Sie unsere Website für weitere Information, und um die Zertifikate herunterzuladen: panaria.it

Vous trouverez ci-dessous les certifications système obtenues par Panariagroup pour ses établissements, les divisions commerciales et les fonctions de service, témoignant de l'engagement du Groupe en matière d'éthique, d'environnement, de sécurité et de qualité. Pour plus de détails et pour télécharger les certificats, nous vous invitons à consulter notre site Web : panaria.it

CERTIFICAZIONE CERTIFICATION BESCHEINIGUNG CERTIFICATIONS	DESCRIZIONE	DESCRIPTION	BESCHREIBUNG	DESCRIPTION
 UNI EN ISO 9001:2015	Ai sensi della Certificazione ISO 9001, tutte le fasi del processo produttivo, a partire dall'arrivo delle materie prime fino alla scelta e confezionamento del prodotto finito, vengono opportunamente verificate da personale esperto attraverso accurate controlli di qualità. Il sistema qualità dei siti produttivi Panariagroup viene verificato con frequenza annuale da un ente certificatore esterno attraverso accurate visite ispettive.	In accordance with the ISO 9001 certification, every step in the production process, from the arrival of the raw material to the packaging of the finished product, is verified by experienced personnel through accurate quality control. The quality of the Panariagroup production sites is audited yearly by an external agency through thorough inspections.	In Übereinstimmung mit der Zertifizierung ISO 9001, werden alle Schritte des Produktionsprozesses, von der Anlieferung der Rohstoffe bis zur Auswahl und Verpackung des Endprodukts von Fachpersonal durch eine sorgfältige Qualitätskontrolle überwacht. Das Qualitätssystem der Produktionsstätten der Panariagroup wird jährlich von einer externen Zertifizierungsstelle durch genaue Kontrollen überprüft.	Conformément à la Certification ISO 9001, toutes les phases du processus de production, à partir de l'arrivée des matières premières jusqu'à la sélection et le conditionnement du produit fini, sont adéquatement vérifiées par du personnel qualifié qui effectue des contrôles de qualité approfondis. Le système qualité des sites de production Panariagroup est vérifié tous les ans par un organisme de certification externe au moyen de visites d'inspection approfondies.
 UNI EN ISO 14001:2015	Ai fini della Certificazione ISO 14001 tutti gli aspetti ambientali inerenti all'attività di produzione di piastrelle vengono costantemente controllati, garantendo l'utilizzo delle migliori tecnologie presenti sul mercato per ridurre al minimo gli impatti ambientali generati. Il sistema ambientale dei siti produttivi Panariagroup viene verificato con frequenza annuale da un ente certificatore esterno attraverso accurate visite ispettive.	In accordance with the ISO 14001 certification, all the environmental aspects concerned in the production of the tiles are constantly monitored, guaranteeing the use of the best technologies on the market in order to reduce the environmental impact. The environmental system of the Panariagroup production sites is audited yearly by an external agency through thorough inspections.	Im Hinblick auf die ISO 14001-Zertifizierung werden alle mit der Herstellung von Fliesen zusammenhängenden Umweltaspekte kontinuierlich überwacht und der Einsatz der besten Technologien auf dem Markt gewährleistet, um die Umweltbelastung auf ein Minimum zu reduzieren. Das Umweltschutzsystem der Produktionsstätten der Panariagroup wird jährlich von einer externen Zertifizierungsstelle durch genaue Kontrollen überprüft.	La Certification ISO 14001 impose un contrôle constant de tous les aspects environnementaux relatifs à l'activité de production de carreaux, garantissant l'utilisation des meilleures technologies présentes sur le marché afin de réduire au minimum l'impacte environnementale. Le système environnemental des sites de production Panariagroup est vérifié tous les ans par un organisme de certification externe au moyen de visites d'inspection approfondies.
	Il sistema comunitario di ecogestione e audit EMAS per le organizzazioni richiede la creazione di un Sistema di Gestione Ambientale basato sul continuo miglioramento delle proprie prestazioni. Il sistema si fonda sulla creazione di un rapporto di collaborazione e fiducia con i dipendenti, con le istituzioni del territorio e con il pubblico. La Dichiarazione Ambientale è il documento finale di tale processo.	The EU EMAS Eco-Management and Audit Scheme for organisations requires the creation of a complete Environmental Management System based on constant improvement. The system aims to create cooperation and build trust between the company and the employees, local authorities and public. The Environmental Declaration is the final document of this process.	Das EU-Umweltmanagement- und -Auditsystem EMAS für Unternehmen verlangt die Einführung eines Umweltmanagementsystems, das auf der kontinuierlichen Verbesserung seiner eigenen Umwelleistung beruht. Das System basiert auf der Schaffung einer Beziehung der Zusammenarbeit und des Vertrauens mit den Mitarbeitern, den lokalen Behörden und der Öffentlichkeit. Die Umwelterklärung ist das abschließende Dokument dieses Prozesses.	Le système communautaire de management environnemental et d'audit EMAS pour les organisations exige la création d'un Système de Gestion Environnemental basé sur l'amélioration constante des prestations. Le système est fondé sur la création d'un rapport de collaboration et de confiance avec les employés, les institutions du territoire et le public. La Déclaration Environnementale est le document final de ce processus.

Certificazioni di prodotto

Product certifications_Produktzertifizierungen_Certifications de produits

Di seguito sono riportate le certificazioni di prodotto ottenute da Panaria a testimonianza della massima attenzione e sensibilità verso le questioni etiche, ambientali e di sicurezza e qualità. Per maggiori dettagli e per scaricare i certificati vi invitiamo a consultare il nostro sito: panaria.it

Below are the certifications obtained by Panaria attesting to the utmost attention and sensitivity shown towards ethical, environmental, safety and quality issues.

For more details and to download the certificates, please visit our website: panaria.it

Im Folgenden finden Sie die Zertifizierungen, die Panaria als Zeichen der Anerkennung für die großen Bemühungen und die Sorgfalt im Umgang mit ethischen, ökologischen, Sicherheits- und Qualitätsfragen ausgestellt wurden. Für weitere Informationen und um die Zertifikate herunterzuladen, besuchen Sie bitte unsere Website: panaria.it

Ci-après, les certifications obtenues par Panaria qui témoignent de la plus haute attention et sensibilité envers les questions éthiques, environnementales, de sécurité et de qualité.

Pour plus de détails et pour télécharger les certificats, nous vous invitons à consulter notre nouveau site : panaria.it

CERTIFICAZIONE CERTIFICATION BESCHEINIGUNG CERTIFICATIONS	DESCRIZIONE	DESCRIPTION	BESCHREIBUNG	DESCRIPTION
	UPEC è una certificazione di prodotto rilasciata dall'istituto francese CSTB che verifica l'idoneità tecnica dei prodotti di prima scelta in relazione al tipo di destinazione d'uso.	UPEC is a product certification issued by the French institute CSTB that verifies the technical suitability of first choice products in relation to their intended use.	UPEC ist eine Produktzertifizierung, die von dem französischen Institut CSTB ausgestellt wird und die technische Eignung von Produkten erster Wahl im Hinblick auf ihren Verwendungszweck prüft.	L'UPEC est une certification de produit délivrée par l'institut français CSTB qui vérifie l'adéquation technique des produits de premier choix par rapport au type d'usage prévu.
	La marcatura CE è la certificazione di sicurezza del prodotto richiesta dall'Unione Europea e ha lo scopo di salvaguardare la salute delle persone.	The CE mark is a safety certification required by the European Union with the intention of safeguarding health and safety.	Die CE-Kennzeichnung ist die von der Europäischen Union geforderte Zertifizierung der Produktsicherheit und dient dem Schutz der Gesundheit der Menschen.	La marque CE est la certification de sécurité des produits demandée par l'Union Européenne ayant comme objectif la protection et la santé des personnes.
	Il marchio KEY-MARK e il marchio Certiquality-UNI attestano che i prodotti certificati sono conformi alle normative europee per le piastrelle ceramiche.	The KEY-MARK and the Certiquality-UNI marks confirm that the certified products are compliant with the EU laws regarding ceramic tiles.	Die Kennzeichnung KEY-MARK und die Kennzeichnung Certiquality-UNI bescheinigen, dass die zertifizierten Produkte den Europäischen Richtlinien für Keramikfliesen entsprechen.	Le Label KEY-MARK et le Label Certiquality-UNI attestent que les produits certifiés sont conformes aux normes européennes pour les carreaux céramiques.
	La Dichiarazione Ambientale di Prodotto (EPD) comunica in modo trasparente le prestazioni ambientali del gres porcellanato Panaria basandosi sull'analisi del ciclo di vita (LCA). I prodotti Panaria possiedono EPD specifica di tipo III, certificata da ente terzo indipendente secondo le normative ISO 14025 e EN 15804 (PCR di riferimento). I Prodotti certificati EPD sono richiesti dai principali sistemi di certificazione degli edifici quali LEED (internazionale), BREEAM (Inghilterra), HQE (Francia) e DGNB (Germania), nonché in schemi legislativi in Italia (requisiti per appalti pubblici sostenibili). È una certificazione volontaria, che valorizza ancor più i materiali Panaria perché prodotti secondo i migliori standard di sostenibilità e responsabilità.	The Environmental Product Declaration (EPD) is a document that communicates transparent information about the environmental characteristics of Panaria porcelain tiles through its Life Cycle Assessment (LCA). Panaria products have a type III specific EPD. This is certified by an independent third party according to ISO 14025 and EN 15804 standards (applicable PCR). EPD certified products are required by the main construction certifying bodies such as LEED (international), BREEAM (England), HQE (France), and DGNB (Germany), as well as the legislative frameworks in Italy (requisites for sustainable public contracts). It is a voluntary certification that gives additional value to Panaria products because they are manufactured according to the highest standards of sustainability and responsibility.	Die Umwelt-Produktdeklaration (EPD) macht die Umweltleistung des Feinsteinzeugs von Panaria auf der Grundlage der "Lebensdaueranalyse" (LCA) transparent. Die Produkte Panaria verfügen über eine EPD vom Typ III, die von einem unabhängigen Dritten nach den Normen ISO 14025 und EN 15804 (Referenz-PCR) zertifiziert wurde. EPD-zertifizierte Produkte werden von den wichtigsten Gebäudezertifizierungssystemen verlangt, wie z.B. LEED (International), BREEAM (England), HQE (Frankreich) und DGNB (Deutschland), sowie von den gesetzlichen Regelungen in Italien (Anforderungen an ein nachhaltiges öffentliches Auftragswesen). Es handelt sich um eine freiwillige Zertifizierung, die den Wert der Materialien von Panaria zusätzlich unterstreicht, da sie nach den höchsten Anforderungen an Nachhaltigkeit und Verantwortung hergestellt werden.	La Déclaration Environnementale Produit (DEP) communique de manière transparente les performances environnementales du grès cérame Panaria en se basant sur l'analyse du cycle de vie (ACV). Les produits Panaria possèdent la déclaration environnementale (DEP) de type III, certifiée par un organisme tiers indépendant conformément aux normes ISO 14025 et EN 15804 (PCR de référence). Les produits certifiés DEP sont requis par les principaux organismes de certification pour la construction comme LEED (pour l'international), BREEAM (Angleterre), HQE (France) et DGNB (Allemagne), et par les cadres législatifs prévus en Italie (conditions pour participer aux marchés publics durables). Cette certification est une démarche volontaire, et vise à apporter une valeur supplémentaire aux matériaux Panaria, fabriqués de manière responsable et selon les meilleurs standards écologiques.
	I prodotti Panaria sono conformi alla norma internazionale ISO 17889-1 "Sustainability issues for ceramic tiling systems", che stabilisce i criteri di sostenibilità per le superfici ceramiche con l'obiettivo di fornire a professionisti della progettazione, appaltatori e consumatori una norma verificabile e valida a livello internazionale per qualificare il prodotto secondo criteri di sostenibilità economica, ambientale e sociale. La norma prevede trentotto parametri a cui è obbligatorio essere conformi e che determinano un punteggio specifico per ogni prodotto, confrontandolo con valori di riferimento. Solo le piastrelle in ceramica che raggiungono un punteggio minimo di 117,5 possono ottenere la conformità alla norma ISO 17889-1.	The Panaria products comply with the international standard ISO 17889-1 "Sustainability issues for ceramic tiling systems", that establishes the sustainability criteria for ceramic surfaces with the goal of providing design professionals, contractors and consumers a standard that is verifiable and valid at the international level for qualifying the product according to economic, environmental and social sustainability. The standard provides thirty-eight parameters to which compliance is mandatory, and which determine a specific score for each product, comparing it with reference values. Only ceramic tiles that achieve a minimum score of 117.5 can obtain compliance with standard ISO 17889-1.	Die Produkte von Panaria entsprechen der internationalen Norm ISO 17889-1 "Sustainability issues for ceramic tiling systems", welche die Nachhaltigkeitskriterien für Keramikoberflächen festlegt, um Planern, Bauunternehmern und Verbrauchern eine überprüfbare und international gültige Norm zur Qualifikation des Produkts anhand von wirtschaftlichen, ökologischen und sozialen Nachhaltigkeitskriterien zur Verfügung zu stellen. Die Norm sieht achtunddreißig Parameter vor, die zwingend eingehalten werden müssen und für jedes Produkt eine bestimmte Punktzahl festlegen, die auf der Grundlage eines Vergleichs mit Referenzwerten vergeben wird. Nur Keramikfliesen, die eine Mindestpunktzahl von 117,5 erreichen, können die Zertifizierung nach ISO 17889-1 erhalten.	Les produits Panaria sont conformes à la norme internationale ISO 17889-1 "Sustainability issues for ceramic tiling systems", qui établit les critères de durabilité pour les surfaces en céramique en vue de fournir aux concepteurs professionnels, aux entrepreneurs et aux consommateurs une norme vérifiable et valide au niveau international permettant de qualifier les produits suivant des critères de durabilité économique, environnementale et sociale. La norme prévoit trente-huit paramètres auxquels il faut absolument se conformer car ils permettent d'obtenir une note spécifique à chaque produit, à comparer avec des valeurs de référence. Seuls les carreaux en céramique vantant une note minimale de 117,5 peuvent être déclarés conforme à la norme ISO 17889-1.

Certificazioni di prodotto

Product certifications_Produktzertifizierungen_Certifications de produits

Di seguito riportate le certificazioni ottenute da Panaria a testimonianza della massima attenzione e sensibilità verso le questioni etiche, ambientali e di sicurezza e qualità.

Per maggiori dettagli e per scaricare i certificati vi invitiamo a consultare il nostro sito: panaria.it

Below are the certifications obtained by Panaria attesting to the utmost attention and sensitivity shown towards ethical, environmental, safety and quality issues.

For more details and to download the certificates, please visit our website: panaria.it

Im Folgenden finden Sie die Zertifizierungen, die Panaria als Zeichen der Anerkennung für die großen Bemühungen und die Sorgfalt im Umgang mit ethischen, ökologischen, Sicherheits- und Qualitätsfragen ausgestellt wurden.

Für weitere Informationen und um die Zertifikate herunterzuladen, besuchen Sie bitte unsere Website: panaria.it

Ci-après, les certifications obtenues par Panaria qui témoignent de la plus haute attention et sensibilité envers les questions éthiques, environnementales, de sécurité et de qualité.

Pour plus de détails et pour télécharger les certificats, nous vous invitons à consulter notre nouveau site : panaria.it

CERTIFICAZIONE CERTIFICATION BESCHEINIGUNG CERTIFICATIONS	DESCRIZIONE	DESCRIPTION	BESCHREIBUNG	DESCRIPTION
	Il marchio GREENGUARD certifica i prodotti che negli ambienti interni garantiscono i più elevati standard di qualità dell'aria. Tutte le collezioni Panaria in gres porcellanato e Zero.3 hanno ottenuto la certificazione GREENGUARD GOLD, cioè lo standard di UL con i limiti più stringenti di emissioni di VOC, e sono perciò in grado di assicurare la migliore salubrità alle persone che vivono e che abitano gli ambienti. Per questo possono essere impiegate in ambienti come scuole e strutture sanitarie, frequentate da soggetti sensibili come i bambini e gli anziani. GREENGUARD GOLD è una certificazione ampiamente riconosciuta e richiesta dai programmi di edilizia sostenibile e dai regolamenti di progettazione e costruzione in tutto il mondo, come il LEED (internazionale) e il BREEAM (UK).	GREENGUARD certifies products that guarantee the highest standards of air quality in indoor environments. All porcelain stoneware and Zero.3 Panaria collections have obtained GREENGUARD GOLD certification, i.e. the UL standard with the strictest VOC emission limits, and are therefore able to ensure that they are as healthy as possible for the people who use and inhabit these environments. They can therefore be used in environments such as schools and health facilities, attended by sensitive individuals such as children and the elderly. GREENGUARD GOLD is a widely recognised certification required by sustainable building programmes and design and construction regulations around the world, such as LEED (international) and BREEAM (UK).	Die Marke GREENGUARD zertifiziert die Produkte, die in Innenbereichen höchste Luftqualität garantieren. Alle Feinsteinzeug- und Zero.3-Kollektionen von Panaria besitzen die GREENGUARD GOLD-Zertifizierung, d.h. den UL-Standard mit den strengsten Grenzwerten für VOC-Emissionen, und gewährleisten somit die bestmögliche Gesundheitsverträglichkeit für die Menschen, die in den Räumen leben. Deshalb können sie in Umgebungen wie Schulen und Gesundheitseinrichtungen eingesetzt werden, die von empfindlichen Personen wie Kindern und älteren Menschen besucht werden. GREENGUARD GOLD ist eine weithin anerkannte Zertifizierung, die von nachhaltigen Bauprogrammen sowie weitweiten Planungs- und Baubewertungssystemen wie LEED (international) und BREEAM (Vereinigtes Königreich) verlangt wird.	La marque GREENGUARD certifie les produits qui garantissent les standards de qualité de l'air les plus élevés dans les environnements intérieurs. Toutes les collections Panaria en grès cérame et Zero.3 ont obtenu la certification GREENGUARD GOLD, qui est le standard de UL ayant les critères les plus sévères en matière d'émission de COV, et elles sont en mesure de garantir la meilleure salubrité aux personnes qui vivent et habitent dans ces environnements. Elles peuvent donc être utilisées dans des endroits comme les structures sanitaires, fréquentées par des individus sensibles tels que les enfants et les personnes âgées. GREENGUARD GOLD est une certification amplement reconnue et exigée par les programmes de construction durable et par les règlements de conception et construction du monde entier, comme le LEED (international) et le BREEAM (GB).
	Per gran parte dei suoi prodotti, Panaria ha ottenuto una certificazione relativa al contenuto di materiale riciclato pre-consumer. Questa caratteristica di eco-sostenibilità contribuisce all'ottenimento di crediti previsti da diversi standard edilizi internazionali.	For most of its products, Panaria has obtained certification for the content of pre-consumer recycled material. This eco-sustainability feature contributes to obtaining credits according to several international building standards.	Für die meisten seiner Produkte hat Panaria gewonnen eine Zertifizierung in Bezug auf den Inhalt des Materials recycelter Pre-Consumer. Dieses Merkmal der ökologischen Nachhaltigkeit trägt dazu bei, Kredite von unterschiedliche internationale Baunormen.	Pour la plupart de ses produits, Panaria a obtenu une certification liée à la teneur en matière recyclée pré-consumateur. Cette caractéristique de l'éco-durabilité contribue à l'obtention de crédits fournis par différentes normes de construction internationales.
	Panaria è membro del U.S. Green Building Council e del Green Building Council ITALIA, organizzazioni che promuovono la realizzazione di edifici ed opere nel rispetto dell'ambiente, della salute e del benessere delle persone che ci vivono e lavorano. Le schede LEED delle serie Panaria sono disponibili su richiesta, sia secondo il protocollo LEED V4 che secondo i protocolli del GBC Italia.	Panaria is a member of the U.S. Green Building Council and of the Green Building Council ITALIA. These organizations promote the construction of buildings and other works which respect the environment as well as the health and well-being of the people who live and work within them. The LEED data sheets for the Panaria series are available on request, both according to the LEED V4 protocol and to the GBC Italia protocols.	Panaria ist Mitglied des US-Green Building Councils und des Green Building Councils ITALIEN, beides Organisationen, die den Bau von Gebäuden und Bauwerken unter Berücksichtigung der Umwelt, Gesundheit und des Wohlbefindens der Menschen, die darin leben und arbeiten, fördern. Die LEED-Zertifikate für die Serie Panaria sind sowohl gemäß LEED V4 als auch gemäß den Protokollen von GBC Italia auf Anfrage erhältlich.	Panaria est membre de l'U.S. Green Building Council et du Green Building Council d'ITALIE, organisations qui promeuvent la réalisation d'édifices et d'ouvrages qui respectent l'environnement, la santé et le bien-être des personnes qui y vivent et y travaillent. Les fiches LEED des collections Panaria sont disponibles sur demande, aussi bien selon le protocole LEED V4 que selon les protocoles de GBC Italie.

Prodotti certificati

Certified products_Zertifizierte Produkte_Produts certifiés

SERIE SERIES SERIEN SERIES	 UPEC	 UPEC-F+ (Épaisseur 20 mm)	
ASSI D'ALPE			●
BIOARCH	●	●	●
BOREALIS	●	●	●
CONTEXT	●	●	●
CROSS WOOD			●
DISCOVER	●	●	●
ETERNITY			●
FRAME	●	●	●
KAIROS	●	●	●
MEMORY MOOD	●	●	●
NUANCE	●	●	●
PIERRE DES RÊVES	●	●	●
PIETRE DI FANES	●		●
PRIME STONE	●	●	●
THE PLACE			●
TRILOGY			●
URBANATURE	●	●	●
VIA MAESTRA	●	●	●

I classamenti UPEC dei singoli prodotti Panaria, compresi quelli delle nuove collezioni 2023, sono scaricabili dal sito www.cstb.fr o tramite il link <https://database.cstb.fr/> The UPEC classifications of the individual Panaria products, including those in the new 2023 collections, can be downloaded from www.cstb.fr or via the link <https://database.cstb.fr/> Die UPEC-Klassifizierungen der einzelnen Produkte von Panaria, darunter auch jene der neuen Kollektionen 2023, können von der Seite www.cstb.fr oder über den Link <https://database.cstb.fr/> heruntergeladen werden. Les classements UPEC de chaque produit Panaria, y compris ceux des nouvelles collections 2023, peuvent être téléchargés sur le site www.cstb.fr ou à travers le lien <https://database.cstb.fr/>

I certificati del contenuto di riciclato, compresi gli aggiornamenti 2023, sono scaricabili dal sito panaria.it alla sezione Download/Certificazioni Recycled content certificates, including the 2023 updates, can be downloaded from panaria.it in the Downloads/Certifications section. Die Zertifikate zum Recyclinganteil, darunter auch die Aktualisierungen 2023, können von der Seite panaria.it im Bereich Download/Zertifizierungen heruntergeladen werden. Les certificats sur la teneur en matière recyclée, y compris les mises à jour 2023, peuvent être téléchargés sur le site panaria.it dans la section Téléchargement / Certifications



UNI-CERTIQUALITY / KEY MARK

I certificati sono disponibili su richiesta

Certificates are available upon request

Die Zertifikate sind auf Anfrage erhältlich

Les certificats sont disponibles sur demande

Norme tecniche di riferimento

Technical standards_Technische Bezugsnormen_Normes techniques

Resistenza all'abrasione profonda

Deep abrasion resistance_Tiefenabriebfestigkeit_Résistance à l'abrasion profonde

ISO 10545-6

Le superfici non smaltate (UGL) sono sottoposte al metodo dell'abrasione profonda; questo test determina il volume di materiale che viene asportato dalla superficie con un disco abrasivo dopo 150 giri. Tanto minore è il volume asportato tanto più resistente è il materiale.

Unglazed (UGL) surfaces are subjected to the deep abrasion method; this test measures the volume of material removed from the surface with an abrasive disc after 150 rotation cycles. The lower the volume removed, the more resistant the material.

Unglasierte Oberflächen (UGL) werden einem Tiefenabriebfestigkeitstest unterzogen. Dieser Test bestimmt die Materialmenge, die mit einer Schleifscheibe nach 150 Umdrehungen von der Oberfläche abgetragen wird. Je geringer das abgetragene Materialmenge, um so beständiger ist das Material.

Les surfaces non émaillées (UGL) sont soumises à la méthode de l'abrasion profonde : ce test détermine le volume de matériau éliminé de la surface à l'aide d'un disque abrasif au bout de 150 tours. La résistance est d'autant plus importante que le volume de matériau éliminé est faible.



Resistenza al gelo

Frost resistance_Frostbeständigkeit_Résistance au gel

ISO 10545-12

I materiali ceramici posati in esterno subiscono danneggiamenti dovuti al gelo se possiedono una certa porosità. Quando l'acqua eventualmente assorbita ghiaccia, aumenta il proprio volume determinando forti sollecitazioni meccaniche interne che possono tradursi in distacchi di materiale sulla superficie. Le piastrelle Panaria sono ingelive quando, in virtù della porosità quasi nulla, superano sempre il test ISO 10545-12 che prevede 100 cicli gelo/disgelo tra -5°C e +5°C senza subire nessun danno.

Ceramic materials laid outdoors suffer frost damage if their porosity is above a certain level. When any water absorbed freezes, it increases in volume, generating strong internal mechanical stresses which may cause the material to detach from the underlying surface. Panaria tiles are frostproof thanks to their negligible porosity, they always comply with the ISO 10545-12 test comprising 100 frost/defrost cycles between -5°C and +5°C without suffering any damage.

Die in Außenbereichen verlegten keramischen Materialien werden durch Frost beschädigt, wenn sie eine bestimmte Porosität aufweisen. Wenn das mögliche aufgenommene Wasser vereist, dehnt es sich aus und führt zu inneren mechanischen Belastungen, die zur Ablösung von Material an der Oberfläche führen können. Die Fliesen Panaria sind frostbeständig, da sie so gut wie gar nicht porös sind, und daher den Test nach ISO 10545-12, der 100 Gefrier- und Tauzyklen zwischen -5°C und +5°C vorsieht, stets unbeschadet bestehen.

Les matériaux céramiques posés en extérieur subissent des dommages provoqués par le gel lorsqu'ils sont légèrement poreux. Lorsque l'eau éventuellement absorbée gèle, son volume augmente, ce qui a pour effet d'exercer de fortes sollicitations mécaniques internes qui peuvent se traduire par un détachement des carreaux de la surface de pose. Leur porosité étant quasi nulle, les carreaux Panaria sont ingélifs. Ils ont en effet réussi avec succès le test 10545-12 qui prévoit 100 cycles de gel/dégel entre -5°C et +5°C sans subir aucun dommage.



Resistenza all'attacco chimico

Chemical resistance_Chemikalienbeständigkeit_Résistance à l'attaque chimique

ISO 10545-13

Il metodo determina la resistenza chimica di piastrelle sia smaltate che non smaltate, utilizzando acidi (cloridrico, citrico, lattico) e basi (idrossido di potassio) a bassa (L) e ad alta (H) concentrazione. La classificazione viene effettuata come segue:
LA, HA: Resistente;
LB, HB: Modifica dell'aspetto della superficie;
LC, HC: Perdita parziale o completa della superficie originale.

This method measures the chemical resistance of both glazed and unglazed tiles, using acids (hydrochloric, citric and lactic) and bases (potassium hydroxide) at low (L) and high (H) concentration. The classification is as follows:
LA, HA: Resistant;
LB, HB: Changes in appearance of surface;
LC, HC: Partial or complete loss of original surface.

Die Methode bestimmt die Chemikalienbeständigkeit sowohl glasierter als auch unglasierter Fliesen, unter Verwendung von Säuren (Salzsäure, Zitronensäure, Milchsäure) und Laugen (Kaliumhydroxyd) in schwacher (L) und starker (H) Konzentration. Die Einstufung findet wie folgt statt:
LA, HA: Beständig;
LB, HB: Veränderung der Oberflächenoptik;
LC, HC: Teilweiser oder vollständiger Verlust der Originaloberfläche.

Cette méthode permet de mesurer la résistance chimique de carreaux émaillés et non-émaillés en utilisant différents acides (chlorhydrique, citrique et lactique) et des bases (hydroxyde de potassium) à basse (L) et haute (H) concentration. La classification est la suivante:
LA et HA: Résistant;
LB et HB: Modification de l'aspect de la surface;
LC et HC: Perte partielle ou totale de la surface d'origine.



Resistenza alle macchie

Stain resistance_Fleckenbeständigkeit_Résistance aux taches

ISO 10545-14

La superficie d'esercizio viene posta a contatto con tre agenti macchianti, olio d'oliva, soluzione alcolica di iodio e verde cromo in olio leggero; dopo 24 ore si procede alla pulizia.
Classe 5 - macchia rimossa con acqua calda corrente per 5 minuti;
Classe 4 - macchia rimossa mediante pulizia manuale con detergente debole;
Classe 3 - macchia rimossa mediante pulizia meccanica con detergente forte;
Classe 2 - macchia rimossa mediante immersione in idoneo solvente per 24 ore;
Classe 1 - macchia non rimossa.

The operating surface is subject to three staining agents, olive oil, iodine alcohol solution and chromium green in light oil; after 24 hours the surface is cleaned.
Class 5 - stain removed within 5 minutes under warm running water;
Class 4 - stain removed by manual cleaning with mild detergent;
Class 3 - stain removed by mechanical cleaning with strong detergent;
Class 2 - stain removed by dipping in suitable thinner for 24 hours;
Class 1 - stain not removed.

Die Arbeitsfläche wird drei färbenden Substanzen ausgesetzt, Olivenöl, alkoholischer Jodlösung und Grünchrom in Leichtöl und nach 24 Stunden gereinigt.
Klasse 5 - Der Fleck verschwindet nach 5-minütigen Abspülen mit warmem Wasser.
Klasse 4 - Der Fleck verschwindet nach einer Reinigung von Hand mit einem sanften Reinigungsmittel.
Klasse 3 - Der Fleck verschwindet nach einer mechanischen Reinigung mit einem starken Reinigungsmittel.
Klasse 2 - Der Fleck verschwindet nach einem 24-stündigen Tauchbad in einem geeigneten Lösungsmittel.
Klasse 1 - Der Fleck kann nicht entfernt werden.

La surface de travail est mise au contact de trois agents tachants, huile d'olive, solution alcoolique à base d'iode et vert de chrome dans une huile légère ; le nettoyage est effectué après 24 heures.
Classe 5 - tache enlevée à l'eau chaude courante (5 minutes);
Classe 4 - tache enlevée par nettoyage manuel avec un produit léger;
Classe 3 - tache enlevée par nettoyage mécanique avec un détergent fort;
Classe 2 - tache enlevée par immersion dans un solvant approprié pendant 24 heures;
Classe 1 - tache tenace.



Assorbimento d'acqua

Water absorption_Wasseraufnahmefähigkeit_Absorption d'eau

ISO 10545-3

La capacità di un materiale ceramico di assorbire acqua è in relazione alla sua porosità. I prodotti Panaria, grazie alle materie prime molto pregiate e alle avanzate tecnologie produttive, offrono sempre una compattezza eccezionale e conseguentemente valori minimi di porosità. L'assorbimento d'acqua rappresenta la quantità d'acqua assorbita dalla piastrella ceramica e viene espressa come % riferita alla massa.

A ceramic material's capacity to absorb water depends on its porosity. Thanks to the quality raw materials used and the state-of-the-art production technologies, Panaria products are always outstandingly compact, meaning that their porosity is negligible. Water absorption represents the quantity of water absorbed by the ceramic tile and is measured as a % of the weight

Die Wasseraufnahmefähigkeit eines keramischen Materials ist von seiner Porosität abhängig. Panaria Produkte weisen dank ihrer sehr hochwertigen Rohstoffe und ihrer fortschrittlichen Produktionstechniken stets eine ausgezeichnete kompakte Beschaffenheit und minimale Porosität auf. Der Wert drückt den Aufnahmeprozentsatz im Verhältnis zur Masse aus. Die Wasseraufnahme bezieht sich auf die von der Keramikfliese aufgenommene Wassermenge und wird in % im Verhältnis zur Masse ausgedrückt.

La capacité d'absorption d'eau d'un matériau céramique dépend de sa porosité. Grâce à la très haute qualité des matières premières utilisées et à des technologies de production avancées, les produits Panaria garantissent un degré de compacité exceptionnel synonyme de porosité minimale. L'absorption d'eau représente la quantité d'eau absorbée par le carreau céramique et est exprimée en % par rapport à la masse.



Norme tecniche di riferimento







Technical standards_Technische Bezugsnormen_Normes techniques

Resistenza allo scivolamento







Slip resistance_Rutschfestigkeit_Résistance au glissement

DIN EN 16165 - Annex B







Un operatore, indossando scarpe antinfortunistiche, cammina su di un piano ad inclinazione variabile rivestito di piastrelle da testare e cosparso con olio motore. Il piano viene progressivamente inclinato e l'angolo in corrispondenza del quale l'operatore inizia a scivolare determina la classificazione delle piastrelle, come riportato nella tabella seguente:

	$\alpha < 6^\circ$ = non classificate
	$6^\circ \leq \alpha \leq 10^\circ$ = R9
	$10^\circ < \alpha \leq 19^\circ$ = R10
	$19^\circ < \alpha \leq 27^\circ$ = R11
	$27^\circ < \alpha \leq 35^\circ$ = R12
	$\alpha > 35^\circ$ = R13







An operator, wearing safety shoes, walks on a variable inclination plane covered with tiles to be tested and sprinkled with motor oil. The plane is gradually tilted and the angle at which the operator starts to slide determines the classification of the tiles, as shown in the table below:

	$\alpha < 6^\circ$ = not classified
	$6^\circ \leq \alpha \leq 10^\circ$ = R9
	$10^\circ < \alpha \leq 19^\circ$ = R10
	$19^\circ < \alpha \leq 27^\circ$ = R11
	$27^\circ < \alpha \leq 35^\circ$ = R12
	$\alpha > 35^\circ$ = R13

Ein Prüfer läuft mit Sicherheitsschuhen über eine Fläche mit verstellbarer Neigung, die mit zu prüfenden, mit Motoröl benetzten Fliesen bedeckt ist. Die Fläche wird langsam geneigt und der Winkel, ab dem der Prüfer zu rutschen beginnt, bestimmt die Klassifizierung der Fliesen, wie in der nachstehenden Tabelle aufgezeigt:

	$\alpha < 6^\circ$ = nicht klassifizierbar
	$6^\circ \leq \alpha \leq 10^\circ$ = R9
	$10^\circ < \alpha \leq 19^\circ$ = R10
	$19^\circ < \alpha \leq 27^\circ$ = R11
	$27^\circ < \alpha \leq 35^\circ$ = R12
	$\alpha > 35^\circ$ = R13

Un opérateur, portant des chaussures de sécurité, marche sur une surface à inclinaison variable recouverte de carreaux à tester et aspergée d'huile moteur. La surface est progressivement inclinée et l'angle auquel l'opérateur commence à glisser détermine la classification des carreaux, comme indiqué dans le tableau suivant :

	$\alpha < 6^\circ$ = non classé
	$6^\circ \leq \alpha \leq 10^\circ$ = R9
	$10^\circ < \alpha \leq 19^\circ$ = R10
	$19^\circ < \alpha \leq 27^\circ$ = R11
	$27^\circ < \alpha \leq 35^\circ$ = R12
	$\alpha > 35^\circ$ = R13



Resistenza allo scivolamento

Slip resistance_Rutschfestigkeit_Résistance au glissement

ANSI A326.3

Coefficiente dinamico di attrito (DCOF): a volte chiamato coefficiente d'attrito. Questo è il rapporto tra la forza necessaria a mantenere una superficie già in movimento di scorrimento su un'altra ed il peso (o forza normale) di un oggetto. Lo standard nazionale ANSI A326.3:2021 richiede ai produttori di pavimento di fornire le classificazioni di utilizzo del prodotto in base alle loro proprietà di resistenza allo scivolamento, per aiutare i progettisti e gli utilizzatori finali nella selezione del materiale in funzione della destinazione d'uso, come riportato nella seguente tabella:

Classification	Reference Category
Interior, Dry	ID
Interior, Wet	IW
Interior, Wet Plus	IW+
Exterior, Wet	EW
Oils/Greases	O/G

Dynamic Coefficient of Friction (DCOF): sometimes called kinetic coefficient of friction. This is the ratio of the force necessary to keep a surface already in motion sliding over another divided by the weight (or normal force) of an object. The national standard ANSI A326.3:2021 requires flooring manufacturers to provide product usage classifications based on their slip resistance properties, to assist designers and end users in selecting material for intended use, as shown in the following table:



DIN EN 16165 - Annex A

Il metodo si prefigge di misurare l'idoneità delle piastrelle per la posa in ambienti dove si cammina a piedi scalzi (es. bordi piscine, docce, ecc.). Un operatore cammina a piedi scalzi su di un piano inclinabile sul quale sono posate le piastrelle in esame bagnate con una soluzione acquosa di sapone. Il piano viene via via inclinato, e l'angolo in corrispondenza del quale l'operatore inizia a scivolare determina la classificazione delle piastrelle, come riportato nella tabella seguente:

$\alpha < 12^\circ$	non classificate
$12^\circ \leq \alpha < 18^\circ$	A
$18^\circ \leq \alpha < 24^\circ$	B (A+B)
$\alpha \geq 24^\circ$	C (A+B+C)

This method aims to measure the tiles' suitability for laying in areas where people walk barefoot (e.g. edges of swimming-pools, showers, etc.). An operator walks barefoot over a tilting surface laid with the tiles for testing, wet with a soap and water solution. The surface is gradually tilted and the angle of tilt at which the operator starts to slip provides the tiles' rating, as shown in the table below.

$\alpha < 12^\circ$	not classified
$12^\circ \leq \alpha < 18^\circ$	A
$18^\circ \leq \alpha < 24^\circ$	B (A+B)
$\alpha \geq 24^\circ$	C (A+B+C)

Mit dieser Methode wird die Eignung der Fliesen für die Verlegung in Barfuß-Bereichen (z.B. Schwimmbeckenränder, Duschen, usw.) getestet. Eine Person läuft barfuß auf einer neigbaren Fläche, auf der die zu prüfenden Fliesen verlegt und mit einer Seifenwasserlösung benetzt sind. Die Fläche wird nach und nach geneigt und der Neigungswinkel, bei dem die Person zu rutschen beginnt, bestimmt die Klassifizierung der Fliesen, wie in der folgenden Tabelle aufgeführt:

$\alpha < 12^\circ$	nicht klassifizierbar
$12^\circ \leq \alpha < 18^\circ$	A
$18^\circ \leq \alpha < 24^\circ$	B (A+B)
$\alpha \geq 24^\circ$	C (A+B+C)

La méthode vise à mesurer la conformité des carreaux pour une pose sur des espaces au sein desquels l'on marche pieds nus (abords de piscine, douche, etc.). Un opérateur marche pieds nus sur un plan inclinable sur lequel sont posés des carreaux mouillés à l'aide d'une solution d'eau et de savon. Le plan est progressivement incliné et l'angle correspondant à l'inclinaison du plan au moment où l'opérateur commence à glisser détermine la classification des carreaux comme indiquée ci-dessous:

$\alpha < 12^\circ$	non classé
$12^\circ \leq \alpha < 18^\circ$	A
$18^\circ \leq \alpha < 24^\circ$	B (A+B)
$\alpha \geq 24^\circ$	C (A+B+C)

BCR TORTUS

Metodo inglese per la determinazione del coefficiente di attrito delle superfici in base alla resistenza opposta al trascinarsi di una apparecchiatura (Tortus) che viene fatta transitare sulla superficie stessa. Il metodo si basa, mediante un dispositivo mobile, di determinare il coefficiente di attrito che materiali standardizzati, quali gomma e cuoio, hanno in condizioni di asciutto o bagnato una volta a contatto con una determinata superficie da pavimentazione. Come già indicato sopra il "tortus test" il metodo di riferimento per la legislazione nazionale di cui al paragrafo 8.2.2 del D.M. 236/89 che nelle condizioni di Gomma asciutta e Cuoio bagnato prevede un coefficiente > 0,40. La macchina di prova per la rilevazione del coefficiente di attrito su superfici bagnate è il sistema Digital Sliptester Floor Slide Control FSC 2000, sistema computerizzato.

$\mu < 0,20$	Scivolosità pericolosa
$0,20 \leq \mu < 0,40$	Scivolosità eccessiva
$0,40 \leq \mu < 0,75$	Attrito soddisfacente
$\mu \geq 0,75$	Attrito eccellente

English method for finding the coefficient of friction of surfaces based on the resistance opposed to the movement of a tester instrument (Tortus) that crosses the surface to be tested. The method is based on the use of a mobile device to determine the coefficient of friction that standard materials, such as rubber and leather, have in wet or dry conditions when in contact with a certain floor covering material. As explained above, the "Tortus test" is the reference method for National legislation under paragraph 8.2.2 of Ministerial Decree 236/89, which envisages a coefficient equal to >0,40 in Dry Rubber and Wet Leather conditions. The friction coefficient testing machine for wet surfaces is the Digital Sliptester Floor Slide Control FSC 2000 system, which is computer-controlled.

$\mu < 0,20$	Dangerous sliding
$0,20 \leq \mu < 0,40$	Excessive sliding
$0,40 \leq \mu < 0,75$	Adequate friction
$\mu \geq 0,75$	Excellent friction

Englische Methode zur Bestimmung des Reibungskoeffizienten von Oberflächen auf der Grundlage des Schlepwwiderstandes eines Gerätes (Tortus), das über eine Oberfläche bewegt wird. Die Methode basiert darauf, mit Hilfe einer beweglichen Vorrichtung, den Reibungskoeffizienten zu ermitteln, den Standardmaterialien wie Gummi und Leder in trockenem und nassem Zustand in Kontakt mit einer bestimmten Fußbodenfläche aufweisen. Wie bereits oben erwähnt, ist der Tortus-Test die Grundlage für die nationale Gesetzgebung, gemäß Paragraph 8.2.2 des Ministerialerlasses 236/89, der für trockenes Gummi und nasses Leder einen Koeffizienten von > 0,40 vorsieht. Das Testgerät zur Ermittlung des Reibungskoeffizienten auf nassen Oberflächen ist das EDV-System Digital Sliptester Floor Slide Control FSC 2000.

$\mu < 0,20$	Gefährliche Rutschigkeit
$0,20 \leq \mu < 0,40$	Übermäßige Rutschigkeit
$0,40 \leq \mu < 0,75$	Mittlere Reibung
$\mu \geq 0,75$	Ausgezeichnete Reibung

Méthode anglaise pour la détermination du coefficient de frottement des surfaces en fonction de la résistance opposée au glissement d'un appareil (Tortus) sur la surface elle-même. Cette méthode consiste, par le biais d'un dispositif mobile, à déterminer le coefficient de frottement que des matières standardisées, telles que le caoutchouc et le cuir, possèdent sur des surfaces sèches ou mouillées en contact avec un sol bien précis. Ledit « Tortus Test », méthode de référence pour la législation nationale visée au paragraphe 8.2.2 du D.M. 236/89, prévoit dans des conditions de Caoutchouc sec et Cuir mouillé un coefficient > 0,40. Le mesurage du coefficient de frottement sur des surfaces mouillées est obtenu au moyen du système informatisé Digital Sliptester Floor Slide Control FSC 2000.

$\mu < 0,20$	Glissance dangereuse
$0,20 \leq \mu < 0,40$	Glissance excessive
$0,40 \leq \mu < 0,75$	Frottement satisfaisant
$\mu \geq 0,75$	Frottement excellent

AS/NZS 4586 – APPENDICE A / APPENDIX A

La prova del pendolo bagnato per la misurazione della resistenza allo scivolamento (AS/NZS 4586 Appendice A) è generalmente eseguita utilizzando uno strumento di prova a pendolo Wessex oppure Munro - Stanley London. Il dispositivo a pendolo è portatile ed è composto da un piede appesantito e da un cursore di prova che oscilla verso il basso e scorre su una superficie bagnata con acqua. Il piede comprende un cursore in gomma con carica a molla che esercita una forza prestabilita sul campione mentre scivola sulla superficie. Gli esiti della prova sono espressi sotto forma di British Pendulum Number (BPN) e classificati secondo la norma AS/NZS 4586, come indicato nella tabella seguente. La AS/NZS 4586 classifica la superficie sulla base del valore BPN medio, mentre la norma australiana per prove di resistenza allo scivolamento AS/NZS 4663 esprime l'esito come BPN. La AS/NZS 4663 fornisce inoltre una stima del contributo teorico del pavimento al rischio di scivolamento in presenza di acqua, come indicato di seguito:

Valore medio per prova a pendolo BPM Pendulum mean BPM		Classificazione AS/NZS 4586 AS/NZS 4586 Classification	AS/NZS 4663 Contributo teorico del pavimento al rischio di scivolamento sul bagnato AS/NZS 4663 Notional contribution of the floor surface to the risk of slipping when wet	AS/NZS 4663 Notional contribution of the floor surface to the risk of slipping when wet
Four S	TRL			
> 54	> 44	V (P5:2013)		Molto basso / Very low
45 - 54	40 - 44	W (P4:2013)		Basso / Low
35 - 44	-	X (P3:2013)		Moderato / Moderate
25 - 34	-	Y (P2:2013)		Alto / High
< 25	-	Z (P1:2013)		Molto alto / Very high

Mentre si possono utilizzare 2 tipi di materiale per il cursore in gomma, la suola da scarpa simulata standard ('Four S') è generalmente accettata come materiale per valutare la resistenza allo scivolamento per persone che indossano calzature adeguate. Si utilizza prevalentemente gomma TRL (Transport Research Laboratory) per superfici ad alta resistenza allo scivolamento o superfici strutturate. Le attività di ricerca hanno dimostrato che la gomma TRL fornisce un'indicazione più affidabile della resistenza allo scivolamento a piedi nudi, data la natura più morbida e cedevole del materiale che è più simile alla pelle umana rispetto alla gomma Four S.

While there are 2 rubber slider materials that may be used, Four S (simulated standard shoe sole) is generally accepted as the material to assess the slip resistance for people wearing suitable footwear. TRL (Transport Research Laboratory) rubber is predominantly used for highly slip resistant and rough surfaces. Research has indicated that TRL rubber may provide a better indication of barefoot slip resistance due to the softer yielding nature of the material, being more comparable to human skin than Four S rubber.

UNE 41901 EX

Prova del pendolo secondo la normativa UNE 41901 EX CLASSIFICAZIONE DEI PAVIMENTI secondo Documento Básico SUA :2019 (Seguridad de utilización y accesibilidad):

Scivolosità (R _d)	Classe
R _d ≤ 15	0
15 < R _d ≤ 35	1
35 < R _d ≤ 45	2
R _d > 45	3

Classe attribuibile alle pavimentazioni in funzione della loro collocazione

Collocazione e caratteristiche della pavimentazione	Classe
Zone interne asciutte	1
- superfici con pendenza minore del 6% - superfici con pendenza maggiore o uguale al 6% e scale	2
Zone interne umide, come gli ingressi agli edifici da spazi esterni ⁽¹⁾ , terrazze coperte, guardaroba, docce, bagni, spogliatoi, cucine, etc.	2
- superfici con pendenza minore del 6% - superfici con pendenza maggiore o uguale al 6% e scale	3
Zone interne dove, oltre l'acqua, si possono trovare agenti (grassi, lubrificanti, etc.) che riducono la resistenza allo scivolamento, come cucine industriali, macelli, parcheggi, zone di uso industriale, etc.	3
Zone esterne. Docce. Piscine ⁽²⁾	3

(1) Fanno eccezione gli accessi diretti a zone di uso limitato.
(2) In areas dove si prevede il passaggio di utenti scalzi e sul fondo delle vasche nella zona in cui la profondità non ecceda i 1,50 m.

Pendulum test according to the UNE 41901 EX standard CLASSIFICATION OF FLOORS according to the record Básico SUA :2019 (Seguridad de utilización y accesibilidad):

Slip resistance coefficient (R _d)	Class
R _d ≤ 15	0
15 < R _d ≤ 35	1
35 < R _d ≤ 45	2
R _d > 45	3

Class required for floors according to their location

Location and characteristics of the floor	Class
Dry interior areas	1
- surfaces with a slope less than 6% - surfaces with a slope equal to or greater than 6% and stairs	2
Humid interior areas, such as entrances to buildings from the exterior ⁽¹⁾ , covered terraces, changing rooms, showers, bathrooms, toilets, kitchens, etc.	2
- surfaces with a slope less than 6% - surfaces with a slope equal to or greater than 6% and stairs	3
Interior areas, which in addition to water, may include agents (greases, lubricants, etc.) that may reduce slip resistance, such as industrial kitchens, slaughterhouses, car parks, industrial use areas, etc.	3
Exterior areas. Showers. Swimming pools ⁽²⁾	3

(1) Except in the case of direct entries to areas of restricted use.
(2) In areas provided for barefoot users and in the bottom of pools, in areas in which the depth does not exceed 1.5 m.

Ensayo del péndulo según la norma UNE 41901 EX

CLASIFICACIÓN DE LOS SUELOS según el Documento Básico SUA :2019 (Seguridad de utilización y accesibilidad):

Resistencia al deslizamiento (R _d)	Clase
R _d ≤ 15	0
15 < R _d ≤ 35	1
35 < R _d ≤ 45	2
R _d > 45	3

Clase exigible a los suelos en función de su localización

Localización y características del suelo	Clase
Zonas interiores secas	1
- superficies con pendiente menor que el 6% - superficies con pendiente igual o mayor que el 6% y escaleras	2
Zonas interiores húmedas, tales como las entradas a los edificios desde el espacio exterior ⁽¹⁾ , terrazas cubiertas, vestuarios, duchas, baños, aseos, cocinas, etc.	2
- superficies con pendiente menor que el 6% - superficies con pendiente igual o mayor que el 6% y escaleras	3
Zonas interiores donde, además de agua, pueda haber agentes (grasas, lubricantes, etc.) que reduzcan la resistencia al deslizamiento, tales como cocinas industriales, mataderos, aparcamientos, zonas de uso industrial, etc.	3
Zonas exteriores. Duchas. Piscinas ⁽²⁾	3

(1) Excepto cuando se trate de accesos directos a zonas de uso restringido.
(2) En zonas previstas para usuarios descalzos y en el fondo de los vasos, en las zonas en las que la profundidad no exceda de 1,50 m.

Norme tecniche di riferimento

Technical standards_Technische Bezugsnormen_Normes techniques

Classe requisiti meccanici (carrabilità)

Mechanical requirements class (vehicular passage)_Klasse der mechanischen Anforderungen (Befahrbarkeit)_
Classe exigences mécanique (Dalles de voirie)



EN 1339

Le lastre per strade e coperture in cemento sono soggette a marcatura NF, la cui gestione è garantita da CERIB su incarico di AFNOR Certification.

- Classi di denominazione NF riconducibili all'uso

Corrispondono alle classi di requisiti della norma P 98-335 in merito al dimensionamento e alla realizzazione di pavimentazioni.

Les dalles de voirie et de toiture en béton font l'objet d'une marque NF dont la gestion est assurée par le CERIB par mandat de l'organisme de normalisation AFNOR.

- Classes d'appellation NF liées à l'usage

Elles correspondent aux classes d'exigences de la norme P 98-335 concernant le dimensionnement et la mise en oeuvre des chaussées.

Classe	S4	T7	T11	U14	U25	U30
Destinazione STRADA & COPERTURE Destination VOIRIE & TOITURE	Posa su sabbia o malta Pose sur sable ou mortier	Veicoli con carico per ruota < 0,6 t Véhicules de charge par roue < 0,6 t	Veicoli con carico per ruota < 0,9 t Véhicules de charge par roue < 0,9 t	Veicoli con carico per ruota < 2,5 t Véhicules de charge par roue < 2,5 t	Veicoli con carico per ruota ≤ 6,5 t Véhicules de charge par roue ≤ 6,5 t	
	Posa su sostegni Pose sur plots	/	Solo accesso pedonale Accès piétons exclusivement Uso moderato di piccola superficie (ad esempio, terrazze private) e altezza dei sostegni ≤ 15 cm Usage modéré sur petite surface (par ex: terrasses privées) et hauteur des plots ≤ 15 cm	Circolazione occasionale e a bassa velocità Circulation occasionnelle et à vitesse réduite Uso collettivo o pubblico Usage collectif ou public	Circolazione normale Circulation normale	Circolazione occasionale e a bassa velocità Circulation occasionnelle et à vitesse réduite

Notare che la designazione di tali classi è conforme alla norma europea che prevede una lettera per la resistenza alla flessione e un numero per il carico di rottura, pertanto per U25: U corrisponde a una resistenza alla flessione di 5,0 MPa e 25 a un carico di rottura di 25 kN.

A noter que l'appellation de ces classes est conforme à la norme européenne qui prévoit une lettre pour la résistance à la flexion et un nombre pour la charge de rupture, et donc pour U25 : U correspond à une résistance à la flexion de 5,0 MPa et 25 à une charge de rupture de 25 kN.

Sforzo di rottura (S)

Breaking strength (S)_Bruchwiderstand (S)_Charge de rupture (S)



EN 10545-4

Questo parametro serve per valutare la capacità della piastrella di sopportare carichi statici e dinamici quando è posta in esercizio. La norma considera la piastrella come una trave, posta su due rulli distanti tra loro, mentre al centro viene applicata una forza tramite un terzo rullo. Il carico di rottura è il peso che viene sopportato prima della rottura della piastrella. Il carico di rottura effettivo della piastrella in opera è notevolmente superiore a quello misurato in laboratorio.

This parameter is used to assess the ceramic tile's capacity to withstand static and dynamic loads after laying. The standard considers the tile as a beam, placed on two rollers a certain distance apart, while a third roller applies a force to its centre. The breaking strength is the weight the tile withstands before breaking. The actual breaking strength of a tile after laying is considerably higher than the value measured in the laboratory.

Dieser Parameter dient zur Bewertung der Fähigkeit der Fliesen, im verlegten Zustand statischen und dynamischen Belastungen standzuhalten. Die Norm betrachtet die Fliese als einen Balken, der auf zwei voneinander distanzieren Rollen liegt, während in der Mitte über eine dritte Rolle eine Kraft angelegt wird. Die Bruchlast ist das ausgehaltene Gewicht, bevor die Fliese bricht. Die tatsächliche Bruchfestigkeit der verlegten Fliese ist wesentlich höher als die im Labor gemessene Bruch-festigkeit.

Ce paramètre permet d'évaluer la capacité qu'a le carreau de supporter des charges statiques et dynamiques. La norme considère le carreau comme une poutre posée sur deux rouleaux distants l'un de l'autre alors qu'au centre du carreau est appliquée une force par l'intermédiaire d'un troisième rouleau. La charge de rupture est le poids supporté avant rupture du carreau. La charge de rupture effective du carreau après pose est nettement supérieure à celle mesurée en laboratoire.

ASTM C 648

Il metodo di prova consiste nell'appoggiare la piastrella sulle estremità di tre aste cilindriche oppure su tre cuscinetti a sfera per piastrelle, aventi un'area facciale pari a 6,25 pollici² (40 cm²) o area minore, disposte/i in modo da formare un triangolo equilatero. È pertanto applicata una forza di entità prestabilita al centro del supporto triangolare. Tale forza è mantenuta fino alla rottura del campione.

The test method consists in placing the tile on the ends of three cylindrical rods, or on three ball bearings for tiles having a facial area of 6.25 in² (40 cm²) or less, arranged in an equilateral triangle, and applying force at the centre of the triangular support, until the specimen breaks.

Die Testmethode besteht darin, die Fliese auf die Enden von drei Rundstäben oder, auf drei Fliesenkugellager mit einer Frontfläche von 6,25 Zoll² (40 cm²) oder weniger zu legen, die so angeordnet sind, dass sie ein gleichseitiges Dreieck bilden. Dann wird in der Mitte dieses dreieckigen Trägers eine zuvor festgelegte Kraft angelegt, bis die Fliesenprobe bricht.

La méthode d'essai consiste à poser le carreau sur les extrémités de trois tiges cylindriques ou sur trois roulements à billes pour les carreaux ayant une surface de 6,25 pouces² (40 cm²) ou inférieure, disposées/és de façon à former un triangle équilatéral. L'essai prévoit ensuite l'application d'une force prédéterminée au centre du support triangulaire, jusqu'à la rupture de l'échantillon.

Grado di stonalizzazione

Shade variation_Abtönungsgrad_Degré de variabilité chromatique



ANSI A137.1 - ANSI A137.3 (Zero.3)

Classificazione estetica e variazioni di tono. Il colore, la struttura e l'aspetto delle piastrelle possono variare secondo le specifiche del produttore definite per la particolare serie di piastrelle o linea di prodotto. Le seguenti designazioni di "classe estetica" sono fornite nella Tabella, affinché il produttore possa comunicare le caratteristiche estetiche di un particolare prodotto.

Aesthetic classification and shade variations. Tiles may vary in color, texture, or appearance according to the manufacturer's design for that particular tile series or product line. The following aesthetic class designations have been provided in the Table, so that the manufacturer may describe the aesthetic characteristics of a particular tile product.

Optische Klassifizierung und Tonvariationen. Die Farbe, die Struktur und das Aussehen der Fliesen können aufgrund der für die besondere Fliesenserie oder Produktreihe festgelegten Spezifikationen seitens des Herstellers variieren. Die folgenden Bezeichnungen der „Kategorie“ sind in der Tabelle angegeben, damit der Hersteller die ästhetischen Merkmale eines bestimmten Produkts vermitteln kann.

Classification esthétique et variations de tonalité. La couleur, la structure et l'aspect des carreaux peuvent varier en fonction des spécifications du producteur définies pour la série de carreaux ou la ligne de produit spécifique. Les désignations de « classe esthétique » suivantes sont fournies dans le Tableau pour permettre au producteur de communiquer les caractéristiques esthétiques d'un produit particulier.

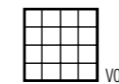

V0

NULLA

Aspetto molto uniforme. I pezzi della stessa variante di colore sono molto uniformi.

NONE

Very uniform appearance. Pieces of the same colour variant are very uniform.

NICHTIG

Sehr gleichmäßiges Erscheinungsbild. Die Fliesen der gleichen Farbvariante sind sehr gleichmäßig.

NUL

Aspect très uniforme. Les pièces de la même variante de couleur sont très uniformes.

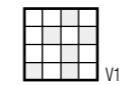

V1

LIEVE

Aspetto uniforme. Le differenze fra i pezzi di un lotto di produzione sono minime.

MINOR

Uniform appearance. Differences among pieces from the same production batch are minimal.

LEICHT

Gleichmäßiges Erscheinungsbild. Die Unterschiede zwischen den Fliesen eines Produktionsloses sind minimal.

LÉGER

Aspect uniforme. Les différences entre les pièces d'un même lot de production sont minimales.

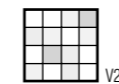

V2

BASSO

Variazioni minime. Differenze chiaramente visibili nella struttura e/o nel design fra pezzi di colori simili.

LOW

Slight variation. Clearly distinguishable differences in texture and/or pattern within similar colors.

GERING

Minimale Abweichungen. Deutlich sichtbare Unterschiede in der Struktur und/oder im Design zwischen Fliesen ähnlicher Farbe.

FAIBLE

Variations minimales. Différences clairement visibles au niveau de la structure et/ou du design entre les pièces caractérisées par des couleurs similaires.

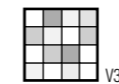

V3

MEDIO

Variazioni moderate. Benché i colori e la struttura di un singolo pezzo possano essere identificativi dei colori e della struttura degli altri pezzi, la variazione di colore e di struttura di ciascun pezzo può variare in maniera significativa. Si consiglia di esaminare la gamma prima dell'eventuale scelta.

MEDIUM

Moderate variation. While the colors and or texture present on a single piece of tile will be indicative of the colors and or texture to be expected on the other tiles, the variation of colors and or texture on each piece may vary significantly. It is recommended that the range be viewed before selection.

MITTEL

Mäßige Abweichungen. Obwohl die Farben und die Struktur einer einzelnen Fliese kennzeichnend für die Farben und die Struktur der anderen Fliesen sein können, können die Farbe und die Struktur jeder einzelnen Fliese beträchtliche Abweichungen aufweisen. Es empfiehlt sich vor einer möglichen Auswahl die Produktpalette zu überprüfen.

MOYEN

Variations modérées. Même si les couleurs et la structure d'une seule pièce peuvent identifier les couleurs et les structures des autres pièces, la variation de la couleur et de la structure de chaque pièce peut être significative. Il est conseillé d'examiner la gamme avant de choisir.

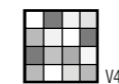

V4

ALTO

Variazioni sostanziali. Differenze casuali di colore o struttura da piastrella e piastrella, di conseguenza una piastrella può avere colori e/o struttura totalmente diversi da altre piastrelle. Pertanto, il risultato finale sarà unico e non ripetibile. Si consiglia di esaminare la gamma prima dell'eventuale scelta.

MAJOR

Substantial variation. Random color and or texture differences from tile to tile, so that one tile may have totally different colors and or texture from that on other tiles. Thus, the final installation will be unique. It is recommended that the range be viewed before selection.

STARK

Starke Abweichungen. Zufällige Farb- oder Strukturunterschiede zwischen den einzelnen Fliesen, folglich kann sich die Farbe und/oder Struktur einer Fliese vollkommen von den anderen Fliesen unterscheiden, und das Endergebnis ist daher einmalig und nicht wiederholbar. Es empfiehlt sich vor einer möglichen Auswahl die Produktpalette zu überprüfen.

ÉLEVÉ















Variations importantes. Différences aléatoires au niveau de la couleur ou de la structure d'un carreau à l'autre. Un carreau peut ainsi présenter des couleurs et/ou une structure totalement différentes de celles d'autres carreaux. Le résultat final sera donc unique et non reproductible. Il est conseillé d'examiner la gamme avant de choisir.

Caratteristiche tecniche

Technical features_Technische Eigenschaften_Caractéristiques techniques

Zero.3 GRES PORCELLANATO LAMINATO_LAMINATED PORCELAIN STONWARE_LAMINIERTES FEINSTEINZEUG_GRÈS CÉRAME LAMINÉ















Conforme_according to_Gemäß_conforme: ISO 13006-G - EN 14411-G Gruppo/Group Bla-UGL

CARATTERISTICHE TECNICHE TECHNICAL FEATURES TECHNISCHE EIGENSCHAFTEN CARACTÉRISTIQUES TECHNIQUES	METODO DI PROVA TEST METHOD PRÜFMETHODE MÉTHODE D'ESSAI	REQUISITI PRESCRITTI REQUIRED VALUES VORGEGEBENE ANFORDERUNGEN VALEURS REQUISES ISO 13006-G - EN 14411-G Gruppo/Group Bla-UGL	VALORI MEDI AVERAGE VALUES DURCHSCHNITTLICHE WERTE VALEURS MOYENNES Zero.3 3plus* - 5plus*	VALORI MEDI AVERAGE VALUES DURCHSCHNITTLICHE WERTE VALEURS MOYENNES Zero.3 6mm
 ASSORBIMENTO D'ACQUA WATER ABSORPTION WASSERAUFNAHMEFÄHIGKEIT ABSORPTION D'EAU	ISO 10545-3	≤ 0,5%	0,1% (1)	0,1%
 RESISTENZA ALLA FLESSIONE MODULUS OF RUPTURE BIEGEFESTIGKEIT RÉSISTANCE À LA FLEXION	ISO 10545-4	≥ 35 N/mm ²	50 N/mm ²	50 N/mm ²
 RESISTENZA ALL'ABRASIONE PROFONDA DEEP ABRASION RESISTANCE TIEFENABRIEFESTIGKEIT RÉSISTANCE À L'ABRASION PROFONDE	ISO 10545-6	≤ 175 mm ³	CONFORME COMPLIANT KONFORM CONFORME	CONFORME COMPLIANT KONFORM CONFORME
 DILATAZIONE TERMICA LINEARE LINEAR THERMAL EXPANSION LINEARE WÄRMEAUDEHNUNG DILATATION THERMIQUE LINEAIRE	ISO 10545-8	Requisito non previsto No provision Nicht erforderlich Non prévu	$\alpha \leq 7 \times 10^{-6} \text{ }^{\circ}\text{C}^{-1}$	$\alpha \leq 7 \times 10^{-6} \text{ }^{\circ}\text{C}^{-1}$
 RESISTENZA ALLE MACCHIE STAIN RESISTANCE FLECKENBESTÄNDIGKEIT RÉSISTANCE AUX TACHES	ISO 10545-14	Classe/Class 3 min.	5 RESISTENTE RESISTANT BESTÄNDIG RÉSISTANT ≥ 3 (Lux)	5 RESISTENTE RESISTANT BESTÄNDIG RÉSISTANT ≥ 3 (Lux)
 RESISTENZA ALL'ATTACCO CHIMICO (2) CHEMICAL RESISTANCE (2) CHEMIKALIENBESTÄNDIGKEIT (2) RÉSISTANCE À L'ATTAQUE CHIMIQUE (2)	ISO 10545-13	Come indicato dal produttore As indicated by manufacturer Wie vom Hersteller angegeben Comme indiqué par le producteur	LA - HA RESISTENTE RESISTANT BESTÄNDIG RÉSISTANT LB - HB (Lux)	LA - HA RESISTENTE RESISTANT BESTÄNDIG RÉSISTANT LB - HB (Lux)
 RESISTENZA AL GELO FROST RESISTANCE FROSTBESTÄNDIGKEIT RÉSISTANCE AU GEL	ISO 10545-12	Nessuna alterazione No alterations Keine Änderung Aucune altération	RESISTENTE RESISTANT BESTÄNDIG RÉSISTANT	RESISTENTE RESISTANT BESTÄNDIG RÉSISTANT
 REAZIONE AL FUOCO FIRE REACTION BRANDVERHALTEN REACTION AU FEU	EN 13823 EN 9239-1	CPR (UE) 305/2011 2000/147/CE UNI EN 13501-1	CLASSE/CLASS A2 - s1, d0 (wall) CLASSE/CLASS A2 _{s1} - s1 (floor)	CLASSE/CLASS A1 (wall) CLASSE/CLASS A1 _{s1} (floor)
 CONDUCIBILITÀ TERMICA THERMAL CONDUCTIVITY WÄRMELEITFÄHIGKEIT CONDUCTIVITÉ THERMIQUE	EN 12524	-	$\lambda = 1,3 \text{ W/m}^{\circ}\text{K}$ $\lambda = 0,7 \text{ BTU/ft h}^{\circ}\text{F}$	$\lambda = 1,3 \text{ W/m}^{\circ}\text{K}$ $\lambda = 0,7 \text{ BTU/ft h}^{\circ}\text{F}$
 CARATTERISTICHE DIMENSIONALI DIMENSIONS MASSANGABEN CARACTÉRISTIQUES DIMENSIONNELLES	ISO 10545-2	LUNGHEZZA E LARGHEZZA LENGTH AND WIDTH LÄNGE UND BREITE LONGUEUR ET LARGEUR	± 0,3% max ± 1 mm	CONFORME COMPLIANT KONFORM CONFORME
 RETILINEITÀ SPIGOLI STRAIGHTNESS OF SIDES GERADLINIGKEIT DER KANTEN RECTITUDE DES ARÊTES		± 0,3% max ± 0,8 mm	CONFORME COMPLIANT KONFORM CONFORME	CONFORME COMPLIANT KONFORM CONFORME
 ORTOGONALITÀ RECTANGULARITY RECHTWINKLIGKEIT ORTHOGONALITÉ		± 0,3% max ± 1,5 mm	CONFORME COMPLIANT KONFORM CONFORME	CONFORME COMPLIANT KONFORM CONFORME
 PLANARITÀ FLATNESS EBENFLÄCHIGKEIT PLANÉITÉ		± 0,4% max ± 1,8 mm	CONFORME COMPLIANT KONFORM CONFORME	CONFORME COMPLIANT KONFORM CONFORME
 SPESSORE THICKNESS STÄRKE ÉPAISSEUR		± 5% max ± 0,5 mm	CONFORME COMPLIANT KONFORM CONFORME	CONFORME COMPLIANT KONFORM CONFORME

(1) Valore riferito al solo materiale ceramico_Value referred to ceramic material only_Der Wert bezieht sich ausschließlich auf keramisches Material_Valeur qui se réfère uniquement au matériel céramique
(2) Ad esclusione dell'acido fluoridrico e suoi derivati_Excluding hydrofluoric acid and its derivatives_Ausgenommen den Fluorwasserstoff und seine Derivate_Sauf l'acide fluorhydrique et ses dérivés
(*) Plus: lastra + fibra di vetro_Plus: slab and fibreglass_Plus: Fliese + Glass- Gewebe_Plus: dalle + fibre de verre

Zero.3 LAMINATED PORCELAIN STONWARE

According to: ANSI A137.3 (back-layered gauged porcelain slabs 3plus-5plus / gauged porcelain slabs 6mm - UGL)

TECHNICAL FEATURES	TEST METHOD	REQUIRED VALUES ANSI A137.3	AVERAGE VALUES Zero.3 3plus*	AVERAGE VALUES Zero.3 5plus*	AVERAGE VALUES Zero.3 6mm
 WATER ABSORPTION	ASTM C373	≤ 0.5%	0.1% (1)	0.1% (1)	0.1%
 MODULUS OF RUPTURE	ASTM C1505	≥ 6000 PSI	≥ 6000 PSI	≥ 6000 PSI	≥ 6000 PSI
 BREAKING STRENGTH	ASTM C1505	Thickness 3.5-4.9 mm: ≥ 85 lbf Thickness 5-6.5 mm: ≥ 175 lbf	≥ 85 lbf	≥ 175 lbf	≥ 175 lbf
 DEEP ABRASION RESISTANCE	ASTM C1243	≤ 175 mm ³	COMPLIANT	COMPLIANT	COMPLIANT
 LINEAR THERMAL EXPANSION	ASTM C372	As indicated by manufacturer	$\alpha \leq 4.4 \times 10^{-6} \text{ }^{\circ}\text{F}^{-1}$ $\alpha \leq 8 \times 10^{-6} \text{ }^{\circ}\text{C}^{-1}$	$\alpha \leq 4.4 \times 10^{-6} \text{ }^{\circ}\text{F}^{-1}$ $\alpha \leq 8 \times 10^{-6} \text{ }^{\circ}\text{C}^{-1}$	$\alpha \leq 4.4 \times 10^{-6} \text{ }^{\circ}\text{F}^{-1}$ $\alpha \leq 8 \times 10^{-6} \text{ }^{\circ}\text{C}^{-1}$
 STAIN RESISTANCE	ASTM C1378	As indicated by manufacturer	A RESISTANT	A RESISTANT C (Lux)	A RESISTANT C (Lux)
 CHEMICAL RESISTANCE (2)	ASTM C650	As indicated by manufacturer	A RESISTANT	A RESISTANT C (Lux)	A RESISTANT C (Lux)
 FROST RESISTANCE	ASTM C1026	As indicated by manufacturer	RESISTANT	RESISTANT	RESISTANT
 FLAME SPREAD	ASTM E84	-	CLASS A	CLASS A	CLASS A
 DIMENSIONS	ASTM C499	NOMINAL DIMENSIONS Max ±3.0% of nominal dimensions	COMPLIANT	COMPLIANT	COMPLIANT
 CALIBER RANGE	ASTM C499	Max ±0.25% or max ±0.03*	COMPLIANT	COMPLIANT	COMPLIANT
 THICKNESS	ASTM C499	Max ±0.5 mm (±0.02") from nominal thickness	COMPLIANT	COMPLIANT	COMPLIANT
 THICKNESS VARIATION	ASTM C499	0.5 mm (0.02")	COMPLIANT	COMPLIANT	COMPLIANT
 WEDGING	ASTM C502	Max ±0.25% or max ±0.03*	COMPLIANT	COMPLIANT	COMPLIANT

(1) Value referred to ceramic material only
(2) Excluding hydrofluoric acid and its derivatives
(*) Plus: slab and fibreglass

Caratteristiche tecniche

Technical features_Technische Eigenschaften_Caractéristiques techniques

GRES PORCELLANATO_PORCELAIN STONEWARE_FEINSTEINZEUG_GRÈS CÉRAMÉ

Conforme_according to_Gemäß_conforme: **ISO 13006-G - EN 14411-G Gruppo/Group Bla**

CARATTERISTICHE TECNICHE TECHNICAL FEATURES TECHNISCHE EIGENSCHAFTEN CARACTÉRISTIQUES TECHNIQUES	METODO DI PROVA TEST METHOD PRÜFMETHODE MÉTHODE D'ESSAI	REQUISITI PRESCRITTI REQUIRED VALUES VORGELEGENE ANFORDERUNGEN VALEURS REQUISES ISO 13006-G - EN 14411-G Gruppo/Group Bla	VALORI MEDI AVERAGE VALUES DURCHSCHNITTLICHE WERTE VALEURS MOYENNES Non smaltato - UGL Unglazed - UGL
ASSORBIMENTO D'ACQUA WATER ABSORPTION WASSERAUFNAHMEFÄHIGKEIT ABSORPTION D'EAU	ISO 10545-3	≤ 0,5%	0,05%
SFORZO DI ROTTURA (S) BREAKING STRENGTH (S) BRUCHWIDERSTAND (S) CHARGE DE RUPTURE (S)	ISO 10545-4	≥ 1300 N	CONFORME COMPLIANT KONFORM CONFORME 13.600 N (20 mm)
RESISTENZA ALLA FLESSIONE MODULUS OF RUPTURE BIEGEFESTIGKEIT RÉSISTANCE À LA FLEXION	ISO 10545-4	≥ 35 N/mm ²	50 N/mm²
CLASSE REQUISITI MECCANICI MECHANICAL REQUIREMENTS CLASS KLASSE DER MECHANISCHEN ANFORDERUNGEN CLASSE EXIGENCES MÉCANIQUE	EN 1339	Requisito non previsto No provision Nicht erforderlich Non prévu	U14 (20 mm) (2)
RESISTENZA ALL'ABRASIONE PROFONDA DEEP ABRASION RESISTANCE TIEFENABRIEFESTIGKEIT RÉSISTANCE À L'ABRASION PROFONDE	ISO 10545-6	≤ 175 mm ³	145 mm³ 150 mm³ (Lux)
DILATAZIONE TERMICA LINEARE LINEAR THERMAL EXPANSION LINEARE WÄRMELÄNGENÄNDERUNG DILATATION THERMIQUE LINÉAIRE	ISO 10545-8	Requisito non previsto No provision Nicht erforderlich Non prévu	α ≤ 7 x 10⁻⁶ °C⁻¹
RESISTENZA AL CAVILLO CRAZING RESISTANCE HAARISBESTÄNDIGKEIT RÉSISTANCE AU TRESSILLAGE	ISO 10545-11	Nessuna alterazione No alterations Keine Änderung Aucune altération	NON APPLICABILE NOT APPLICABLE NICHT ANWENDBAR NON APPLICABLE
RESISTENZA ALLE MACCHIE STAIN RESISTANCE FLECKENBESTÄNDIGKEIT RÉSISTANCE AUX TACHES	ISO 10545-14	Classe/Class 3 min.	5 RESISTENTE RESISTANT BESTÄNDIG RÉSISTANT ≥ 3 (Lux)
RESISTENZA ALL'ATTACCO CHIMICO (1) CHEMICAL RESISTANCE (1) CHEMIKALIENBESTÄNDIGKEIT (1) RÉSISTANCE À L'ATTAQUE CHIMIQUE (1)	ISO 10545-13	Come indicato dal produttore As indicated by manufacturer Wie vom Hersteller angegeben Comme indiqué par le producteur	LA - HA RESISTENTE RESISTANT BESTÄNDIG RÉSISTANT
CESSIONE DI PIOMBO E CADMIO LEAD AND CADMIUM GIVEN OFF ABGABE VON KADMIIUM UND BLEI DÉGAGEMENT DE CADMIUM ET PLOMB	ISO 10545-15	Requisito non previsto No provision Nicht erforderlich Non prévu	NON APPLICABILE NOT APPLICABLE NICHT ANWENDBAR NON APPLICABLE
RESISTENZA AL GELO FROST RESISTANCE FROSTBESTÄNDIGKEIT RÉSISTANCE AU GEL	ISO 10545-12	Nessuna alterazione No alterations Keine Änderung Aucune altération	RESISTENTE RESISTANT BESTÄNDIG RÉSISTANT
REAZIONE AL FUOCO FIRE REACTION BRANDVERHALTEN RÉACTION AU FEU	EN 13823 EN 9239-1	CPR (UE) 305/2011 2000/147/CE UNI EN 13501-1	CLASSE/CLASS A1 (wall) CLASSE/CLASS A1_s (floor)
CONDUCIBILITÀ TERMICA THERMAL CONDUCTIVITY WÄRMELEITFÄHIGKEIT CONDUCTIVITÉ THERMIQUE	EN 12524	-	λ = 1,3 W/m²K λ = 0.7 Btu/ft h²F
CARATTERISTICHE DIMENSIONALI DIMENSIONS MASSANGABEN CARACTÉRISTIQUES DIMENSIONNELLES	ISO 10545-2	LUNGHEZZA E LARGHEZZA LENGTH AND WIDTH LÄNGE UND BREITE LONGUEUR ET LARGEUR Rettificato / Rectified / Rektifiziert / Rectifié ± 0,3% max ± 1 mm	CONFORME COMPLIANT KONFORM CONFORME
RETTILINEITÀ SPIGOLI STRAIGHTNESS OF SIDES GERADLINIGKEIT DER KANTEN RECTITUDE DES ARÊTES		Non rettificato / Not rectified / Nicht Rektifiziert / Non Rectifié ± 0,5% max ± 1,5 mm Rettificato / Rectified / Rektifiziert / Rectifié ± 0,3% max ± 0,8 mm	CONFORME COMPLIANT KONFORM CONFORME
ORTOGONALITÀ RECTANGULARITY RECHTWINKLIGKEIT ORTHOGONALITÉ		Non rettificato / Not rectified / Nicht Rektifiziert / Non Rectifié ± 0,5% max ± 2 mm Rettificato / Rectified / Rektifiziert / Rectifié ± 0,3% max ± 1,5 mm	CONFORME COMPLIANT KONFORM CONFORME
PLANARITÀ FLATNESS EBENFLÄCHIGKEIT PLANÉITÉ		Non rettificato / Not rectified / Nicht Rektifiziert / Non Rectifié ± 0,5% max ± 2 mm Rettificato / Rectified / Rektifiziert / Rectifié ± 0,4% max ± 1,8 mm	CONFORME COMPLIANT KONFORM CONFORME
SPESSORE THICKNESS STÄRKE ÉPAISSEUR		± 5% max ± 0,5 mm	CONFORME COMPLIANT KONFORM CONFORME

(1) Ad esclusione dell'acido fluoridrico e suoi derivati. Excluding hydrofluoric acid and its derivatives. Ausgenommen den Fluorwasserstoff und seine Derivate. Sauf l'acide fluorhydrique et ses dérivés

(2) Carrabile quando incollata su massetto. La classificazione si riferisce al solo formato quadrato, fino a 60x60 cm. Can be driven on when glued on screed. The classification only refers to the square format, up to 60x60 cm. Befahrbar bei Verkleben auf Estrich. Die Klassifikation bezieht sich nur auf das quadratische Format, bis zu 60x60 cm. Carrossable s'il est collé sur une chape. La classification ne concerne que le format carré, jusqu'à 60x60 cm

PORCELAIN STONEWARE

According to: **ANSI A137.1 (glazed and unglazed porcelain tiles - P1 Class)**

TECHNICAL FEATURES	TEST METHOD	REQUIRED VALUES ANSI A137.1 Porcelain Tiles P1 Class	AVERAGE VALUES Unglazed - UGL	AVERAGE VALUES Glazed - GL
WATER ABSORPTION	ASTM C373	≤ 0.5%	0.05%	0.05%
BREAKING STRENGTH	ASTM C648	≥ 250 lbf	COMPLIANT 2,800 LBF (20 mm)	COMPLIANT
DEEP ABRASION RESISTANCE	ASTM C1243	≤ 175 mm ³	145 mm³ 150 mm³ (Lux)	NOT APPLICABLE
LINEAR THERMAL EXPANSION	ASTM C372	No provision	α ≤ 4.4 x 10⁻⁶ °F⁻¹ α ≤ 8 x 10⁻⁶ °C⁻¹	α ≤ 4.4 x 10⁻⁶ °F⁻¹ α ≤ 8 x 10⁻⁶ °C⁻¹
CRAZING RESISTANCE	ASTM C424	No alterations	NOT APPLICABLE	RESISTANT
STAIN RESISTANCE	ASTM C1378	As indicated by manufacturer	A RESISTANT C (Lux)	A RESISTANT
CHEMICAL RESISTANCE (1)	ASTM C650	As indicated by manufacturer	A RESISTANT	A RESISTANT
LEAD AND CADMIUM GIVEN OFF	ASTM C895	No provision	NOT APPLICABLE	COMPLIANT
FROST RESISTANCE	ASTM C1026	As indicated by manufacturer	RESISTANT	RESISTANT
FLAME SPREAD	ASTM E84	-	CLASS A	CLASS A
DIMENSIONS	ASTM C485	EDGE WARPAGE Rectified ± 0.40% or ± 0.05 inch* or ± 1.8 mm** *Whichever is less, for tiles up to 24" (610 mm) on any side **Applies to tiles larger than 24" (610 mm) on any side Calibrated ± 0.50% or max ± 0.07"	COMPLIANT	COMPLIANT
	ASTM C485	DIAGONAL WARPAGE Rectified ± 0.40% or max ± 0.07* Calibrated ± 0.50% or max ± 0.07"	COMPLIANT	COMPLIANT
	ASTM C499	NOMINAL DIMENSIONS Rectified -3.0% / +2.0% of nominal dimensions Calibrated ± 3.0% of nominal dimensions	± 1.5%	± 1.5%
	ASTM C499	CALIBER RANGE Rectified ± 0.25% or max ± 0.03* Calibrated ± 0.50% or max ± 0.08"	COMPLIANT	COMPLIANT
	ASTM C499	THICKNESS ≤ 0.040* Calibrated ± 0.040"	≤ 0.030 inch	≤ 0.030 inch
	ASTM C502	WEDGING Rectified ± 0.25% or max ± 0.03* Calibrated ± 0.50% or max ± 0.08"	COMPLIANT	COMPLIANT

















(1) Excluding hydrofluoric acid and its derivatives

Caratteristiche tecniche

Technical features_Technische Eigenschaften_Caractéristiques techniques

RIVESTIMENTO MONOPOROSA IN PASTA BIANCA SMALTATA_GLAZED WHITE BODY POROUS SINGLE-FIRED WALL TILES_ GLASIERTE WEISSSCHÄRBIGE WANDFLIESE_FAÏENCES PÂTE BLANCHE ÉMAILLÉ











Conforme_according to_Gemäß_conforme: **ISO 13006-L - EN 14411-L Gruppo/Group BIII - GL**

CARATTERISTICHE TECNICHE TECHNICAL FEATURES TECHNISCHE EIGENSCHAFTEN CARACTÉRISTIQUES TECHNIQUES	METODO DI PROVA TEST METHOD PRÜFMETHODE MÉTHODE D'ESSAI	REQUISITI PRESCRITTI REQUIRED VALUES VORGEBENE ANFORDERUNGEN VALEURS REQUISES ISO 13006-L - EN 14411-L Gruppo/ Group BIII GL	VALORI MEDI AVERAGE VALUES DURCHSCHNITTLICHE WERTE VALEURS MOYENNES Smaltato / Glazed BIII GL
 ASSORBIMENTO D'ACQUA WATER ABSORPTION WASSERAUFNAHMEFÄHIGKEIT ABSORPTION D'EAU	ISO 10545-3	> 10%	> 10%
 RESISTENZA ALLA FLESSIONE MODULUS OF RUPTURE BIEGEFESTIGKEIT RÉSISTANCE À LA FLEXION	ISO 10545-4	≥ 12 N/mm ²	18 N/mm²
 SFORZO DI ROTTURA (S) BREAKING STRENGTH (S) BRUCHWIDERSTAND (S) CHARGE DE RUPTURE (S)	ISO 10545-4	≥ 600 N	≥ 600 N
 DILATAZIONE TERMICA LINEARE LINEAR THERMAL EXPANSION LINEARE WÄRMEAUSSDEHNUNG DILATATION THERMIQUE LINÉAIRE	ISO 10545-8	Requisito non previsto No provision Nicht erforderlich Non prévu	$\alpha \leq 7 \times 10^{-6} \text{ }^{\circ}\text{C}^{-1}$
 RESISTENZA AL CAVILLO CRAZING RESISTANCE HAARISBESTÄNDIGKEIT RÉSISTANCE AU TRESSILLAGE	ISO 10545-11	Nessuna alterazione No alterations Keine Änderung Aucune altération	RESISTENTE RESISTANT BESTÄNDIG RÉSISTANT
 RESISTENZA ALLE MACCHIE STAIN RESISTANCE FLECKENBESTÄNDIGKEIT RÉSISTANCE AUX TACHES	ISO 10545-14	Classe/Class 3 min.	5 RESISTENTE RESISTANT BESTÄNDIG RÉSISTANT
 RESISTENZA ALL'ATTACCO CHIMICO (1) CHEMICAL RESISTANCE (1) CHEMIKALIENBESTÄNDIGKEIT (1) RÉSISTANCE À L'ATTAQUE CHIMIQUE (1)	ISO 10545-13	Come indicato dal produttore As indicated by manufacturer Wie vom Hersteller angegeben Comme indiqué par le producteur	LA - HA RESISTENTE RESISTANT BESTÄNDIG RÉSISTANT
 CESSIONE DI PIOMBO E CADMIO LEAD AND CADMIUM GIVEN OFF ABGABE VON KADMIIUM UND BLEI DÉGAGEMENT DE CADMIUM ET PLOMB	ISO 10545-15	Requisito non previsto No provision Nicht erforderlich Non prévu	CONFORME COMPLIANT KONFORM CONFORME
 RESISTENZA AL GELO FROST RESISTANCE FROSTBESTÄNDIGKEIT RÉSISTANCE AU GEL	ISO 10545-12	Come indicato dal produttore As indicated by manufacturer Wie vom Hersteller angegeben Comme indiqué par le producteur	NON RESISTENTE NOT RESISTANT NICHT BESTÄNDIG PAS RÉSISTANT
 REAZIONE AL FUOCO FIRE REACTION BRANDVERHALTEN RÉACTION AU FEU	EN 13823	CPR (UE) 305/2011 2000/147/CE UNI EN 13501-1	CLASSE/CLASS A1 (wall)
 CONDUCIBILITÀ TERMICA THERMAL CONDUCTIVITY WÄRMELEITFÄHIGKEIT CONDUCTIVITÉ THERMIQUE	EN 12524	-	$\lambda = 0,7 \text{ W/m}^{\circ}\text{K}$ $\lambda = 0,4 \text{ Btu/ft h}^{\circ}\text{F}$
 CARATTERISTICHE DIMENSIONALI DIMENSIONS MASSANGABEN CARACTÉRISTIQUES DIMENSIONNELLES	ISO 10545-2	LUNGHEZZA E LARGHEZZA LENGTH AND WIDTH LÄNGE UND BREITE LONGUEUR ET LARGEUR Rettificato / Rectified / Rektifiziert / Rectifié ± 0,3% max ± 1 mm	CONFORME COMPLIANT KONFORM CONFORME
 RETTILINEITÀ SPIGOLI STRAIGHTNESS OF SIDES GERADLINIGKEIT DER KANTEN RECTITUDE DES ARÊTES		Rettificato / Rectified / Rektifiziert / Rectifié ± 0,3% max ± 0,8 mm	CONFORME COMPLIANT KONFORM CONFORME
 ORTOGONALITÀ RECTANGULARITY RECHTWINKLIGKEIT ORTHOGONALITÉ		Rettificato / Rectified / Rektifiziert / Rectifié ± 0,3% max ± 1,5 mm	CONFORME COMPLIANT KONFORM CONFORME
 PLANARITÀ FLATNESS EBENFLÄCHIGKEIT PLANÉITÉ		Rettificato / Rectified / Rektifiziert / Rectifié ± 0,4% max ± 1,8 mm	CONFORME COMPLIANT KONFORM CONFORME
 SPESORE THICKNESS STÄRKE ÉPAISSEUR		± 10% max ± 0,5 mm	CONFORME COMPLIANT KONFORM CONFORME

(1) Ad esclusione dell'acido fluoridrico e suoi derivati_Excluding hydrofluoric acid and its derivatives_Ausgenommen den Fluorwasserstoff und seine Derivate_Sauf l'acide fluorhydrique et ses dérivés

GLAZED WHITE BODY POROUS SINGLE-FIRED WALL TILES

According to: ANSI A137.1 (glazed wall tiles - P4 Class)

TECHNICAL FEATURES	TEST METHOD	REQUIRED VALUES ANSI A137.1 wall tiles P4 Class	AVERAGE VALUES Glazed - GL
 WATER ABSORPTION	ASTM C373	7% < E _v ≤ 20%	7% < E_v ≤ 20%
 BREAKING STRENGTH	ASTM C648	≥ 125 lbf	≥ 125 lbf
 LINEAR THERMAL EXPANSION	ASTM C372	No provision	$\alpha \leq 4,4 \times 10^{-6} \text{ }^{\circ}\text{F}^{-1}$ $\alpha \leq 8 \times 10^{-6} \text{ }^{\circ}\text{C}^{-1}$
 CRAZING RESISTANCE	ASTM C424	No alterations	RESISTANT
 STAIN RESISTANCE	ASTM C1378	As indicated by manufacturer	A RESISTANT
 CHEMICAL RESISTANCE (1)	ASTM C650	As indicated by manufacturer	A RESISTANT
 LEAD AND CADMIUM GIVEN OFF	ASTM C895	No provision	COMPLIANT
 FROST RESISTANCE	ASTM C1026	As indicated by manufacturer	NOT RESISTANT
 FLAME SPREAD	ASTM E84	No provision	CLASS A
 DIMENSIONS	ASTM C485	EDGE WARPAGE Rectified - 0.30% / + 0.40% or max - 0.04" / +0.05"	COMPLIANT
	ASTM C485	DIAGONAL WARPAGE Rectified - 0.30% / + 0.40% or max - 0.05" / +0.07"	COMPLIANT
	ASTM C499	NOMINAL DIMENSIONS Rectified ±2.0% of nominal dimensions	± 1.0%
	ASTM C499	CALIBER RANGE Rectified ± 0.25% or max ± 0.03"	COMPLIANT
	ASTM C499	THICKNESS ≤ 0.031"	COMPLIANT
	ASTM C502	WEDGING Rectified ± 0.25% or max ± 0.03"	COMPLIANT

(1) Excluding hydrofluoric acid and its derivatives

Caratteristiche tecniche

Technical features_Technische Eigenschaften_Caractéristiques techniques

PRODOTTO DECORATO CON TECNOLOGIA A FREDDO_PRODUCTS DECORATED WITH COLD DECORATING TECHNOLOGY_KALTTECHNOLOGIE DEKORIERTEN PRODUKTS_PRODUIKT DÉCORÉ AVEC TECHNOLOGIE À FROID

Collezione Glam_Glam collection_Kollektion Glam_Collection Glam / **Decorì Flora collezione Experience**_Flora decors Experience collection_Flora-Dekore Experience Kollektion_décors Flora collection Experience / **Decorì Hive - Inlay - Katana collezione Blade**_Hive - Inlay - Katana decors Blade collection_Hive - Inlay - Katana-Dekore Blade Kollektion_décors Hive - Inlay - Katana collection Blade

Le lastre sono decorate mediante la tecnologia di stampa digitale a freddo, che permette di raggiungere risultati estetici e cromatici di eccezionale qualità. Le grafiche vengono impresse ad altissima risoluzione sul supporto ceramico, mantenendo invariati i colori brillanti e le sfumature dei motivi decorativi.

The slabs are decorated using digital cold printing technology, with which aesthetic, chromatic results of exceptional quality are achieved. The graphics are printed at very high resolution on the ceramic substrate, keeping the brilliant colors and shades of the decorative designs unaltered.

Die Platten werden nach dem Brennen im digitalen Kaltdruckverfahren dekoriert, mit dem sich optische und farbliche Ergebnisse von höchster Qualität erzielen lassen. Die Motive werden mit extrem hoher Auflösung auf die Keramikfliese gedruckt, wobei die Leuchtkraft der Farben und die Nuancen der Motive perfekt erhalten bleiben.

Les dalles sont décorées grâce à la technologie d'impression numérique à froid, qui permet d'obtenir des résultats esthétiques et chromatiques d'une qualité exceptionnelle. Les graphismes sont imprimés en haute résolution sur le support céramique, en préservant la brillance des couleurs et les nuances des motifs décoratifs.

CARATTERISTICHE PRODOTTO_PRODUCT CHARACTERISTICS_PRODUKTMERKMALE_CARACTÉRISTIQUES DU PRODUIT

Rivestimenti decorati da interno_Interior decorated wall coverings_Dekorierte Wandbelege für Innenbereich_Décors pour revêtement mural intérieur

DESTINAZIONI D'USO INTENDED USES EINSATZBEREICHE UTILISATIONS PRÉVUES	Idonei esclusivamente per la posa a parete in ambienti interni; non posare a pavimento e a rivestimento in luoghi esterni.	Intended exclusively for the cladding of interior walls; do not use as flooring or to clad exterior spaces.	Ausschließlich für die Wandverlegung in Innenbereichen geeignet; nicht für das Verlegen von Fußböden und Wandverkleidung im Außenbereich geeignet.	Approprié exclusivement pour la pose au mur dans les environnements intérieurs; ne pas poser au sol et en revêtement dans les environnements extérieurs.
RESISTENZA ALLE MACCHIE STAIN RESISTANCE FLECKENBESTÄNDIGKEIT RÉSISTANCE AUX TACHES ISO 10545-14	Conforme alla Classe 5. Resiste alle macchie di alimenti e bevande. Non resiste alla tintura di iodio, blu di metilene, pennarello indelebile.	Class-5, resistance to food and beverage stains. Not resistant to iodine dye, methylene blue, or permanent marker.	Fleckenbeständig gegen Lebensmittel- und Getränkeflecken, konform mit Klasse 5, nicht beständig gegen Jodfarben, Methylenblau, Permanentmarker.	Résiste aux taches d'aliments et boissons conforme à la classe 5. Ne résiste pas à la teinture d'iode, bleu de méthylène, feutre indélébile.
RESISTENZA ATTACCO CHIMICO CHEMICAL RESISTANCE CHEMIKALIENBESTÄNDIGKEIT RÉSISTANCE À L'ATTAQUE CHIMIQUE ISO 10545-13	LB-HB	LB-HB	LB-HB	LB-HB
RESISTENZA SUPERFICIALE SURFACE STRENGTH OBERFLÄCHENBESTÄNDIGKEIT RÉSISTANCE SUPERFICIELLE	La decorazione di questi prodotti non ha una buona resistenza ai graffi di oggetti acuminati molto duri come ad esempio metallo, pietra, vetro e gres. Prestare la massima attenzione alla movimentazione durante le operazioni di posa evitando di urtare o strisciare utensili ed oggetti duri acuminati sulla superficie.	This product's decoration is not scratch resistant to hard, sharp objects such as metal, stone, glass and stoneware. Be extremely careful when handling the product during installation, making sure not to knock or slide tools or other sharp objects against the surface.	Die Dekoration dieser Produkte ist nicht sehr beständig gegen Kratzer durch sehr harte spitze Gegenstände, zum Beispiel aus Metall, Stein, Glas und Feinsteinzeug. Gehen Sie bei der Handhabung der Platten während der Verlegung besonders vorsichtig vor und vermeiden Sie Stöße oder Kratzer auf der Oberfläche durch Werkzeuge oder andere harte Gegenstände.	La décoration de ces produits ne résiste pas bien aux rayures causées par les objets pointus et très durs tels que le métal, la pierre, le verre ou le grès, entre autres. Faire particulièrement attention à la manipulation au cours des opérations de pose, en évitant de heurter ou de faire glisser les outils et les objets durs et pointus sur la surface.





AVVERTENZE PER LA POSA E LA PULIZIA_WARNINGS FOR LAYING AND CLEANING_HINWEISE ZUR VERLEGUNG UND REINIGUNG_MISES EN GARDE POUR LA POSE ET LE NETTOYAGE

Collezione Glam_Glam collection_Kollektion Glam_Collection Glam / **Decorì Flora collezione Experience**_Flora decors Experience collection_Flora-Dekore Experience Kollektion_décors Flora collection Experience / **Decorì Hive - Inlay - Katana collezione Blade**_Hive - Inlay - Katana decors Blade collection_Hive - Inlay - Katana-Dekore Blade Kollektion_décors Hive - Inlay - Katana collection Blade

POSA INSTALLATION VERLEGUNG POSE	Spalmare la colla con spatola dentata di almeno 5 mm sul fondo della parete ed applicare la lastra a muro. Trattandosi di rivestire una parete di ambiente interno non è necessaria la spalmatura nel retro della lastra. Per un miglior risultato estetico si consiglia la posa distanziando le lastre con solo 1 mm di fuga. Non usare sistemi meccanici livellanti poiché la loro rimozione potrebbe danneggiare la superficie. Battere bene la lastra con spatola gommata al fine di allineare le lastre fra di loro.	Spread the adhesive using a notched trowel (of at least 5 mm) on the base of the wall and apply the slab. As this product is to be used for cladding in interior spaces, it is not necessary to apply adhesive to the back of the slab (back-butter). For optimum aesthetic results it is best to leave only 1 mm of space between the slabs. Do not use mechanical levelling systems as their removal could damage the surface. Use a rubber trowel to tap the slabs so that they are perfectly in line with one another.	Den Kleber mit dem Zahnpachtel von mindestens 5 mm auf dem Wanduntergrund auftragen und die Platte an der Wand ankleben. Da es sich hierbei um eine Innenwand handelt braucht keine Klebschicht auch auf der Rückseite der Platte aufgetragen werden. Für ein besseres ästhetisches Ergebnis wird empfohlen die Platten mit einem Fugenabstand von 1 mm zu verlegen. Keine nivellierenden mechanischen Hilfsmittel verwenden, da das Entfernen derselben die Oberflächen beschädigen könnten. Die Platte mit einem Gummispachtel fest anklopfen und die Platten untereinander ausrichten.	Étaler le mortier-colle sur le mur à l'aide d'une spatule crantée d'au moins 5 mm, puis appliquer la dalle au mur. Comme il s'agit d'habiller un mur d'espace intérieur, il n'est pas nécessaire d'étaler le mortier-colle au dos de la dalle. Pour un meilleur résultat esthétique, il est conseillé d'effectuer la pose en séparant les dalles avec un joint de 1 mm seulement. Ne pas utiliser de systèmes mécaniques de nivellement car leur retrait peut endommager la surface. Bien tapoter les dalles à l'aide d'une spatule en caoutchouc afin de les aligner parfaitement les unes avec les autres.
STUCCATURA GROUTING VERFUGUNG JOINTOIEMENT	Sigillare le fughe solo con stucchi cementizi, non usare stucchi epossidici.	Seal the joints using only cementitious grouting products, do not use epoxy grouting products.	Die Fugen nur mit Zementmörtel verfugen; keine Epoxid-Mörtel verwenden.	Sceller les joints uniquement avec des mortiers de ciment, ne pas utiliser de mortiers époxydiques.
PULIZIA QUOTIDIANA DAILY CLEANING TÄGLICHE REINIGUNG NETTOYAGE JOURNALIER	Utilizzare acqua o detersivi neutri comunemente in vendita presso i negozi. Per lo sporco ostinato utilizzare un qualunque detersivo sgrassante purché non sia di alto valore alcalino. Non utilizzare mai alcool, acetone, solventi, candeggina, ammoniaca e prodotti alcalini o acidi di forte intensità. Non usare paste, spugne e spazzole abrasive.	Use water or neutral detergents normally available in stores. For more stubborn spots use any low-alkaline degreaser. Do not use alcohol, acetone, solvents, bleach, ammonia, and highly alkaline or highly acidic products. Do not use abrasive pastes, sponges, or brushes.	Wasser oder neutrale im Handel erhältliche Reinigungsmittel verwenden. Bei stärkeren Verschmutzungen ein beliebiges fettlösendes Reinigungsmittel verwenden, sofern es keinen hohen alkalischen Wert hat. Niemals Alkohol, Aceton, Lösungsmittel, Bleichmittel, Ammoniak und alkalische Produkte oder starke Säuremittel verwenden. Keine Pasten, scheuernde Schwämme oder Bürsten einsetzen.	Utiliser de l'eau ou des détergents neutres généralement en vente dans les magasins. Pour la saleté tenace, utiliser un détergent dégraissant quelconque dont la valeur alcaline n'est pas élevée. Ne jamais utiliser d'alcool, d'acétone, de solvants, d'eau de javel, d'ammoniaque, de produits alcalins ou d'acides à forte intensité. Ne pas utiliser de pâtes, d'éponges ou de brosses abrasives.
TAGLIO E FORATURA CUTTING AND DRILLING SCHNITT- UND BOHRARBEITEN DÉCOUPE ET PERÇAGE	Per il taglio e la foratura è essenziale lavorare su una superficie planare e pulita. Eseguire il taglio solo con disco diamantato sottile sp. 1,2 mm (es: Tyrolit Premium DCT 1A1R) montato sulla guida della macchina da taglio (es: Kera-cut di Sigma) oppure a mano con smerigliatrice-flessibile. Eseguire i fori con trapano senza percussione con punta al tungsteno bagnandola ripetutamente con acqua. Per fori grandi utilizzare frese a tazza diamantate a fascia continua montate su smerigliatrice (flessibile).	For cutting and drilling it is essential to work on a flat, clean surface. To cut the material, use a 1.2 mm-thick diamond disk (ex. Tyrolit Premium DCT 1A1R) mounted on a cutting tool guide (ex. Kera-cut by Sigma) or by hand with a flexible-grinder. For drilling use a non-hammer drill with a tungsten drill bit and wet it repeatedly with water. For large holes use a continuous crown diamond hole saw mounted on a grinder.	Für das Schneiden und Bohren der Platte ist das Arbeiten auf einer ebenen und sauberen Oberfläche unerlässlich. Schneiden Sie nur mit einer dünnen, 1,2 mm starken Diamantscheibe (z.B. Tyrolit Premium DCT 1A1R), die auf der Führung der Schneidemaschine (z.B. Kera-cut Sigma) montiert ist, oder mit einer Handschleifmaschine (Flex) ausführen. Die Bohrungen mit einem Normalbohrer (keinem Schlagbohrer) mit Tungsten-Spitze vornehmen und ständig mit Wasser benetzen. Für große Bohrungen Diamant-Topfräser mit Endlosband, die auf eine Schleifmaschinen (Flex) montiert sind, verwenden.	Pour couper et percer, il est essentiel de travailler sur une surface plane et propre. Effectuer la coupe à l'aide d'un disque diamanté fin d'une épaisseur de 1,2 mm (ex: Tyrolit Premium DCT 1A1R) monté sur le guide de la machine de coupe (ex : Kera-cut de Sigma) ou à la main avec une meuleuse d'angle. Percer les trous à l'aide d'une perceuse sans percussion équipée d'un foret au tungstène, en la mouillant plusieurs fois avec de l'eau. Pour les trous plus grands, utiliser des trépan diamantés à bande continue montés sur des meuleuses d'angles.
STOCCAGGIO STORAGE LAGERUNG STOCKAGE	Stoccare i prodotti in un luogo asciutto e al riparo da agenti atmosferici.	Store the products in a dry place, protected from the effects of the weather.	Die Produkte müssen an einem trockenen und vor Witterungseinflüssen geschützten Ort gelagert werden.	Stocker les produits dans un endroit sec à l'abri des agents atmosphériques.

Destinazioni d'uso

Intended use_Einsatzbereiche_Utilisations prévues

LEGENDA LEGEND LEGENDE LÉGENDE	 RESIDENZIALE_RESIDENTIAL_ WOHNBEREICH_RÉSIDENTIEL	 COMMERCIALE LEGGERO LIGHT COMMERCIAL_LEICHTE GEWERBLICHE ANWENDUNGEN_ COMMERCIAL LÉGER	 COMMERCIALE INTENSIVO INTENSIVE COMMERCIAL_INTENSIVE GEWERBLICHE ANWENDUNGEN_ COMMERCIAL INTENSIF	 ESTERNI_OUTDOOR_ AUSSENBEREICHE_EXTÉRIEURS
EFFETTO PIETRA_STONE LOOK_ STEIN-OPTIK_EFFET PIERRE				
BIOARCH	-	-	-	STRUTTURATO
DISCOVER	NATURALE	NATURALE	NATURALE	STRUTTURATO
FRAME	NATURALE	NATURALE	NATURALE	STRUTTURATO
PIERRE DES RÊVES	NATURALE	NATURALE	NATURALE	STRUTTURATO - EXT
PIETRE DI FANES	-	-	-	STRUTTURATO
PRIME STONE	SOFT	SOFT	SOFT	STRUTTURATO
PRIME STONE Zero.3	NATURALE	NATURALE	NATURALE	-
STONE TRACE Zero.3	NATURALE	NATURALE	NATURALE	-
THE PLACE	NATURALE - SOFT	NATURALE - SOFT	NATURALE	STRUTTURATO - EXT
VIA MAESTRA	NATURALE	NATURALE	NATURALE	STRUTTURATO
EFFETTO CEMENTO_CONCRETE LOOK_ZEMENT-OPTIK_EFFET CIMENT				
CONTEXT	NATURALE	NATURALE	NATURALE	STRUTTURATO
EXPERIENCE Zero.3	NATURALE	NATURALE	-	-
MEMORY MOOD	NATURALE	NATURALE	NATURALE	-
URBANATURE	NATURALE	NATURALE	NATURALE	STRUTTURATO - EXT
URBANATURE Zero.3	NATURALE	NATURALE	-	-

Residenziale: cucine, bagni, living e ogni altro ambiente di uso residenziale.
Commerciale leggero: uffici, uffici aperti al pubblico, sale d'attesa, negozi, bagni pubblici, aree comuni condominiali, sale di ristoranti, autosaloni, bar, cinema, ambulatori/cliniche, camere e bagni di hotel. In aree caratterizzate da passaggi obbligati, o dove è previsto l'utilizzo di sedie con ruote in plastica dura, non è consigliato l'utilizzo di prodotti con finitura LUX.
Commerciale intensivo: aree comuni di centri commerciali, hall di hotel, mense, fast food, discoteche, ospedali, scuole, musei, luoghi di culto, aeroporti, stazioni.
 Esterni: prevalentemente per ambienti esterni nei quali è richiesta una pavimentazione con prestazioni antiscivolo.

NOTE

La finitura LUX è consigliata, oltre che per rivestimenti, anche per pavimenti in ambienti residenziali o commerciale leggero non sottoposti ad elevate sollecitazioni, ove non siano richieste prestazioni antiscivolo.

La presenza sporadica di piccole disuniformità o di puntini sulla superficie è da ritenersi come caratteristica del materiale e della particolare lavorazione. Qualora il prodotto sia posto a diretto contatto con l'esterno, si consiglia di utilizzare soluzioni protettive al fine di prevenire la formazione di graffi. È responsabilità del posatore provvedere sempre alla protezione della piastrellatura finita e pulita, prima della consegna al committente, tramite appositi materiali protettivi (es. pannelli in truciolare, fogli di cartone, ecc.). In aree caratterizzate dal passaggio di carichi pesanti concentrati non è consigliato l'utilizzo di prodotti a spessore ridotto.

Residenzial: kitchens, bathrooms, living rooms and other residential environments.
Light commercial: offices, offices open to the general public, waiting rooms, shops, public bathrooms, common apartment block areas, restaurant dining rooms, car showrooms, bars, cinemas, surgeries/clinics, hotel rooms and bathrooms. In areas subjected to forced traffic, or areas where chairs with hard plastic wheels are used, it is not advisable to use products with the LUX finishes.
Intensive commercial: common areas of shopping centres, hotel foyers, canteens, fast food restaurants, dance clubs, hospitals, schools, museums, places of worship, airports, stations.
Outdoor: mainly for external areas that require flooring with anti-slip characteristics.





NOTE

The LUX finishes are recommended, as well as for wall cladding, also for flooring in residential or light commercial areas that are not subjected to heavy traffic, where anti-slip characteristics are not required.

The occasional presence of small inconsistencies or little spots on the surface is to be considered a characteristic of the material and of its unique production process. If the product is laid in direct contact with external environments, it is recommended to use protective solutions to reduce scratches.

It is the installer's responsibility to protect the finished and clean tiling before the delivery to the client, by using appropriate protective materials (e.g. chipboard, cardboard sheets, etc.).

In areas that are subjected to heavy concentrated loads it is not recommended to use low thickness products.

LEGENDA LEGEND LEGENDE LÉGENDE	 RESIDENZIALE_RESIDENTIAL_ WOHNBEREICH_RÉSIDENTIEL	 COMMERCIALE LEGGERO LIGHT COMMERCIAL_LEICHTE GEWERBLICHE ANWENDUNGEN_ COMMERCIAL LÉGER	 COMMERCIALE INTENSIVO INTENSIVE COMMERCIAL_INTENSIVE GEWERBLICHE ANWENDUNGEN_ COMMERCIAL INTENSIF	 ESTERNI_OUTDOOR_ AUSSENBEREICHE_EXTÉRIEURS
EFFETTO MARMO_MARBLE LOOK_ MARMOR-OPTIK_EFFET MARBRE				
ETERNITY	SOFT - LUX	SOFT - LUX	-	-
TRILOGY	SOFT - LUX	SOFT - LUX	-	-
TRILOGY Zero.3	SOFT - LUX	SOFT - LUX	-	-
EFFETTO LEGNO_WOOD LOOK_ HOLZ-OPTIK_EFFET BOIS				
ASSI D'ALPE	NATURALE	NATURALE	NATURALE	-
BOREALIS	NATURALE	NATURALE	NATURALE	STRUTTURATO - EXT
CROSS WOOD	NATURALE	NATURALE	NATURALE	STRUTTURATO
KAIROS	NATURALE	NATURALE	NATURALE	STRUTTURATO - EXT
NUANCE	NATURALE	NATURALE	NATURALE	STRUTTURATO
EFFETTO CROMATICO_CHROMATIC LOOK_CHROMATISCHER EFFEKT_ EFFET CHROMATIQUE				
BLADE Zero.3	NATURALE	NATURALE	-	-
IQONIQIA	NATURALE	NATURALE	-	-
MUST Zero.3 - Be White / Be Black	SOFT - LUX	SOFT - LUX (solo Be White_only Be White)	-	-
MUST Zero.3 - Star White	SMOOTH	SMOOTH	-	-

Wohnbereich: Küchen, Badezimmer, Wohnzimmer und alle sonstigen Wohnbereiche. Leichte gewerbliche Anwendungen: Büroräume, öffentliche Büros, Wartezimmer, Geschäfte, öffentliche Toiletten, Gemeinschaftsbereiche in Mehrfamilienhäusern, Gaststätten, Autohäusern, Cafés, Kinos, Praxen/Kliniken, Hotelzimmern und Badezimmern. In Bereichen mit obligatorischen Durchgängen oder in denen Stühle mit Hartplastikrollen verwendet werden, ist der Einsatz von Produkten mit den Oberflächen LUX nicht zu empfehlen.
Intensive gewerbliche Anwendungen: Gemeinschaftsbereiche in Einkaufszentren, Hotelhallen, Kantinen, Fastfood-Restaurants, Diskotheken, Krankenhäusern, Schulen, Museen, Kultstätten, Flughäfen, Bahnhöfen.
Außenbereiche: Vor allem für Außenbereiche, in denen ein rutschfester Boden erforderlich ist.

ANMERKUNGEN

Die Oberfläche LUX wird nicht nur für Wandverkleidungen empfohlen, sondern auch für Böden in Wohn- bzw. Gewerbebereichen, die keiner hohen Belastung ausgesetzt sind und bei denen keine rutschhemmende Wirkung erforderlich ist. Das sporadische Vorhandensein von kleinen Unebenheiten oder Punkten auf der Oberfläche ist als ein Merkmal des Materials und der besonderen Verarbeitung zu betrachten. Wenn das Produkt in direktem Kontakt mit dem Außenbereich steht, ist es ratsam, Schutzmittel zu verwenden, um die Bildung von Kratzern zu verhindern. Der Fliesenleger ist dafür zuständig, den fertig verlegten, sauberen Fliesenbelag vor der Übergabe an den Bauherrn mit geeigneten Schutzmaterialien (z.B. Spanplatten, Pappe etc.) abzudecken. In Bereichen, die schwerer Belastung ausgesetzt sind, ist die Verwendung von Produkten mit reduzierter Stärke nicht empfehlenswert.

Résidentiel: cuisines, salles de bains, salons et tout autre espace à usage résidentiel.
Commercial léger: bureaux, bureaux ouverts au public, salles d'attente, magasins, toilettes publiques, espaces communs de logements collectifs, salles de restaurants, salons automobiles, bars, cinémas, cabinets médicaux/cliniques, chambres et salles de bains d'hôtels. Dans les zones caractérisées par des passages obligatoires, ou des lieux dans lesquels des chaises à roulettes en plastique dur sont utilisées, l'utilisation de produits avec une finition LUX n'est pas recommandée.
Commercial intensif: zones communes de centres commerciaux, halls d'hôtels, cantines, fast-foods, discothèques, hôpitaux, écoles, musées, lieux de culte, aéroports, gares.
Extérieurs: principalement pour les environnements extérieurs où un sol antidérapant est requis.

REMARQUES

En plus des revêtements, la finition LUX est également recommandée pour les sols dans les environnements résidentiels ou commerciaux légers peu soumis à des contraintes élevées, pour lesquels aucune prestation antidérapante n'est requise. La présence sporadique de petites irrégularités ou de points à la surface doit être considérée comme une caractéristique du matériau et de sa fabrication particulière. Si le produit est placé en contact direct avec l'extérieur, il est conseillé d'utiliser des solutions de protection afin d'éviter la formation de rayures. Il incombe au carreleur de protéger le dallage fini et propre avant la livraison au client, en utilisant des matériaux de protection appropriés (e.g. panneau aggloméré, feuille de carton etc.) Dans les zones à passage de charges lourdes concentrées, l'utilisation de produits d'épaisseur réduite n'est pas recommandée.

Tabelle calibri

Size table_Formattabellen_Tableaux des calibres

FUGA MINIMA CONSIGLIATA 2 mm_RECOMMENDED MINIMUM JOINT 2 mm_MINIMALE EMPFOHLENE FUGE 2 mm_JOINT MINIMUM CONSEILLÉ 2 mm

CALIBRO CALIBRE KALIBER CALIBRE	120x120 cm RECT		60x120 cm RECT		60x60 cm RECT		40x60 cm RECT		30x60 cm RECT		40x120 cm RECT		30x120 cm RECT		20x120 cm RECT	
O	1202,0	1202,0	600,0	1202,0	600,0	600,0	399,3	600,0	299,0	600,0	399,3	1202,0	299,0	1202,0	198,7	1202,0
P	1198,0	1198,0	598,0	1198,0	598,0	598,0	398,0	598,0	298,0	598,0	398,0	1198,0	298,0	1198,0	198,0	1198,0
Q	1195,0	1195,0	596,0	1195,0	596,0	596,0	396,7	596,0	297,0	596,0	396,7	1195,0	297,0	1195,0	197,0	1195,0
R	-	-	-	-	595,0	595,0	395,3	595,0	296,0	595,0	-	-	-	-	-	-

CALIBRO CALIBRE KALIBER CALIBRE	90x90 cm RECT		60x90 cm RECT		45x90 cm RECT		22,5x90 cm RECT		30x180 cm RECT		20x180 cm RECT	
O	901,0	901,0	600,0	901,0	449,5	901,0	223,8	901,0	298,0	1803,0	198,7	1803,0
P	898,0	898,0	598,0	898,0	448,0	898,0	223,0	898,0	297,0	1799,0	198,0	1799,0
Q	895,0	895,0	596,0	895,0	446,5	895,0	222,3	895,0	296,0	1795,0	197,0	1795,0

FUGA MINIMA CONSIGLIATA 3 mm_RECOMMENDED MINIMUM JOINT 3 mm_MINIMALE EMPFOHLENE FUGE 3 mm_JOINT MINIMUM CONSEILLÉ 3 mm

CALIBRO CALIBRE KALIBER CALIBRE	60,3x60,3 cm NOT RECT	30x60,3 cm NOT RECT
F	598,2 x 598,2	297,6 x 598,2
G	600,6 x 600,6	298,8 x 600,6
J	603,0 x 603,0	300,0 x 603,0
K	605,4 x 605,4	301,2 x 605,4
Y	607,8 x 607,8	302,4 x 607,8

FUGA MINIMA CONSIGLIATA 4 mm_RECOMMENDED MINIMUM JOINT 4 mm_MINIMALE EMPFOHLENE FUGE 4 mm_JOINT MINIMUM CONSEILLÉ 4 mm

CALIBRO CALIBRE KALIBER CALIBRE	20x90,5 cm NOT RECT	20x121,5 cm NOT RECT
Q	198,4 x 900,8	-
S	198,8 x 902,6	-
T	199,2 x 904,4	-
X	199,6 x 906,2	199,6 x 1210,6
U	200,0 x 908,0	200,0 x 1213,0
A	200,4 x 909,8	200,4 x 1215,4
V	-	200,8 x 1217,8
B	-	201,2 x 1220,2

Tutti i calibri sono in mm_All calibres are in mm_Alle Kaliber sind in mm_Tous les calibres sont en mm

FUGA MINIMA CONSIGLIATA 4 mm_RECOMMENDED MINIMUM JOINT 4 mm_MINIMALE EMPFOHLENE FUGE 4 mm_JOINT MINIMUM CONSEILLÉ 4 mm (The Place - Pierre des Rêves)

CALIBRO CALIBRE KALIBER CALIBRE	20x20 cm NOT RECT	20x30,2 cm NOT RECT	20x40,4 cm NOT RECT
I	197,6 x 197,6	197,6 x 298,4	197,6 x 399,2
Q	198,4 x 198,4	198,4 x 299,6	198,4 x 400,8
T	199,2 x 199,2	199,2 x 300,8	199,2 x 402,4
U	200,0 x 200,0	200,0 x 302,0	200,0 x 404,0
V	200,8 x 200,8	200,8 x 303,2	200,8 x 405,6
W	201,6 x 201,6	201,6 x 304,4	201,6 x 407,2

FUGA MINIMA CONSIGLIATA 10 mm_RECOMMENDED MINIMUM JOINT 10 mm_MINIMALE EMPFOHLENE FUGE 10 mm_JOINT MINIMUM CONSEILLÉ 10 mm (Bioarch - Pietre di Fanes)

CALIBRO CALIBRE KALIBER CALIBRE	20x20 cm NOT RECT	20x30,5 cm NOT RECT	20x41 cm NOT RECT
B	197,6 x 197,6	197,6 x 301,4	197,6 x 405,2
E	200,0 x 200,0	200,0 x 305,0	200,0 x 410,0
M	202,4 x 202,4	202,4 x 308,6	202,4 x 414,8

Zero.3 SPESSORE 3,5 mm_THICKNESS 3,5 mm_STÄRKE 3,5 mm_ÉPAISSEUR 3,5 mm

Per tutti i formati di Zero.3 3plus il valore nominale indicato coincide con la dimensione di fabbricazione

For all Zero.3 3plus sizes the rated size indicated corresponds with the work size
Bei allen Formaten von Zero.3 3plus stimmt der angegebene Nennwert mit dem Herstellungsformat überein
Pour tous les formats de Zero.3 3plus la valeur nominale indiquée correspond aux dimensions de fabrication

Zero.3 SPESSORE 5,5 mm_THICKNESS 5,5 mm_STÄRKE 5,5 mm_ÉPAISSEUR 5,5 mm

CALIBRO CALIBRE KALIBER CALIBRE	50x100 cm RECT		100x100 cm RECT		100x250 cm RECT		100x300 cm RECT	
F	497	997	997	997	997	2500	997	3000

Zero.3 SPESSORE 6 mm_THICKNESS 6 mm_STÄRKE 6 mm_ÉPAISSEUR 6 mm

CALIBRO CALIBRE KALIBER CALIBRE	60x120 cm RECT		120x120 cm RECT		120x278 cm RECT	
P	598	1198	1198	1198	1198	2780

Tutti i calibri sono in mm_All calibres are in mm_Alle Kaliber sind in mm_Tous les calibres sont en mm

Suggerimenti per la posa

Laying suggestions_Empfehlungen für das Verlegen_Conseils pour la pose

È compito del posatore controllare sempre il materiale prima della posa. Stendere a terra alcune piastrelle (circa 3 mq) e verificarne accuratamente le specifiche tecniche ed estetiche d'insieme. Riferimento norma UNI 11493.

POSA

Con collanti indicati per prodotti a bassa porosità. Dopo aver effettuato la stuccatura, rimuovere in breve tempo con frequenti lavaggi di spugna ed acqua gli eccessi fino alla totale pulizia del pavimento. Successivamente fare lavaggio acido e alcalino come da istruzioni Panaria. È responsabilità del posatore provvedere sempre alla protezione della piastrellatura finita e pulita, prima della consegna al committente, tramite appositi materiali protettivi (es. pannelli in truciolare, fogli di cartone, etc.). Riferimento norma UNI 11493. Per la realizzazione di tagli interni e a "L" si consiglia di arrotondare i vertici dell'apertura utilizzando punte con diametro di almeno 5 mm, per ridurre il rischio di rottura o fessurazioni, nel materiale già posato. È consigliabile posare il gres porcellanato Panaria utilizzando livellatori meccanici. Va però evidenziato che in commercio sono disponibili molteplici modelli, alcuni dei quali per le loro modalità di utilizzo, possono risultare non indicati per prodotti ceramici con particolari finiture. In caso di necessità si prega di contattare il Technical Department Panariagroup prima dell'installazione. Per le indicazioni di posa di Zero.3 far riferimento al Manuale Tecnico Zero.3.

SOTTOFONDO

Massetto cementizio.

DIMENSIONE FUGA

Indicativamente 2 mm per i prodotti rettificati e 4 mm per i prodotti non rettificati posati negli spazi interni. Salvo diversa indicazione dei Codici di Posa Nazionali. La larghezza delle fughe deve comunque essere decisa dalla Direzione Lavori. Prevedere nella pavimentazione idonei giunti perimetrali a contatto con elementi strutturali verticali (muri, colonne, scale ...) ed idonei giunti di dilatazione.

COLORE FUGA

Grigio cemento o colore in tono con la piastrella. Prima di usare stucchi colorati a grana fine su prodotti lappati, levigati o spazzolati, fare sempre un test di prova. Se il pigmento colorato è molto tenace la rimozione potrebbe risultare molto difficile.

The person in charge of installation must check all material before installing it. Place some tiles on the floor (approx. 3 m²) and check the overall technical and aesthetic characteristics with particular care.

LAYING

With adhesives for products with a low porosity. After grouting, remove any excess product as quickly as possible by repeatedly washing the area with a sponge and water. Then perform acid washing, as instructed by Panaria. It is the installer's responsibility to protect the finished and clean tiling before the delivery to the client, by using appropriate protective materials (e.g. chipboard, cardboard sheets, etc.).

To create interior and "L" cuts it is advisable to round off the corners of the opening using drill bits with a diameter of at least 5 mm to reduce the risk of breakage or cracks in the already laid material. It is advisable to lay Panaria porcelain stoneware using mechanical levellers. However, it should be noted that many models are available on the market, some of which, due to their operating methods, may not be suitable for ceramic products with particular finishes. If necessary, please contact the Panariagroup Technical Department before installation. For instructions on laying Zero.3, refer to the Zero.3 Technical Manual.

SUBSTRATE

Compact cement bed.

JOINT WIDTH

Approximately 2 mm for rectified tiles and 4 mm for non-rectified tiles laid in interior spaces. The width of grout joints must be established by the installation supervisor, unless grout widths are regulated by national laying standards. Plan in the flooring for suitable perimeter joints in contact with vertical structural elements (walls, columns, stairs ...) and suitable expansion joints.

GROUT COLOR

Grey or matching the colour of the tile. Before using fine-grain coloured grout on lapped, polished or brushed products, always perform a test. If the coloured pigment stains, it may be very difficult to remove.

Es ist Aufgabe des Fliesenlegers, das Material vor dem Verlegen stets zu kontrollieren. Einige Fliesen auf den Boden legen (circa 3 m²) und sorgfältig die technischen und optischen Eigenschaften des Ganzen überprüfen.

VERLEGUNG

Mit Klebern für Produkte mit geringer Porosität. Nach dem Verlegen das überschüssige Material schnell durch häufiges Wischen mit Schwamm und Wasser das überschüssige Material entfernen, bis der Boden vollständig sauber ist. Anschließend eine saure und alkalische Reinigung nach den Anweisungen von Panaria vornehmen. Der Fliesenleger ist dafür zuständig, den fertig verlegten, sauberen Fliesenbelag vor der Übergabe an den Bauherrn mit geeigneten Schutzmaterialien (z.B. Spanplatten, Pappe etc.) abzudecken. Für Innen- und „L“-Schnitte ist es ratsam, die Kanten der Öffnung mit Bohrern mit einem Durchmesser von mindestens 5 mm abzurunden, um Brüche oder Risse im bereits verlegten Material zu vermeiden. Feinsteinzeug von Panaria sollte mithilfe von mechanischen Richtmaschinen verlegt werden. Es ist jedoch zu beachten, dass auf dem Markt eine Vielzahl von Modellen erhältlich ist. Einige davon könnten aufgrund der Art und Weise, wie sie verwendet werden, für Keramikprodukte mit speziellem Finish nicht geeignet sein. Bei Bedarf bitte vor dem Verlegen mit der Technischen Abteilung von Panariagroup Rücksprache halten. Für Anweisungen zum Verlegen von Zero.3 bitte im Technischen Handbuch von Zero.3 nachlesen.

UNTERGRUND

Kompakter Zementuntergrund.

FUGENBREITE

Environ 2 mm pour les carreaux rectifiés et 4 mm pour les carreaux pas rectifiés posés dans les espaces intérieurs. Sauf indication contraire contenue dans les Normes de Pose Nationales, la dimension des joints doit dans tous les cas être définie par le directeur des travaux. Prévoir dans le dallage des joints adéquats sur le périmètre au niveau des éléments structurels (murs, colonnes, escaliers...) et des joints de dilatation adéquats.

FUGENFARBE

Grau oder auf die Fliesenfarbe abgestimmt. Bevor farbige Fugenfüller mit feiner Körnung auf geläpften, geschliffenen und gebürsteten Produkten eingesetzt werden ist stets eine Probe vorzunehmen. Wenn das Farbpigment sehr resistent ist, könnte der Fugenfüller sehr schwer zu entfernen sein.

Le poseur doit toujours contrôler le matériel avant la pose. Poser quelques carreaux (environ 3 m²) sur le sol sans les coller et en contrôler soigneusement les spécifications techniques et esthétiques générales.

POSE

Avec des colles adaptées aux produits à faible porosité. Après avoir effectué le jointoiment, éliminer rapidement les excès par des lavages fréquents avec une éponge et de l'eau jusqu'à ce que le sol soit complètement propre. Effectuer ensuite le lavage acide et alcalin selon les instructions fournies par Panaria. Il incombe au carreleur de protéger le dallage fini et propre avant la livraison au client, en utilisant des matériaux de protection appropriés (par ex. panneau aggloméré, feuille de carton etc.) Sous-couche: lit de ciment compact. Pour réaliser des découpes internes en « L » nous conseillons d'arrondir les sommets de l'ouverture avec des forets de 5 mm de diamètre minimum, afin de réduire le risque de rupture ou de fissure du matériau déjà en place. Nous conseillons de poser le grès cérame Panaria en utilisant des niveleuses mécaniques. Nous faisons remarquer qu'il existe dans le commerce plusieurs modèles, dont certains peuvent, à cause de leur mode d'emploi, ne pas être indiqués pour les produits en céramique ayant des finitions particulières. En cas de besoin, veuillez contacter le Service technique de Panariagroup avant de procéder à l'installation. Pour les indications de pose de Zero.3, consultez le Manuel technique de Zero.3.

SOUS-COUCHE

Lit de ciment compact.

DIMENSION JOINT

Environ 2 mm pour les carreaux rectifiés et 4 mm pour les carreaux pas rectifiés posés dans les espaces intérieurs. Sauf indication contraire contenue dans les Normes de Pose Nationales, la dimension des joints doit dans tous les cas être définie par le directeur des travaux. Prévoir dans le dallage des joints adéquats sur le périmètre au niveau des éléments structurels (murs, colonnes, escaliers...) et des joints de dilatation adéquats.

COULEUR JOINT

Joint gris ou dans la teinte du carreau. Toujours effectuer un test avant d'utiliser des stucs colorés à granulométrie fine sur des produits poncés, polis et brossés. L'élimination d'un pigment très prononcé pourrait s'avérer difficile.

Gradino Plus. Informazioni per la posa

Step tread plus. Laying information_Plus-stufen. Informationen für die Verlegen_

Nez de marche plus. Informations pour la pose

Effettuare sempre la posa con adesivo.

Per la posa su sottofondi cementizi utilizzare adesivi elastici di classe S2 secondo EN 12004. Nel caso di posa su altri supporti (es. legno, truciolare...) contattare i fornitori per la scelta dell'adesivo più idoneo. Verificare che il sottofondo sia stabile, planare e pulito. Gli strati cementizi (massetti, calcestruzzo, strati di livellamento/pendenza...) devono essere stagionati, cioè devono aver esaurito i fenomeni di ritiro. Evitare la presenza di acqua sul sottofondo.

Nel caso in cui la pavimentazione in esercizio sarà a contatto con l'acqua (ambienti esterni, centri benessere, docce, spogliatoi...) è necessario: • realizzare sottofondi con pendenza di almeno l'1% (1 cm per ogni metro); • applicare idonei impermeabilizzanti sulla superficie del sottofondo; • miscelare gli stucchi con idonei laticci che riducano la porosità delle fughe. NON LASCIARE VUOTI sotto ai Gradini Plus, posare con "doppia spalmatura" anche nella parte verticale dei pezzi. Il bordo verticale del Gradino Plus deve essere distanziato di alcuni mm (almeno 3-4 mm) dal sottofondo e lo spazio vuoto deve essere riempito con collante, v. figure. Calpestare i Gradini Plus e riempire le fughe solo quando l'adesivo ha fatto presa secondo le indicazioni riportate dai fabbricanti. Posare sempre con la fuga, che dovrà avere idonee dimensioni e comunemente calcolata dal progettista. Prevedere nella pavimentazione i giunti perimetrali a contatto con elementi strutturali verticali (muri, colonne...) ed idonei giunti di dilatazione.

Evitare sistemi rigidi: • volendo rivestire la parte verticale degli scalini ("alzata"), posare il materiale ben distanziato dai Gradini Plus. Evitare di pulire i Gradini Plus con prodotti chimici aggressivi, che potrebbero danneggiare la resina epossidica utilizzata per il loro incollaggio. In caso di posa a bordo piscina, il Gradino Plus (sia pedata che parte verticale del pezzo) deve essere incollato direttamente solo su sottofondi cementizi. Non incollare il Gradino Plus sopra la vasca di contenimento dell'acqua (plastica, vetroresina, etc.).

Posa A

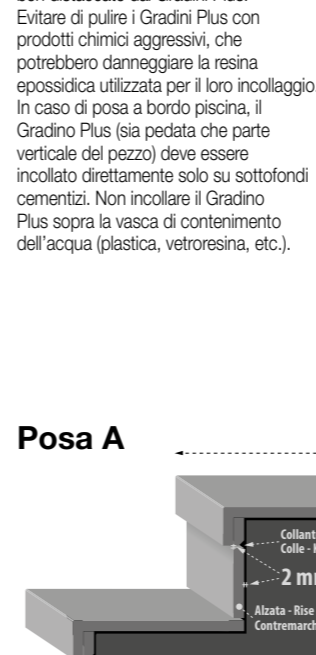

Posa B

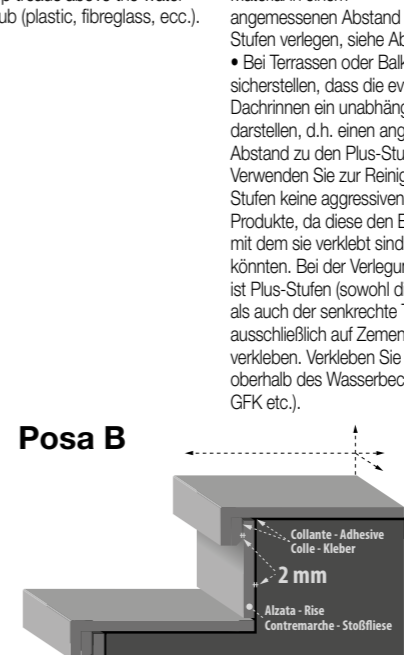

Always lay using adhesive.

When laying on cement bases use elastic class S2 EN 12004 compliant adhesive. When laying on other bases (e.g. wood, chipboard...) contact suppliers for the choice of the best adhesive. Check that the base is stable, flat and clean. Cement layers (screed, concrete, levelling/sloping layers...) must be cured, meaning they must have withdrawn completely. Avoid any water on the base. If flooring in use is in contact with water (exteriors, wellness centres, showers, changing rooms...) you need to:

- create bases with a slope of at least 1% (1 cm for each metre);
- apply suitable waterproofing to the base;
- mix the grouting product with suitable latexes to make them waterproof. DO NOT LEAVE EMPTY SPACES under the "Plus" Steps; lay by "double buttering" even for vertical edges. The vertical parts of "Plus" Steps must be spaced a few mm (at least 3-4 mm) from the base and the empty space must be filled with adhesive, see pictures. Walk on the "Plus" Steps and only fill grouts when the adhesive has set following manufacturer instructions. Always lay with grout lines of the right size, calculated by the designer. Plan for perimeter joints in flooring coming into contact with vertical structural elements (walls, columns...) and suitable expansion joints. Avoid rigid systems:

- If you want to cover the vertical part of steps ("riser"), lay the material the right distance from the "Plus" Steps, as shown in the pictures.
- For terraces and balconies, makes sure any gutters present are detached, i.e. separated from the "Plus" Steps. Avoid cleaning Plus step treads with aggressive chemical products, which could damage the epoxy resin used to assemble them. In the case of poolside installation, Plus step treads (both the tread and vertical part of the step tread) must be adhered directly to the cement subfloor. Do not install Plus step treads above the water containment tub (plastic, fibreglass, ecc.).

Zum Verlegen immer Kleber verwenden.

Zum Verlegen auf zementhaltigem Untergrund elastische Kleber der Klasse S2 gemäß EN 12004 verwenden. Wenden Sie sich beim Verlegen auf anderen Unterlagen (z.B. Holz, Spanplatten usw.) für die Wahl des geeigneten Klebers an die den Händler. Prüfen Sie, dass der Untergrund stabil, eben und sauber ist. Die zementhaltigen Schichten (Estrich, Betonuntergrund, Nivellierschicht bzw. Gefälle, usw.) müssen abgelagert sein, d.h. die Schrumpfung muss abgeschlossen sein. Es darf sich kein Wasser auf dem Untergrund befinden. Sollte der zu verlegende Fußboden in Kontakt mit Wasser gelangen (Außenbereiche, Wellness-Center, Duschen, Umkleieräume usw.) ist Folgendes zu beachten:

- Einen Untergrund einem Gefälle von mindestens 1% herstellen (1 cm pro Meter);
- Geeignete Dichtstoffe auf die Oberfläche des Untergrunds aufbringen;
- Die Gipsmörtel mit geeignetem Latex mischen, um die Durchlässigkeit der Fugen zu verringern.

KEINE LEERRÄUME unter den Plus-Stufen HINTERLASSEN; auch den vertikalen Abschnitt der Elemente mit "Doppelbeschichtung" verlegen. Die vertikale Kante der Plus-Stufen muss einige mm Abstand (mind. 3-4 mm) zum Untergrund aufweisen; dabei ist der Leerraum mit Kleber zu füllen, siehe Abbildungen. Erst dann die Plus-Stufen betreten und die Fugen erst verschließen, nachdem der Kleber entsprechend der Herstellerangaben gehärtet ist. Immer mit der Fußbodenverlegung die umlaufenden Fugen, welche mit vertikalen Konstruktionselementen (Mauern, Säulen, usw.) in Kontakt stehen, sowie die Dehnungsfugen mit ein. Vermeiden Sie starre Systeme:

- Bei der Verkleidung des vertikalen Abschnitts der Stufen ("Setzstufe") das Material in einem angemessenen Abstand zu den Plus-Stufen verlegen, siehe Abbildungen.
- Bei Terrassen oder Balkonen sicherstellen, dass die evtl. vorhandenen Dachrinnen ein unabhängiges System darstellen, d.h. einen angemessenen Abstand zu den Plus-Stufen aufweisen. Verwenden Sie zur Reinigung der Plus-Stufen keine aggressiven chemischen Produkte, da diese den Epoxydharz, mit dem sie verklebt sind, beschädigen könnten. Bei der Verlegung am Poolrand ist Plus-Stufen (sowohl die Trittfäche als auch der senkrechte Teil) direkt und ausschließlich auf Zementuntergrund zu verkleben. Verkleben Sie Plus-Stufe nicht oberhalb des Wasserbeckens (Kunststoff, GFK etc.).

Effectuer toujours la pose en utilisant de la colle.

Pour la pose sur les sous-couches en ciment, utiliser des colles élastiques de classe S2 conformes à la norme EN 12004. En cas de pose sur d'autres supports (ex. bois, aggloméré...), contactez les fournisseurs pour le choix de la colle la plus appropriée. Vérifier que la sous-couche est stable, plane et propre. Les temps de séchage du support (chapes, béton armé, produits de ragréage...) doivent être parfaitement respectés c'est-à-dire que les phénomènes de retrait doivent être terminés.

Éviter la présence d'eau sur la sous-couche. Si le sol à carrelé doit entrer en contact avec l'eau (pose en extérieur, centres bien-être, douches, vestiaires...) il est nécessaire:

- de réaliser une sous-couche avec une pente d'au moins 1% (1 cm/mètre)
- d'appliquer des imperméabilisants appropriés sur la sous-couche
- de mélanger les mortiers avec des latex appropriés qui réduisent la porosité des jointoiments.

NE PAS LAISSER DE VIDES sous les nez de marche "Plus"; appliquer la colle avec la technique du double encollage (support et envers des carreaux), ainsi que sur le bord vertical des carreaux. Le bord vertical des nez de marche "Plus" doit être à une distance de quelques mm (au moins 3-4 mm) de la sous-couche et l'espace vide doit être rempli avec de la colle, voir les figures. Ne piétiner les nez de marche "Plus" et ne remplir les joints que lorsque la colle a déjà fait prise, selon les indications fournies par les fabricants. Poser toujours avec un joint dont les dimensions seront calculées par l'architecte. Prévoir sur le carrelage des joints périphériques aux points de contact avec les éléments structurels verticaux (mur, colonnes...) et des joints de dilatation opportuns. Éviter les systèmes rigides:

- si l'on désire carrelé la partie verticale des marches (contre-marche), poser les carreaux à une certaine distance des nez de marche "Plus" comme le montrent les figures.
- Pour les terrasses et les balcons, s'assurer que les gouttières sont totalement indépendantes, c'est-à-dire bien séparées des nez de marche "Plus". Éviter de nettoyer les nez de marche Plus avec des produits chimiques agressifs, qui pourraient endommager la résine époxy utilisée pour leur assemblage. En cas de pose au bord d'une piscine, les nez de marche Plus (aussi bien le plat de marche que la partie verticale de la pièce) doivent être collés directement sur la base en ciment. Ne pas coller le nez de marche Plus sur la vasque qui contient l'eau (plastique, fibre de verre, etc.).

Informazioni per la pulizia e la manutenzione

Cleaning and maintenance information_Informationen zur reinigung und pflege_
Informations sur le nettoyage et l'entretien

Pulizia straordinaria

Extra cleaning_Sonderreinigung_Nettoyage extraordinaire

Viene effettuata per rimuovere macchie o residui particolarmente vecchi o resistenti. Prima dell'uso fare sempre test preventivi (su una piastrella non posata), in particolare su **Lappati e Levigati**. Nella tabella sotto sono indicati detergenti efficaci a seconda del tipo di macchia.

This procedure is carried out to remove stains or residues that are particularly old or stubborn. Make sure to always perform a precautionary test before using the product (on a tile that is not laid), especially for **Honed or Polished** products. The table shown below indicates the detergents that are effective according to the type of stains.

Sie wird ausgeführt, um besonders alte oder hartnäckige Flecken oder Reste zu entfernen. Vor der Anwendung immer Tests vornehmen (auf einer nicht verlegten Fliese), insbesondere bei **geläpften und polierten** Fliesen. In der unten aufgeführten Tabelle sind wirksame Reinigungsmittel je nach Fleckenart angegeben.

Il sert à éliminer les taches ou les résidus particulièrement anciens ou tenaces. Effectuer toujours des tests avant emploi (sur un carreau non posé), notamment sur les produits **Rodés et Polis**. Veuillez trouver dans le tableau ci-après des détergents efficaces en fonction du type de tache.

RESIDUO DA RIMUOVERE RESIDUE TO BE REMOVED RÜCKSTÄNDE RÉSIDU À ENLEVER	TIPO DI DETERGENTE DETERGENT TYPE REINIGERTYP TYPE DE DÉTERGENT	NOME DETERGENTE (PRODUTTORE) DETERGENT NAME (MANUFACTURER) BEZEICHNUNG DES REINIGERS (HERSTELLER) NOM DU DÉTERGENT (FABRICANT)
Grassi, polvere da calpestio, pulizie di fondo Grease, dust footmarks, base cleaning Fette, Trittstaub, grundreinigung Graises, dépôts de poussières, grands nettoyyages	Polifunzionali, a base alcalina (1) Multipurpose, alkaline-based (1) Polyfunktioneil mit Alkalibasis (1) Alcalines universels (1)	PS87 Pro (Fila) - Intensivreiniger (Lithofin) Hmk R55 (Hmk) - Taski R20-strip (Johnsondversey) Deterflash (Geal) - Deep Degreaser (Faber Chimica) Bonadecon / Bdecon (Bonasystems Italia) Ultracare HD Cleaner (Mapei)
Caffè, Coca-Cola, succhi di frutta Coffee, Coke, fruit juices Kaffee, Coca Cola, Obstsäfte Café, Coca-Coca, jus de fruits	Polifunzionali, a base alcalina (1) Multipurpose, alkaline-based (1) Polyfunktioneil mit Alkalibasis (1) Alcalines universels (1)	Coloured Stain Remover (Faber Chimica) PS87 Pro (Fila) - Super Deterjet (Geal) Ultracare HD Cleaner (Mapei) Candeggina_Bleach_Bleichmittel_Eau de javel (Vari produttori_Several manufacturers_Verschiedene Hersteller_Producteurs divers)
Vino Wine Wein Vin	Ossidante Oxidizing agent Oxydierend Oxydant	Oxidant (Faber Chimica) Candeggina_Bleach_Candeggina_Eau de javel (Vari produttori_Several manufacturers_Verschiedene Hersteller_Producteurs divers)
Depositi calcarei Calcareous deposits Kalkrückstände Dépôts calcaires	A base acida (1) Acid-based (1) Mit Säurebasis (1) Acide (1)	Viakal (Procter & Gamble) Ultracare Acid Cleaner (Mapei)
Ruggine Rust Rost Rouille	A base acida (1) Acid-based (1) Mit Säurebasis (1) Acide (1)	Ultracare Acid Cleaner (Mapei) Acido muriatico diluito_Diluted hydrochloric acid_ Verdünnte Chlorwasser-stoffsäure_Acide muriatique dilué (Vari produttori_Several manufacturers_Verschiedene Hersteller_Producteurs divers)
Inchiostri, pennarello Inks, felt-tipped pen Tinten, Filzstift Encres, feutres	A base solvente Solvent-based Mit Lösungsmittel À base de solvant	Diluente Nitro, Acquaragia_Nitro thinner, turpentine_Nitroverdüner, Terpentin_Diluant, térébenthine (Vari produttori_Several manufacturers_Verschiedene Hersteller_Producteurs divers) Coloured Stain Remover (Faber Chimica)
Pneumatici, segni di gomma, di metalli, di matita Tire traces, stains from rubber, metal or pencil Reifen, Gummiflecken, Metall, Bleistift Pneus, traces de caoutchouc, de métaux, de crayon	Pasta abrasiva (1) Abrasive paste (1) Scheuermittel (1) Pâte abrasive (1)	Vim Clorex (2) (Guaber) Polishing Cream (2) (Faber Chimica) Strong Remover (3) (Faber Chimica) Detergum (3) (Zep Italia)
Sporco delle fughe Tile joint stains Fugenschmutz Saleté des joints	Specifico Specific Spezifisch Spécifique	Fuganet (Fila) Fugenreiniger (Lithofin) Ultracare Grout Cleaner (Mapei)

(1) Fare test preventivo su materiali Lappati e Levigati.
(2) Indicato per materiali Lappati e Levigati.
(3) Non usare su prodotti Lappati, usare con molta attenzione sui Levigati.
Salvo diversa indicazione di Panaria, seguire attentamente le modalità d'uso indicate sulle confezioni dai fabbricanti.

(1) Perform a precautionary test on Honed or Polished materials.
(2) Suitable for Honed or Polished materials.
(3) Do not use it on Honed products, use with the utmost caution on Polished products.
Unless otherwise indicated by Panaria, follow the instructions indicated on the manufacturer's package very carefully.

(1) Vortesten auf geläpften und polierten Materialien.
(2) Für geläppte und polierte Materialien.
(3) Nicht auf geläpften Produkten verwenden, sehr vorsichtig auf polierten Materialien verwenden.
Außer bei anders lautenden Angaben von Panaria werden die Gebrauchsanweisungen der Produkthersteller befolgt.

(1) Effectuer des tests avant emploi sur les produits Rodés et Polis.
(2) Recommandé pour les produits Rodés et Polis.
(3) Ne pas utiliser sur les produits Rodés, utiliser sur les produits polis en faisant très attention.
Sauf indication contraire de Panaria, suivre scrupuleusement le mode d'emploi signalé par le fabricant sur l'emballage.

Pulizia decori

Cleaning decorations_Reinigung des Fliesendekors_Nettoyage décors

Utilizzare detergenti NEUTRI e diluiti.
NON UTILIZZARE ASSOLUTAMENTE:
- Ceranti e/o impregnanti;
- Detergenti acidi o alcalini;
- Paste abrasive;
- Spazzole o spugne abrasive

Use NEUTRAL, diluted detergents.
NEVER USE:
- Waxing and impregnating agents;
- Acid or alkaline detergents;
- Abrasive pastes;
- Abrasive brushes or sponges.

Verwenden Sie ausschließlich NEUTRALE und verdünnte Reinigungsmittel.
VERWENDEN SIE AUF KEINEN FALL:
- Wachs- und/oder Imprägniermittel;
- Ätzende oder alkalische Reinigungsmittel;
- Scheuerpasten-und Pulver;
- Grobe Bürsten oder abrasive Schwämme.

Utiliser des détergents NEUTRES et dilués.
NE SURTOUT PAS UTILISER:
- Agents cirants et/ou agents d'imprégnation;
- Des détergents acides ou alcalins;
- Des produits abrasifs;
- Des brosses ou des éponges abrasives.

Rimozione di patine lucide

Removing glossy glaze_Entfernen von Glänzenden Schichten_Élimination des films brillants

Nei normali detergenti in commercio sono a volte contenute cere o additivi lucidanti che, lavaggio dopo lavaggio, depositano sul pavimento **patine lucide**, causa di noiose alonature. Patine di questo tipo possono essere depositate anche da detergenti disinfettanti a base alcolica e stucchi per le fughe. Semplici alimenti come Coca Cola, vino, acqua, etc., cadendo sul pavimento tolgono questa patina lucida e ripristinano l'aspetto originale più opaco delle piastrelle. In mezzo al pavimento più lucido, le zone senza cera appaiono come aloni opachi, in realtà sono le uniche parti pulite del pavimento. In questi casi bisogna:
1. Prima di tutto togliere la patina lucida da tutto il pavimento (vedi tabella seguente);
2. Poi, per le pulizie quotidiane, utilizzare detergenti neutri che non contengano né cere né patine lucidanti (vedi paragrafo precedente "pulizie quotidiane/ordinarie").

Standard detergents that are available in the market sometimes contain waxes or polish additives that, wash after wash, deposit **glossy glaze** on the floor and causes annoying marks. Patinas of this type can also be deposited by alcohol-based disinfectant detergents and grouting for joints. When simple foods such as Coke, wine, water, etc., fall on the floor, they remove this type of glossy glaze and restore the **original appearance** of the tiles (a more opaque look). In the middle of the shinier floor, the areas without wax appear as opaque marks, but they are actually the only clean parts of the floor. In these cases, the following must be done:
1. First of all, remove the glossy glaze from the entire floor (see table below);
2. Then, for daily cleaning, use neutral detergents that do not contain wax or polishing glaze (see the previous paragraph: "daily/standard cleaning").

In den normalen handelsüblichen Reinigungsmitteln sind manchmal Wachse oder **glänzende** Zusätze enthalten, die nach jeder Reinigung glänzende Schichten auf dem Boden hinterlassen, die hartnäckige Streifen verursachen. Beläge dieser Art können auch durch desinfizierende Reinigungsmittel auf Alkoholbasis und Fugenmassen entstehen. Einfache Lebensmittel wie Coca Cola, Wein, Wasser usw. entfernen durch Fallen auf den Boden diese glänzende Schicht und bringen den matten **Originalzustand** der Fliesen wieder zum Erscheinen. Auf dem glänzenden Teil des Bodens erscheinen die Bereiche ohne Wachs als matte Schatten, eigentlich handelt es sich um die einzigen sauberen Bereiche des Bodens. In diesen Fällen muss man:
1. Zuerst die glänzende Schicht vom ganzen Boden entfernen (siehe folgende Tabelle);
2. Dann zur täglichen Reinigung neutrale Reinigungsmittel verwenden, die keine Wachse oder glänzende Zusätze enthalten (siehe vorheriger Abschnitt „tägliche/regelmäßige Reinigung“).

Les nettoyyants ordinaires disponibles dans le commerce contiennent souvent des cires ou des additifs de cirage qui, lavage après lavage, déposent sur le revêtement de sol des **films brillants** qui entraînent la formation d'auroles difficiles à éliminer. Des dépôts de ce genre peuvent être dus à des détergents désinfectants à base d'alcool et à des enduits pour joint de carrelage. Si de simples boissons, comme le Coca-Cola, le vin, l'eau, etc., sont renversées sur le sol, ce film brillant part et les carreaux reprennent leur **aspect original** plus mat. Au milieu du sol plus brillant, les zones sans cire apparaissent comme des auroles mates mais, en réalité, ce sont les seules parties propres du revêtement de sol. Dans ce cas, il faut:
1. avant toute chose, éliminer le film brillant sur l'ensemble du revêtement de sol (voir tableau ci-après) ;
2. ensuite, pour le nettoyage journalier, utiliser des détergents neutres qui ne contiennent pas de cire ni de films brillants (voir paragraphe précédent « nettoyyages journaliers/ordinaires »).

RESIDUO DA RIMUOVERE: Patine lucide	RESIDUE TO BE REMOVED: Glossy glaze	ZU ENTFERNENDER REST: Glänzende Schichten	RÉSIDU À ENLEVER: Film brillant
TIPO DI DETERGENTE: Debolmente acidulo	TYPE OF DETERGENT: Weak acidic	REINIGUNGSMITTELS: Leicht sauer	TYPE DE DÉTERGENT: Faiblement acidulé
NOME DETERGENTE (PRODUTTORE)	DETERGENT'S NAME (MANUFACTURER)	NAME REINIGUNGSMITTEL (HERSTELLER)	NOM DES DÉTERGENTS (FABRICANT)
Tile Cleaner puro (*) (Faber Chimica)			

(*) Non seguire le indicazioni sulla confezione, seguire le istruzioni mostrate nel video al seguente link: <https://www.youtube.com/watch?v=4Kqe-CJlb5s>

(*) Do not follow the instructions on the package, follow the instructions shown in the video at the following link: <https://www.youtube.com/watch?v=4Kqe-CJlb5s>

(*) Die Angaben auf der Verpackung nicht befolgen, den im Video gezeigten Anweisungen unter diesem Link folgen: <https://www.youtube.com/watch?v=4Kqe-CJlb5s>

(*) Ne pas suivre le mode d'emploi signalé sur l'emballage, suivre les instructions données dans la vidéo qui se trouve au lien suivant: <https://www.youtube.com/watch?v=4Kqe-CJlb5s>

Non utilizzare cere su gres porcellanato Panaria.

Do not use wax on Panaria porcelain stoneware.

Keine Wachse auf Feinsteinzeug von Panaria verwenden.

Ne pas utiliser de cires sur le grès cérame Panaria.

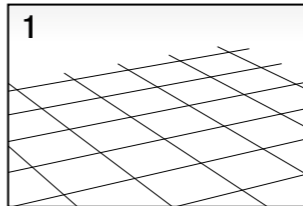

Pavimento originale.
Original floor.
Originalfußboden.
Sol d'origine.

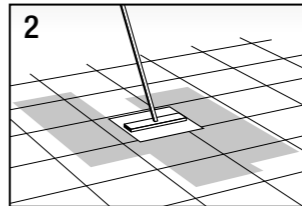

Dopo pulizia con detergenti contenenti cere.
After cleaning with detergents containing wax.
Nach der Reinigung mit wachshaltigen Reinigungsmitteln.
Après un nettoyage avec des détergents contenant de la cire.

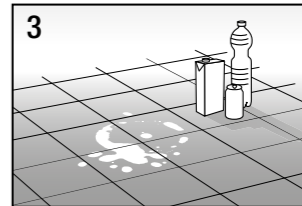

Semplici alimenti (Coca-Cola, vino, acqua..) possono togliere la patina lucida. La superficie originale è più opaca. Simple foodstuffs (Coca-Cola, wine, water etc) can remove the bright patina. The original surface is more matt. Normale Lebensmittel (Coca-Cola, Wein, Wasser usw..) können die glänzende Patina entfernen. Die Originaloberfläche ist matter.

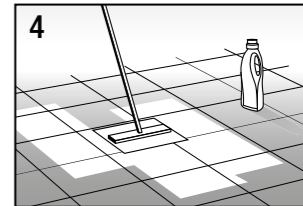

Rimuovere la patina con detergente (pulitore per piastrelle Faber) e utilizzare detergente senza cere per la pulizia quotidiana. Remove the patina with detergent (Faber tile cleaner, non-diluted), and use detergent without wax for everyday cleaning. Die Patina sollte mit Reinigungsmittel entfernt werden (Tile cleaner pur von Faber) und für die tägliche Reinigung sollte ein wachsfreies Reinigungsmittel verwendet werden. Retirer le film à l'aide d'un détergent (Tile Cleaner pur de Faber) et utiliser chaque jour un détergent sans cire.

Indice alfabetico dei prodotti

List of products in alphabetical order_Alphabetisches verzeichnis der Produkte_Index alphabétique des produits

PRODOTTO PRODUCT PRODUKT PRODUIT	TECNOLOGIA TECHNOLOGY TECHNOLOGIE TECHNOLOGIE	SPESSORE THICKNESS STÄRKE ÉPAISSEUR	SERIE SERIES SÉRIE SÉRIE	EFFETTO LOOK OPTIK EFFET	PAGINA PAGE SEITE PAGE
A					
ABISKO naturale	GRES PORCELLANATO A MASSA COLORATA_COLOURED-BODY PORCELAIN STONWARE	9,5/10,5 mm	BOREALIS	legno_wood	257
ABISKO ext		9,5 mm			
ABISKO strutturato		20 mm			
ABYSS naturale	GRES PORCELLANATO LAMINATO_LAMINATED PORCELAIN STONWARE	6 mm	STONE TRACE	pietra_stone	123
ALTA naturale	GRES PORCELLANATO A MASSA COLORATA_COLOURED-BODY PORCELAIN STONWARE	9,5/10,5 mm	BOREALIS	legno_wood	257
ALTA ext		9,5 mm			
ALTA strutturato		20 mm			
ANEMOS naturale	GRES PORCELLANATO A MASSA COLORATA_COLOURED-BODY PORCELAIN STONWARE	9,5 mm	KAIOS	legno_wood	283
ANEMOS ext		9,5 mm			
ANEMOS strutturato		20 mm			
ARABESQUE PEARL lux	GRES PORCELLANATO A MASSA COLORATA_COLOURED-BODY PORCELAIN STONWARE	9,5 mm	ETERNITY	marmo_marble	217
ARABESQUE PEARL soft		9,5 mm			
AUORE naturale	GRES PORCELLANATO A MASSA COLORATA_COLOURED-BODY PORCELAIN STONWARE	9,5 mm	PIERRE DES RÊVES	pietra_stone	89
AUORE ext		9,5 mm			
AUORE strutturato		12/20 mm			
B					
BARGE GIALLA strutturato	GRES PORCELLANATO A MASSA COLORATA_COLOURED-BODY PORCELAIN STONWARE	9/20 mm	BIOARCH	pietra_stone	50
BARGE GRIGIA strutturato	GRES PORCELLANATO LAMINATO_LAMINATED PORCELAIN STONWARE	9/20 mm	MUST	cromatico_chromatic	377
BE BLACK lux		5,5 mm			
BE BLACK soft		5,5 mm			
BE WHITE lux		5,5 mm			
BE WHITE soft		5,5 mm			
BEIGE TENUE naturale	GRES PORCELLANATO LAMINATO_LAMINATED PORCELAIN STONWARE	3,5 mm	EXPERIENCE	cemento_concrete	175
BIANCO DENSO naturale	GRES PORCELLANATO LAMINATO_LAMINATED PORCELAIN STONWARE	3,5 mm	PRIME STONE	pietra_stone	109
BLACK PRIME naturale		5,5 mm			
BLACK PRIME soft	GRES PORCELLANATO A MASSA COLORATA_COLOURED-BODY PORCELAIN STONWARE	9,5 mm	GLAM	cromatico_chromatic	349
BOISERIE BEIGE	GRES PORCELLANATO LAMINATO_LAMINATED PORCELAIN STONWARE	3,5 mm			
BOISERIE MAUVE	GRES PORCELLANATO LAMINATO_LAMINATED PORCELAIN STONWARE	3,5 mm	CROSS WOOD	legno_wood	269
BONE naturale	GRES PORCELLANATO A MASSA COLORATA_COLOURED-BODY PORCELAIN STONWARE	9,5 mm			
BREACH GREY lux	GRES PORCELLANATO A MASSA COLORATA_COLOURED-BODY PORCELAIN STONWARE	9,5 mm	ETERNITY	marmo_marble	217
BREACH GREY soft		9,5 mm			
BUFF naturale	GRES PORCELLANATO A MASSA COLORATA_COLOURED-BODY PORCELAIN STONWARE	9,5 mm	CROSS WOOD	legno_wood	269
BUFF strutturato		20 mm			
C					
CALACATTA WHITE lux	GRES PORCELLANATO LAMINATO_LAMINATED PORCELAIN STONWARE	5,5 mm	TRILOGY	marmo_marble	233
CALACATTA WHITE soft	GRES PORCELLANATO A MASSA COLORATA_COLOURED-BODY PORCELAIN STONWARE	9,5 mm			
	GRES PORCELLANATO LAMINATO_LAMINATED PORCELAIN STONWARE	5,5 mm			
	GRES PORCELLANATO A MASSA COLORATA_COLOURED-BODY PORCELAIN STONWARE	9,5 mm			
CAMMINI naturale	GRES PORCELLANATO A MASSA COLORATA_COLOURED-BODY PORCELAIN STONWARE	9 mm	VIA MAESTRA	pietra_stone	149
CAMMINI strutturato	GRES PORCELLANATO A MASSA COLORATA_COLOURED-BODY PORCELAIN STONWARE	9/20 mm	NUANCE	legno_wood	297
CARAMEL naturale	GRES PORCELLANATO A MASSA COLORATA_COLOURED-BODY PORCELAIN STONWARE	9,5/10,5 mm			
CARAMEL strutturato	GRES PORCELLANATO A MASSA COLORATA_COLOURED-BODY PORCELAIN STONWARE	9,5/20 mm	URBANATURE	cemento_concrete	199
CEMENT naturale	GRES PORCELLANATO LAMINATO_LAMINATED PORCELAIN STONWARE	3,5 mm			
CEMENT strutturato	GRES PORCELLANATO A MASSA COLORATA_COLOURED-BODY PORCELAIN STONWARE	9,5 mm			
CENDRE naturale	GRES PORCELLANATO A MASSA COLORATA_COLOURED-BODY PORCELAIN STONWARE	9,5/10,5 mm	NUANCE	legno_wood	297
CENDRE strutturato		9,5 mm			
CHALET naturale	GRES PORCELLANATO A MASSA COLORATA_COLOURED-BODY PORCELAIN STONWARE	9,5 mm	ASSI D'ALPE	legno_wood	245
CHARME naturale	GRES PORCELLANATO A MASSA COLORATA_COLOURED-BODY PORCELAIN STONWARE	9,5 mm	PIERRE DES RÊVES	pietra_stone	89
CHARME ext		9,5 mm			
CHARME strutturato		20 mm			
CHERRY	RIVESTIMENTO MONOPOROSA IN PASTA BIANCA SMALTATA_GLAZED WHITE BODY POROUS SINGLE-FIRED WALL TILES	8 mm	EVEN	cromatico_chromatic	329
CHROME naturale	GRES PORCELLANATO LAMINATO_LAMINATED PORCELAIN STONWARE	3,5 mm	BLADE	cromatico_chromatic	313
CIASA naturale	GRES PORCELLANATO A MASSA COLORATA_COLOURED-BODY PORCELAIN STONWARE	9,5 mm	ASSI D'ALPE	legno_wood	245
COLORFUL	GRES PORCELLANATO LAMINATO_LAMINATED PORCELAIN STONWARE	3,5 mm	GLAM	cromatico_chromatic	349
CONCRETE naturale	GRES PORCELLANATO LAMINATO_LAMINATED PORCELAIN STONWARE	3,5 mm	URBANATURE	cemento_concrete	199
COPPER naturale	GRES PORCELLANATO A MASSA COLORATA_COLOURED-BODY PORCELAIN STONWARE	9/9,5 mm	MEMORY MOOD	cemento_concrete	186
COTTAGE DARK naturale	GRES PORCELLANATO A MASSA COLORATA_COLOURED-BODY PORCELAIN STONWARE	9 mm	THE PLACE	pietra_stone	135
COTTAGE DARK soft		9 mm			
COTTAGE DARK ext		9 mm			
COTTAGE DARK strutturato		12/20 mm			
COUNTY BEIGE naturale		9 mm			
COUNTY BEIGE soft		9 mm			
COUNTY BEIGE ext		9 mm			
COUNTY BEIGE strutturato		12/20 mm			
CREAMY naturale	GRES PORCELLANATO A MASSA COLORATA_COLOURED-BODY PORCELAIN STONWARE	9/9,5 mm	MEMORY MOOD	cemento_concrete	186
CREEK naturale	GRES PORCELLANATO LAMINATO_LAMINATED PORCELAIN STONWARE	6 mm	STONE TRACE	pietra_stone	123
CREST naturale		6 mm			
D					
DIM naturale	GRES PORCELLANATO A MASSA COLORATA_COLOURED-BODY PORCELAIN STONWARE	9/9,5 mm	MEMORY MOOD	cemento_concrete	186
DISTRICT SMOKE naturale	GRES PORCELLANATO A MASSA COLORATA_COLOURED-BODY PORCELAIN STONWARE	9 mm	THE PLACE	pietra_stone	135
DISTRICT SMOKE soft		9 mm			
DISTRICT SMOKE ext		9 mm			
DISTRICT SMOKE strutturato		20 mm			

PRODOTTO PRODUCT PRODUKT PRODUIT	TECNOLOGIA TECHNOLOGY TECHNOLOGIE TECHNOLOGIE	SPESSORE THICKNESS STÄRKE ÉPAISSEUR	SERIE SERIES SÉRIE SÉRIE	EFFETTO LOOK OPTIK EFFET	PAGINA PAGE SEITE PAGE
DONEGAL naturale	GRES PORCELLANATO A MASSA COLORATA_COLOURED-BODY PORCELAIN STONWARE	9,5/10,5 mm	BOREALIS	legno_wood	257
DONEGAL ext		9,5 mm			
DONEGAL strutturato		20 mm			
DOVE	RIVESTIMENTO MONOPOROSA IN PASTA BIANCA SMALTATA_GLAZED WHITE BODY POROUS SINGLE-FIRED WALL TILES	8 mm	EVEN	cromatico_chromatic	329
DUST naturale	GRES PORCELLANATO A MASSA COLORATA_COLOURED-BODY PORCELAIN STONWARE	9,5 mm	CROSS WOOD	legno_wood	269
DUST strutturato		20 mm			
E					
ESSENCE naturale	GRES PORCELLANATO LAMINATO_LAMINATED PORCELAIN STONWARE	3,5 mm	BLADE	cromatico_chromatic	313
G					
GEM	RIVESTIMENTO MONOPOROSA IN PASTA BIANCA SMALTATA_GLAZED WHITE BODY POROUS SINGLE-FIRED WALL TILES	8 mm	WALLCRAFT	cromatico_chromatic	389
GLADE naturale	GRES PORCELLANATO LAMINATO_LAMINATED PORCELAIN STONWARE	6 mm	STONE TRACE	pietra_stone	123
GLEN naturale	GRES PORCELLANATO A MASSA COLORATA_COLOURED-BODY PORCELAIN STONWARE	9 mm	FRAME	pietra_stone	73
GLEN strutturato		9/20 mm			
GORGE naturale		9 mm			
GORGE strutturato		9/20 mm			
GREENWALL		GRES PORCELLANATO LAMINATO_LAMINATED PORCELAIN STONWARE			
GREIGE PRIME naturale	GRES PORCELLANATO LAMINATO_LAMINATED PORCELAIN STONWARE	5,5 mm	PRIME STONE	pietra_stone	109
GREIGE PRIME soft	GRES PORCELLANATO A MASSA COLORATA_COLOURED-BODY PORCELAIN STONWARE	9,5 mm			
GREIGE PRIME strutturato	GRES PORCELLANATO A MASSA COLORATA_COLOURED-BODY PORCELAIN STONWARE	20 mm			
GRIGIO VIVO naturale	GRES PORCELLANATO LAMINATO_LAMINATED PORCELAIN STONWARE	3,5 mm	EXPERIENCE	cemento_concrete	175
GROOVE naturale	GRES PORCELLANATO A MASSA COLORATA_COLOURED-BODY PORCELAIN STONWARE	9 mm	FRAME	pietra_stone	73
GROOVE strutturato		9/20mm			
H					
HANGAR naturale	GRES PORCELLANATO A MASSA COLORATA_COLOURED-BODY PORCELAIN STONWARE	9,5 mm	CONTEXT	cemento_concrete	167
HANGAR strutturato		9,5/20 mm			
HAZEL naturale	GRES PORCELLANATO A MASSA COLORATA_COLOURED-BODY PORCELAIN STONWARE	9/9,5 mm	MEMORY MOOD	cemento_concrete	186
HEDGE	GRES PORCELLANATO LAMINATO_LAMINATED PORCELAIN STONWARE	3,5 mm	GLAM	cromatico_chromatic	349
HOLLOW naturale	GRES PORCELLANATO LAMINATO_LAMINATED PORCELAIN STONWARE	6 mm	STONE TRACE	pietra_stone	123
I					
ILIOS naturale	GRES PORCELLANATO A MASSA COLORATA_COLOURED-BODY PORCELAIN STONWARE	9,5 mm	KAIOS	legno_wood	283
ILIOS ext		9,5 mm			
ILIOS strutturato		20 mm			
IMERA naturale		9,5 mm			
IMERA ext		9,5 mm			
IMERA strutturato		20 mm			
INARI naturale		9,5/10,5 mm			
INARI ext		9,5 mm			
INARI strutturato	20 mm				
IVORY	RIVESTIMENTO MONOPOROSA IN PASTA BIANCA SMALTATA_GLAZED WHITE BODY POROUS SINGLE-FIRED WALL TILES	8 mm	EVEN	cromatico_chromatic	329
K					
KEEN naturale	GRES PORCELLANATO A MASSA COLORATA_COLOURED-BODY PORCELAIN STONWARE	9/9,5 mm	MEMORY MOOD	cemento_concrete	186
L					
LEAF	RIVESTIMENTO MONOPOROSA IN PASTA BIANCA SMALTATA_GLAZED WHITE BODY POROUS SINGLE-FIRED WALL TILES	8 mm	EVEN	cromatico_chromatic	329
LIME naturale	GRES PORCELLANATO LAMINATO_LAMINATED PORCELAIN STONWARE	3,5 mm	URBANATURE	cemento_concrete	199
LOFT naturale	GRES PORCELLANATO A MASSA COLORATA_COLOURED-BODY PORCELAIN STONWARE	9,5 mm	CONTEXT	cemento_concrete	167
LOFT strutturato		9,5/20 mm			
M					
MANSION naturale	GRES PORCELLANATO A MASSA COLORATA_COLOURED-BODY PORCELAIN STONWARE	9,5 mm	CONTEXT	cemento_concrete	167
MANSION strutturato		9,5/20 mm			
MARQUINA BLACK lux	GRES PORCELLANATO A MASSA COLORATA_COLOURED-BODY PORCELAIN STONWARE	9,5 mm	ETERNITY	marmo_marble	217
MARQUINA BLACK soft		9,5 mm			
MASO naturale	GRES PORCELLANATO A MASSA COLORATA_COLOURED-BODY PORCELAIN STONWARE	9,5 mm	ASSI D'ALPE	legno_wood	245
MIDTOWN WHITE naturale	GRES PORCELLANATO A MASSA COLORATA_COLOURED-BODY PORCELAIN STONWARE	9 mm	THE PLACE	pietra_stone	135
MIDTOWN WHITE soft		9 mm			
MIDTOWN WHITE ext		9 mm			
MIDTOWN WHITE strutturato		20 mm			
MIEL naturale	GRES PORCELLANATO A MASSA COLORATA_COLOURED-BODY PORCELAIN STONWARE	9,5/10,5 mm	NUANCE	legno_wood	297
MIEL strutturato	GRES PORCELLANATO A MASSA COLORATA_COLOURED-BODY PORCELAIN STONWARE	9,5/20 mm			
MINI	RIVESTIMENTO MONOPOROSA IN PASTA BIANCA SMALTATA_GLAZED WHITE BODY POROUS SINGLE-FIRED WALL TILES	8 mm	WALLCRAFT	cromatico_chromatic	389
MISTIC	GRES PORCELLANATO LAMINATO_LAMINATED PORCELAIN STONWARE	3,5 mm	GLAM	cromatico_chromatic	349
MOON BEIGE lux	GRES PORCELLANATO LAMINATO_LAMINATED PORCELAIN STONWARE	5,5 mm	TRILOGY	marmo_marble	233
MOON BEIGE soft	GRES PORCELLANATO A MASSA COLORATA_COLOURED-BODY PORCELAIN STONWARE	9,5 mm			
	GRES PORCELLANATO LAMINATO_LAMINATED PORCELAIN STONWARE	5,5 mm			
MOON BEIGE soft	GRES PORCELLANATO A MASSA COLORATA_COLOURED-BODY PORCELAIN STONWARE	9,5 mm			
N					
NERO PURO naturale	GRES PORCELLANATO LAMINATO_LAMINATED PORCELAIN STONWARE	3,5 mm	EXPERIENCE	cemento_concrete	175
NIAGE naturale	GRES PORCELLANATO A MASSA COLORATA_COLOURED-BODY PORCELAIN STONWARE	9,5 mm	PIERRE DES RÊVES	pietra_stone	89
NIAGE ext		9,5 mm			
NIAGE strutturato		12/20 mm			
O					
OCEAN	RIVESTIMENTO MONOPOROSA IN PASTA BIANCA SMALTATA_GLAZED WHITE BODY POROUS SINGLE-FIRED WALL TILES	8 mm	EVEN	cromatico_chromatic	329
ONYX LIGHT lux	GRES PORCELLANATO LAMINATO_LAMINATED PORCELAIN STONWARE	5,5 mm	TRILOGY	marmo_marble	233
	GRES PORCELLANATO A MASSA COLORATA_COLOURED-BODY PORCELAIN STONWARE	9,5 mm			
	GRES PORCELLANATO LAMINATO_LAMINATED PORCELAIN STONWARE	5,5 mm			
ONYX LIGHT soft	GRES PORCELLANATO A MASSA COLORATA_COLOURED-BODY PORCELAIN STONWARE	9,5 mm			

Indice alfabetico dei prodotti

List of products in alphabetical order_Alphabetisches verzeichnis der Produkte_Index alphabétique des produits

PRODOTTO PRODUCT PRODUKT PRODUIT	TECNOLOGIA TECHNOLOGY TECHNOLOGIE TECHNOLOGIE	SPESSORE THICKNESS STÄRKE ÉPAISSEUR	SERIE SERIES SÉRIE SÉRIE	EFFETTO LOOK OPTIK EFFET	PAGINA PAGE SEITE PAGE
ORIGIN naturale	GRES PORCELLANATO A MASSA COLORATA_COLOURED-BODY PORCELAIN STONEWARE	9,5 mm	DISCOVER	pietra_stone	61
ORIGIN strutturato		9/20 mm			
OUBLI naturale	GRES PORCELLANATO A MASSA COLORATA_COLOURED-BODY PORCELAIN STONEWARE	9,5 mm	PIERRE DES RÊVES	pietra_stone	89
OUBLI ext		9,5 mm			
OUBLI strutturato		12/20 mm			
OXIDE naturale	GRES PORCELLANATO LAMINATO_LAMINATED PORCELAIN STONEWARE	3,5 mm	BLADE	cromatico_chromatic	313
P					
PAESAGGI naturale	GRES PORCELLANATO A MASSA COLORATA_COLOURED-BODY PORCELAIN STONEWARE	9 mm	VIA MAESTRA	pietra_stone	149
PAESAGGI strutturato		9/20 mm			
PATHOS naturale	GRES PORCELLANATO A MASSA COLORATA_COLOURED-BODY PORCELAIN STONEWARE	9,5 mm	KAIROS	legno_wood	283
PATHOS ext		9,5 mm			
PATHOS strutturato		20 mm			
PEAK naturale	GRES PORCELLANATO A MASSA COLORATA_COLOURED-BODY PORCELAIN STONEWARE	9 mm	FRAME	pietra_stone	73
PEAK strutturato		9/20 mm			
PERCORSI naturale	GRES PORCELLANATO A MASSA COLORATA_COLOURED-BODY PORCELAIN STONEWARE	9 mm	VIA MAESTRA	pietra_stone	149
PERCORSI strutturato		9/20 mm			
PERLE naturale	GRES PORCELLANATO A MASSA COLORATA_COLOURED-BODY PORCELAIN STONEWARE	9,5/10,5 mm	NUJANCE	legno_wood	297
PERLE strutturato		9,5 mm			
PORTLAND naturale	GRES PORCELLANATO LAMINATO_LAMINATED PORCELAIN STONEWARE	3,5 mm	BLADE	cromatico_chromatic	313
PORTLAND ext	GRES PORCELLANATO LAMINATO_LAMINATED PORCELAIN STONEWARE	3,5 mm	URBANATURE	cemento_concrete	199
		9,5 mm			
PORTLAND strutturato	GRES PORCELLANATO A MASSA COLORATA_COLOURED-BODY PORCELAIN STONEWARE	20 mm			
R					
RAINFORREST	GRES PORCELLANATO LAMINATO_LAMINATED PORCELAIN STONEWARE	3,5 mm	GLAM	cromatico_chromatic	349
REFLEX		3,5 mm			
RELIC	GRES PORCELLANATO A MASSA COLORATA_COLOURED-BODY PORCELAIN STONEWARE	3,5 mm	PIERRE DES RÊVES	pietra_stone	89
REVELLE naturale		9,5 mm			
REVELLE ext		9,5 mm			
REVELLE strutturato	GRES PORCELLANATO A MASSA COLORATA_COLOURED-BODY PORCELAIN STONEWARE	20 mm			
RIVER naturale	GRES PORCELLANATO A MASSA COLORATA_COLOURED-BODY PORCELAIN STONEWARE	9 mm	FRAME	pietra_stone	73
RIVER strutturato		9/20 mm			
ROSSO MISTO strutturato	GRES PORCELLANATO TUTTA MASSA_FULL-BODY PORCELAIN STONEWARE	9 mm	PIETRE DI FANES	pietra_stone	96
RUST naturale	GRES PORCELLANATO LAMINATO_LAMINATED PORCELAIN STONEWARE	3,5 mm	BLADE	cromatico_chromatic	313
S					
SAND PRIME naturale	GRES PORCELLANATO LAMINATO_LAMINATED PORCELAIN STONEWARE	5,5 mm	PRIME STONE	pietra_stone	109
SAND PRIME soft	GRES PORCELLANATO A MASSA COLORATA_COLOURED-BODY PORCELAIN STONEWARE	9,5 mm			
SAND PRIME strutturato	GRES PORCELLANATO A MASSA COLORATA_COLOURED-BODY PORCELAIN STONEWARE	20 mm			
SANDY GREY lux	GRES PORCELLANATO LAMINATO_LAMINATED PORCELAIN STONEWARE	5,5 mm	TRILOGY	marmo_marble	233
		5,5 mm			
SANDY GREY soft	GRES PORCELLANATO A MASSA COLORATA_COLOURED-BODY PORCELAIN STONEWARE	9,5 mm			
SHAPES	GRES PORCELLANATO LAMINATO_LAMINATED PORCELAIN STONEWARE	3,5 mm	GLAM	cromatico_chromatic	349
SHEER naturale	GRES PORCELLANATO A MASSA COLORATA_COLOURED-BODY PORCELAIN STONEWARE	9/9,5 mm	MEMORY MOOD	cemento_concrete	186
SILICON naturale	GRES PORCELLANATO LAMINATO_LAMINATED PORCELAIN STONEWARE	3,5 mm	URBANATURE	cemento_concrete	199
		9,5 mm			
SILK	RIVESTIMENTO MONOPOROSA IN PASTA BIANCA SMALTATA_GLAZED WHITE BODY POROUS SINGLE-FIRED WALL TILES	8 mm	IONIDA	cromatico_chromatic	365
SILK naturale	GRES PORCELLANATO A MASSA COLORATA_COLOURED-BODY PORCELAIN STONEWARE	8 mm			
SILVER PRIME naturale	GRES PORCELLANATO LAMINATO_LAMINATED PORCELAIN STONEWARE	5,5 mm	PRIME STONE	pietra_stone	109
SILVER PRIME soft	GRES PORCELLANATO A MASSA COLORATA_COLOURED-BODY PORCELAIN STONEWARE	9,5 mm			
SILVER PRIME strutturato		20 mm			
SKIN	RIVESTIMENTO MONOPOROSA IN PASTA BIANCA SMALTATA_GLAZED WHITE BODY POROUS SINGLE-FIRED WALL TILES	8 mm	IONIDA	cromatico_chromatic	365
SKIN naturale	GRES PORCELLANATO A MASSA COLORATA_COLOURED-BODY PORCELAIN STONEWARE	8 mm			
SNOW	RIVESTIMENTO MONOPOROSA IN PASTA BIANCA SMALTATA_GLAZED WHITE BODY POROUS SINGLE-FIRED WALL TILES	8 mm	EVEN	cromatico_chromatic	329
SPRING	RIVESTIMENTO MONOPOROSA IN PASTA BIANCA SMALTATA_GLAZED WHITE BODY POROUS SINGLE-FIRED WALL TILES	8 mm	WALLCRAFT	cromatico_chromatic	389
SQUARE naturale	GRES PORCELLANATO A MASSA COLORATA_COLOURED-BODY PORCELAIN STONEWARE	9,5 mm	CONTEXT	cemento_concrete	167
SQUARE strutturato		9,5/20 mm			
STAR WHITE smooth	GRES PORCELLANATO LAMINATO_LAMINATED PORCELAIN STONEWARE	3,5 mm	MUST	cromatico_chromatic	377
STATUARIO WHITE lux	GRES PORCELLANATO A MASSA COLORATA_COLOURED-BODY PORCELAIN STONEWARE	9,5 mm	ETERNITY	marmo_marble	217
STATUARIO WHITE soft		9,5 mm			
STIGMI naturale	GRES PORCELLANATO A MASSA COLORATA_COLOURED-BODY PORCELAIN STONEWARE	9,5 mm	KAIROS	legno_wood	283
STIGMI ext		9,5 mm			
STIGMI strutturato		20 mm			
STORE naturale	GRES PORCELLANATO A MASSA COLORATA_COLOURED-BODY PORCELAIN STONEWARE	9,5 mm	CONTEXT	cemento_concrete	167
STORE strutturato		9,5/20 mm			
SUBURB GREY naturale	GRES PORCELLANATO A MASSA COLORATA_COLOURED-BODY PORCELAIN STONEWARE	9 mm	THE PLACE	pietra_stone	135
SUBURB GREY soft		9 mm			
SUBURB GREY ext		9 mm			
SUBURB GREY strutturato		12/20 mm			
SUN naturale	GRES PORCELLANATO A MASSA COLORATA_COLOURED-BODY PORCELAIN STONEWARE	9,5 mm	DISCOVER	pietra_stone	61
SUN strutturato		9/20 mm			
T					
TABAC naturale	GRES PORCELLANATO A MASSA COLORATA_COLOURED-BODY PORCELAIN STONEWARE	9,5/10,5 mm	NUJANCE	legno_wood	297
TABAC strutturato		9,5/20 mm			
TAN	RIVESTIMENTO MONOPOROSA IN PASTA BIANCA SMALTATA_GLAZED WHITE BODY POROUS SINGLE-FIRED WALL TILES	8 mm	WALLCRAFT	cromatico_chromatic	389
TARTAN BEIGE	GRES PORCELLANATO LAMINATO_LAMINATED PORCELAIN STONEWARE	3,5 mm	GLAM	cromatico_chromatic	349
TARTAN MAUVE		3,5 mm			

PRODOTTO PRODUCT PRODUKT PRODUIT	TECNOLOGIA TECHNOLOGY TECHNOLOGIE TECHNOLOGIE	SPESSORE THICKNESS STÄRKE ÉPAISSEUR	SERIE SERIES SÉRIE SÉRIE	EFFETTO LOOK OPTIK EFFET	PAGINA PAGE SEITE PAGE
TOUCH	RIVESTIMENTO MONOPOROSA IN PASTA BIANCA SMALTATA_GLAZED WHITE BODY POROUS SINGLE-FIRED WALL TILES	8 mm	IONIDA	cromatico_chromatic	365
TOUCH naturale	GRES PORCELLANATO A MASSA COLORATA_COLOURED-BODY PORCELAIN STONEWARE	8 mm			
TRAGITTI naturale	GRES PORCELLANATO A MASSA COLORATA_COLOURED-BODY PORCELAIN STONEWARE	9 mm	VIA MAESTRA	pietra_stone	149
TRAGITTI strutturato		9/20 mm			
V					
VANILLA	RIVESTIMENTO MONOPOROSA IN PASTA BIANCA SMALTATA_GLAZED WHITE BODY POROUS SINGLE-FIRED WALL TILES	8 mm	WALLCRAFT	cromatico_chromatic	389
VELVET	RIVESTIMENTO MONOPOROSA IN PASTA BIANCA SMALTATA_GLAZED WHITE BODY POROUS SINGLE-FIRED WALL TILES	8 mm	IONIDA	cromatico_chromatic	365
VELVET naturale	GRES PORCELLANATO A MASSA COLORATA_COLOURED-BODY PORCELAIN STONEWARE	8 mm			
VIBES	GRES PORCELLANATO LAMINATO_LAMINATED PORCELAIN STONEWARE	3,5 mm	GLAM	cromatico_chromatic	349
W					
WASHI	GRES PORCELLANATO LAMINATO_LAMINATED PORCELAIN STONEWARE	3,5 mm	GLAM	cromatico_chromatic	349
WAVE	RIVESTIMENTO MONOPOROSA IN PASTA BIANCA SMALTATA_GLAZED WHITE BODY POROUS SINGLE-FIRED WALL TILES	8 mm	WALLCRAFT	cromatico_chromatic	389
WAX		8 mm			
WHITE naturale	GRES PORCELLANATO A MASSA COLORATA_COLOURED-BODY PORCELAIN STONEWARE	9,5 mm	DISCOVER	pietra_stone	61
WHITE strutturato		9/20 mm			
WHITE PRIME naturale	GRES PORCELLANATO LAMINATO_LAMINATED PORCELAIN STONEWARE	5,5 mm	PRIME STONE	pietra_stone	109
WHITE PRIME soft	GRES PORCELLANATO A MASSA COLORATA_COLOURED-BODY PORCELAIN STONEWARE	9,5 mm			
Z					
ZOI naturale	GRES PORCELLANATO A MASSA COLORATA_COLOURED-BODY PORCELAIN STONEWARE	9,5 mm	KAIROS	legno_wood	283
ZOI ext		9,5 mm			
ZOI strutturato		20 mm			

Condizioni generali di vendita

General terms and conditions of sale_Allgemeine Verkaufsbedingungen_Conditions générales de vente

1) Ambito di applicazione

1.1 Le presenti condizioni generali di vendita ("CGV") si applicheranno a tutte le forniture di piastrelle in ceramica o altri prodotti in ceramica ("Prodotti") che saranno eseguite nei confronti di qualsiasi cliente ("CLIENTE") da una società o divisione del Gruppo Panariagroup Industrie Ceramiche S.p.A. ("VENDITORE") anche se le CGV non verranno di volta in volta espressamente richiamate, menzionate ovvero espressamente accettate dal CLIENTE.

1.2 Accordi in deroga alle presenti CGV saranno efficaci nei confronti di VENDITORE soltanto (i) se contenuti nel "Contratto di Vendita", come definito al successivo paragrafo 3.2, (ii) se contenuti in documenti successivi alla conclusione del Contratto di Vendita ed il cui contenuto sia stato accettato per iscritto da VENDITORE. In ogni caso, anche se presenti deroghe concordate per iscritto, le CGV continueranno ad applicarsi per le parti non espressamente derogate.

1.3 In nessun caso VENDITORE sarà vincolato da eventuali condizioni generali di contratto di CLIENTE, neanche qualora esse siano richiamate o riportate negli ordini o in qualsiasi altra documentazione trasmessa a VENDITORE da CLIENTE. Nessun comportamento di VENDITORE potrà essere interpretato o utilizzato al fine di esprimere tacita accettazione di VENDITORE delle condizioni generali di contratto di CLIENTE.

1.4 In nessun caso, VENDITORE sarà vincolato da atti e/o azioni dei propri agenti, essendo questi ultimi privi del potere di vincolare il VENDITORE.

1.5 Nel caso in cui CLIENTE sia un consumatore, le disposizioni delle presenti CGV non pregiudicheranno i diritti allo stesso spettanti in base alle previsioni di legge relative alle vendite eseguite nei confronti dei consumatori.

2) Prodotti – Modifiche

2.1 Le rappresentazioni e/o immagini riguardanti i Prodotti riportate in siti internet, brochure, cataloghi, listini prezzi o documenti simili di VENDITORE hanno valore indicativo ed illustrativo. Allo stesso modo i campioni e modelli rappresentano solo indicativamente per peso, dimensione, capacità, rendimento, colore le caratteristiche dei Prodotti ed hanno solo carattere di indicazioni approssimative e/o di massima e non hanno valore impegnativo per VENDITORE se non nella misura in cui siano espressamente menzionati come tali nell'accettazione scritta dell'offerta da parte di VENDITORE non rappresentando il risultato estetico finale dei Prodotti. Le caratteristiche tecniche e fisiche nonché le qualità dei Prodotti sono riportate unicamente nei manuali tecnici di VENDITORE. Ogni altro documento riportante le caratteristiche tecniche e fisiche nonché le qualità dei Prodotti ha valore puramente indicativo e non sarà vincolante per VENDITORE.

2.2 VENDITORE dichiara che i Prodotti sono conformi alle norme italiane e comunitarie di settore ad essi applicabili. A pena di inefficacia della garanzia di cui all'articolo 7 e di qualsiasi altra garanzia convenzionale e/o legale, ciascun Prodotto dovrà essere utilizzato ed applicato in conformità alle indicazioni di utilizzo di VENDITORE riferite ai Prodotti in questione e riportate nei cataloghi e/o nei manuali tecnici di VENDITORE ovvero diversamente comunicate o rese accessibili da VENDITORE a CLIENTE e, comunque, in conformità alla diligenza richiesta dalla natura dei Prodotti stessi.

2.3 È responsabilità di CLIENTE, prima della conclusione del Contratto di Vendita, accertare che i Prodotti siano idonei allo scopo e/o all'uso specifico per il quale intende acquistarli e, inoltre, accertare che i Prodotti medesimi siano conformi alla normativa applicabile nel luogo in cui CLIENTE intende importarli, distribuirli, venderli o farne qualsiasi uso.

2.4 VENDITORE, anche dopo la conclusione del Contratto di Vendita, potrà apportare ai Prodotti qualsiasi modifica che esso ritenga necessaria o opportuna, purché non ne alteri le caratteristiche essenziali. Qualora VENDITORE esegua modifiche sostanziali ai Prodotti (ad es. modifiche che interessano: le modalità di installazione, le caratteristiche di intercambiabilità dei Prodotti ecc.) oggetto di un Contratto di Vendita (come definito al successivo paragrafo 3.2), VENDITORE comunicherà per iscritto tale modifica a CLIENTE.

2.5 CLIENTE sarà tenuto a rappresentare agli acquirenti dei Prodotti e ai terzi le caratteristiche dei Prodotti nonché le indicazioni d'uso e di applicazione degli stessi, in conformità a quanto rappresentatogli da VENDITORE. Fermo restando quanto sopra, CLIENTE sarà esclusivamente responsabile per le dichiarazioni effettuate nei confronti dei terzi in relazione ai Prodotti, alle loro caratteristiche e al loro uso e/o applicazione e dovrà tenere VENDITORE indenne e manlevato da qualsiasi danno eventualmente subito da VENDITORE in relazione a o in connessione con tali dichiarazioni di CLIENTE, nel caso in cui le stesse siano false, incomplete e/o inesatte.

3) Preventivi – Conclusione del Contratto di Vendita - Tolleranze

3.1 I preventivi, verbali o scritti, di VENDITORE non costituiscono proposte contrattuali.

3.2 Il contratto di vendita ("Contratto di Vendita") si perfezionerà attraverso:

a) la trasmissione della offerta da parte di VENDITORE e l'accettazione scritta di tale offerta da parte di CLIENTE senza alcuna modifica all'offerta stessa; oppure
b) la trasmissione dell'ordine da parte di CLIENTE e l'accettazione scritta di tale ordine da parte di VENDITORE.

3.3 Ai fini del precedente paragrafo 3.2, lettera a) i seguenti fatti o atti avranno valore di accettazione scritta della offerta di VENDITORE da parte di CLIENTE:

a) ricezione e accettazione, da parte di VENDITORE, di una lettera di credito procurata da CLIENTE;
b) ricezione e accettazione, da parte di VENDITORE, di tutto o di parte del prezzo della fornitura;

c) ricezione, da parte di VENDITORE, di un ordine di acquisto emesso da CLIENTE. In tal caso, qualsiasi previsione dell'ordine di acquisto di CLIENTE che risulti difforme dalle previsioni della offerta di VENDITORE sarà vincolante nei confronti di VENDITORE solo se specificamente accettata per iscritto da quest'ultimo.

3.4 Inoltre, ai fini del precedente paragrafo 3.2, lettera b), nel caso in cui la accettazione di VENDITORE dell'ordine di CLIENTE contenga condizioni differenti rispetto all'ordine formulato da CLIENTE, il Contratto di Vendita si considererà concluso alle condizioni riportate nella conferma d'ordine di VENDITORE, salvo il caso in cui CLIENTE comunichi per iscritto di rifiutare le modifiche riportate nella accettazione dell'ordine di VENDITORE entro 1 (uno) giorno lavorativo dalla ricezione della stessa.

3.5 Le forniture comprenderanno esclusivamente quanto indicato nel Contratto di

Vendita.

3.6 CLIENTE riconosce a VENDITORE i margini di tolleranza quantitativa e/o qualitativa rinvenibili dal Contratto di Vendita o dagli usi o dalla prassi del settore dei Prodotti.

4) Imballaggio - Termini di resa - Termini di consegna

4.1 I Prodotti saranno imballati ed approntati per la spedizione secondo i sistemi di protezione generalmente adottati da VENDITORE per i Prodotti in questione in considerazione delle modalità di trasporto convenute. Qualora CLIENTE ritenga necessario l'impiego di imballaggi speciali o di protezioni aggiuntive dovrà farne espresa richiesta a VENDITORE, fermo restando che, in tal caso, saranno a carico di CLIENTE tutti i relativi costi.

4.2 Salvo diversamente previsto nel Contratto di Vendita, i Prodotti saranno consegnati a CLIENTE in conformità alla regola Incoterms® ICC, ultima versione, Ex-Works (EXW) – stabilimento di VENDITORE indicato nel Contratto di Vendita. CLIENTE autorizza VENDITORE a sottoscrivere, in nome e per conto di CLIENTE, tutti i documenti che debbano essere sottoscritti al momento della presa in carico dei Prodotti presso gli stabilimenti di VENDITORE, come, ad esempio, il CMR. Nel caso in cui la regola Incoterms® ICC concordata tra le parti preveda che CLIENTE debba curare il trasporto dei Prodotti fuori dall'Italia:

a) in caso di cessione intra-comunitaria, entro 45 (quarantacinque) giorni dalla ricezione dei Prodotti presso gli stabilimenti di CLIENTE, CLIENTE dovrà trasmettere a VENDITORE un originale o una copia del documento di trasporto internazionale CMR o di altro documento di trasporto, sottoscritti a destinazione da CLIENTE ovvero, in assenza del CMR, una dichiarazione di ricezione dei Prodotti, emessa sulla base del form quale Allegato -1- disponibile per il download all'indirizzo www.panariagroup.it;

b) in caso di cessione extra-comunitaria, CLIENTE si impegna a:
i) presentare la dichiarazione doganale di esportazione (DAU-EX e DAE) ed effettuare l'appuntamento del MRN (Movement Reference Number) presso la dogana del territorio comunitario di uscita dei Prodotti, entro 90 (novanta) giorni dalla data di consegna in Italia dei Prodotti stessi;

ii) inviare a VENDITORE, entro 90 (novanta) giorni dalla data di consegna, i documenti comprovanti l'esportazione dei Prodotti (dichiarazione di esportazione DAU-EX + DAE + notifica di avvenuta esportazione);
iii) confermare prontamente per iscritto a VENDITORE l'avvenuta esecuzione delle suddette formalità e a fornirgli ogni ulteriore documento comprovante l'esecuzione delle suddette formalità e l'uscita dei Prodotti dal territorio dell'Unione Europea. In caso di inadempienza di CLIENTE a quanto pattuito al presente paragrafo 4.2, VENDITORE avrà il diritto di addebitare immediatamente a CLIENTE l'imposta sul Valore Aggiunto relativa alla fornitura e connessa alla mancata prova del trasporto dei Prodotti in altro Stato Membro della Comunità Europea o mancato appuramento della esportazione. In ogni caso, CLIENTE terrà indenne e manlevato VENDITORE in relazione al pagamento di tutto quanto eventualmente dovuto da VENDITORE nei confronti dell'Amministrazione Finanziaria, a titolo di sanzioni ed interessi o ad altro titolo, in connessione con la fornitura e la mancata prova del trasporto dei Prodotti in altro Stato Membro della Comunità Europea o al mancato appuramento della esportazione.

A tal proposito, VENDITORE potrà: (i) compensare qualsiasi importo dovuto da CLIENTE in base al presente paragrafo 4.2 con eventuali crediti maturati da CLIENTE, a qualsiasi titolo, nei confronti di VENDITORE; ovvero (ii) trattenere definitivamente eventuali somme già ricevute da CLIENTE in relazione a Contratti di Vendita ancora da eseguirsi, effettuando una compensazione fra il debito di CLIENTE in base al presente paragrafo 4.2 e tutti i pagamenti già eseguiti da CLIENTE.

4.3 VENDITORE eseguirà la consegna dei Prodotti entro il termine previsto nel Contratto di Vendita, anche mediante consegne parziali. Il termine di consegna si intenderà in ogni caso non essenziale né perentorio. Salvo il caso di dolo o colpa grave, VENDITORE non sarà tenuto a corrispondere a CLIENTE alcun indennizzo o risarcimento per eventuali danni diretti o indiretti dovuti al ritardo nella consegna. In nessun caso di ritardo nella consegna dei Prodotti CLIENTE avrà il diritto di risolvere il Contratto di Vendita.

4.4 Al momento della ricezione dei Prodotti, CLIENTE avrà l'onere di denunciare danneggiamenti agli imballi e/o eventuali avarie o ammanchi di Prodotti verificatisi durante il trasporto, mediante apposizione di riserva scritta nel documento di trasporto, nonché l'onere di:

a) far confermare dal vettore, mediate apposita sottoscrizione, l'apposizione della riserva; e
b) informare immediatamente per iscritto VENDITORE e inviargli copia del suddetto documento entro e non oltre 8 (otto) giorni dalla data di ricezione dei Prodotti. In caso contrario, VENDITORE non sarà responsabile per eventuali danneggiamenti, perdite o furti occorsi ai Prodotti durante il trasporto, anche qualora lo stesso sia eseguito con rischio in tutto o in parte a carico di VENDITORE.

5) Prezzi – Pagamento – Ritardato pagamento

5.1 I Prodotti verranno forniti ai prezzi concordati tra le parti nel Contratto di Vendita o, qualora il Contratto di Vendita non dovesse menzionare alcun prezzo, ai prezzi riportati nel listino prezzi di VENDITORE in vigore al momento della conclusione del Contratto di Vendita. Salvo diversa indicazione scritta, i prezzi dei Prodotti riportati nei listini, nei preventivi e/o nelle offerte di VENDITORE si intendono in Euro, al netto di IVA e per consegne eseguite in conformità alla regola Incoterms® Ex-Works (EXW), stabilimento di VENDITORE indicato nel Contratto di Vendita, ICC, ultima versione. Pertanto, nel caso in cui venga convenuto un diverso termine di resa, l'importo della fattura verrà modificato di conseguenza, includendo in fattura le spese di trasporto e ogni altro onere connesso con il termine di resa concordato tra le parti per la consegna dei Prodotti.

5.2 Il pagamento dei Prodotti dovrà essere eseguito da CLIENTE con le modalità e nei tempi indicati nel Contratto di Vendita o diversamente concordati per iscritto tra le parti. I pagamenti si considereranno effettuati da CLIENTE solo nel momento in cui il relativo importo sarà stato accreditato sul conto corrente di VENDITORE. Il pagamento dovrà essere effettuato da CLIENTE in Euro ovvero nella valuta del luogo in cui CLIENTE ha la propria sede, a scelta di VENDITORE, in conformità alla valuta che VENDITORE indicherà nella relativa fattura di vendita.

5.3 Nel caso in cui CLIENTE sia in ritardo nell'esecuzione del pagamento, VENDITORE avrà diritto:

a) al pagamento degli interessi legali di mora, in conformità alla legge applicabile;
b) di sospendere le consegne ancora da eseguirsi, previa comunicazione scritta a CLIENTE, fino a quando gli importi dovuti e i relativi interessi di mora siano stati integralmente pagati.

5.4 Qualora tali importi e interessi risultino ancora non pagati una volta decorsi 30 (trenta) giorni dalla scadenza data di pagamento concordata, VENDITORE potrà altresì, a propria discrezione, alternativamente o cumulativamente, e in aggiunta a qualsiasi altro diritto o rimedio allo stesso spettante in base alla legge o alle presenti CGV:

a) esigere l'immediato pagamento di ogni debito residuo, anche se sia stato convenuto un pagamento a rate o un pagamento dilazionato e/o siano stati emessi e siano in scadenza cambiali tratte, pagherò cambiari, assegni o altri strumenti di pagamento;
b) risolvere il Contratto di Vendita in questione e trattenere definitivamente eventuali somme già ricevute in relazione a tale Contratto di Vendita e/o ad altri Contratti di Vendita, effettuando una compensazione fra il debito di CLIENTE e tutti i pagamenti ricevuti;

c) eseguire le future consegne dei Prodotti soltanto previo pagamento anticipato in relazione alle forniture ancora da eseguirsi;
d) revocare sconti e bonus che siano stati concordati fra le parti anche in relazione a Contratti di Vendita regolarmente eseguiti.

5.5 I diritti di cui ai precedenti paragrafi 5.3 e 5.4 potranno essere esercitati in qualsiasi momento da VENDITORE anche nel caso in cui:

a) CLIENTE sia sottoposto a liquidazione, a procedure concorsuali, fallimentari, di ristrutturazione del debito o ad azioni esecutive; oppure
b) la compagnia assicurativa di VENDITORE rifiuti la copertura assicurativa di crediti di VENDITORE nei confronti di CLIENTE; oppure
c) CLIENTE versi in uno stato di difficoltà finanziaria - idoneo a determinare un pregiudizio al puntuale adempimento dei propri obblighi di pagamento - risultante, a titolo esemplificativo e non esaustivo, dalla levata di protesti, dalla diminuzione di garanzie concesse e/o dalla mancata prestazione di garanzie promesse, nonché dal verificarsi di qualsiasi insoluto, anche qualora tali circostanze si siano verificate nell'ambito dei rapporti tra CLIENTE ed altri suoi fornitori.

5.6 CLIENTE non potrà far valere eventuali inadempimenti di VENDITORE né potrà avviare alcuna azione legale nei confronti dello stesso fino a quando non abbia pagato integralmente a VENDITORE ogni importo allo stesso spettante ai sensi dei paragrafi 5.3 e 5.4.

6) Riserva di Proprietà

6.1 VENDITORE manterrà la proprietà dei Prodotti venduti fino al completo pagamento del loro prezzo da parte di CLIENTE.

Fermo restando quanto sopra, il rischio di perimento dei Prodotti sarà disciplinato dal termine di resa Incoterms® concordato tra le parti per la consegna dei Prodotti.

6.2 In caso di inadempimento o ritardo nell'adempimento dell'obbligo di pagare il prezzo dei Prodotti, fermo restando quanto previsto ai precedenti paragrafi 5.4, 5.5 e 5.6, VENDITORE avrà il diritto di accedere ai locali in cui si trovano i Prodotti, di rientrarne in possesso e di incamerare definitivamente, a titolo di penale, eventuali somme pagate da CLIENTE per i Prodotti in questione.

7) Garanzia

7.1 Fatto salvo quanto previsto ai precedenti paragrafi 2.1, 2.2, 2.4 e 3.6 in relazione alle modifiche ammesse ai Prodotti e alle tolleranze, VENDITORE garantisce a CLIENTE che i Prodotti saranno conformi al Contratto di Vendita, alla classificazione indicata nei manuali tecnici, cataloghi e/o listini prezzi di VENDITORE nonché privi di difetti di fabbricazione. La presente garanzia avrà la durata di 12 (dodici) mesi dalla data di ritiro dei Prodotti dallo stabilimento di VENDITORE, a prescindere dal termine di resa Incoterms® concordato.

7.2 Sono esclusi da qualsiasi garanzia:

a) le alterazioni cromatiche e le differenze di tonalità dei Prodotti;
b) i Prodotti classificati nel Contratto di Vendita come di qualità inferiore alla prima scelta ovvero come partite di Prodotti di fine serie venduta in blocco ovvero come partite speciali;
c) i Prodotti non posati a regola d'arte e/o posati in modo difforme rispetto alle previsioni delle norme di settore applicabili;
d) i Prodotti applicati su superfici e/o in ambienti diversi da quelli consigliati da VENDITORE;

e) i Prodotti utilizzati in modo difforme rispetto alle istruzioni e/o indicazioni di VENDITORE incluse nei cataloghi e/o i listini di VENDITORE ovvero in altro modo comunicate a CLIENTE da VENDITORE ivi incluse le indicazioni di cui al precedente paragrafo 2.2;

f) i Prodotti utilizzati in modo non conforme alla normale diligenza e/o alla tecnica richieste dalla natura dei Prodotti stessi;

g) l'ingelività del Prodotto, a meno che tale caratteristica del Prodotto non sia stata dichiarata da VENDITORE nel manuale tecnico, in riferimento al Prodotto in questione;

h) caratteristiche dei Prodotti come risultanti dalla classificazione del materiale ceramico (i) eseguita da parte di organismi di controllo e/o certificazione diversi da quelli di Paesi dell'Unione Europea e/o (ii) effettuata sulla base di criteri che non corrispondano a quelli utilizzati da VENDITORE.

7.3 Fermo quanto previsto al precedente paragrafo 4.4, CLIENTE sarà tenuto ad esaminare i Prodotti nel più breve tempo possibile e, a pena di decadenza dalla presente garanzia, a denunciare per iscritto a VENDITORE, a mezzo fax o email:

a) difformità relative alla tipologia e/o alla quantità dei Prodotti ricevuti nonché altre difformità palesi dei Prodotti o loro difetti palesi: entro e non oltre 8 (otto) giorni dalla consegna dei Prodotti e, comunque, prima della posa in opera dei Prodotti;
b) difformità occulte o difetti occulti dei Prodotti: entro e non oltre 8 (otto) giorni dalla scoperta e, comunque, entro il periodo di garanzia.

7.4 VENDITORE avrà il diritto di verificare i Prodotti, o alcuni campioni dei Prodotti, che CLIENTE ritenga essere difformi o difettosi, anche al fine di verificare il rispetto delle prescrizioni relative alla posa in opera degli stessi e/o all'applicazione e/o all'utilizzo dei Prodotti come rinvenibili dalle presenti CGV. A tale proposito, CLIENTE potrà restituire a VENDITORE i Prodotti dallo stesso ritenuti difformi o difettosi soltanto previa autorizzazione scritta di VENDITORE ed a condizione che CLIENTE si faccia integralmente carico delle spese e dei rischi di spedizione. L'autorizzazione

al reso dei Prodotti o dei campioni asseritamente difformi o difettosi non costituirà in nessun caso riconoscimento delle difformità o dei difetti da parte di VENDITORE.

7.5 Nel caso in cui i Prodotti siano riconosciuti da VENDITORE come effettivamente difformi o difettosi, CLIENTE, a scelta di VENDITORE, avrà esclusivamente diritto:

a) alla sostituzione gratuita dei Prodotti difformi o difettosi; oppure
b) all'esonero parziale o totale dal pagamento del loro prezzo, a seconda della gravità delle difformità o dei difetti.

7.6 Ai fini del paragrafo 7.5 lettera (a), i Prodotti che debbano essere consegnati in sostituzione di Prodotti difformi o difettosi saranno consegnati a CLIENTE in conformità alla regola Incoterms® 2010 ICC DDP – stabilimento di CLIENTE. I Prodotti che siano stati sostituiti dovranno essere, a scelta di VENDITORE, distrutti o smaltiti da CLIENTE, a spese di quest'ultimo, ovvero restituiti a VENDITORE, a spese di VENDITORE stesso. Per i Prodotti sostituiti che debbano essere distrutti o smaltiti da CLIENTE, CLIENTE si impegna ad inviare a VENDITORE la prova dell'avvenuta distruzione o smaltimento dei Prodotti, unitamente ai documenti giustificativi comprovanti il sostenimento dei costi di distruzione o smaltimento.

7.7 I diritti e rimedi descritti ai precedenti paragrafi 7.5 e 7.6 costituiscono i soli diritti e rimedi in garanzia concessi a CLIENTE. Nella massima misura consentita dalla legge, sono esclusi ulteriori responsabilità o obblighi di VENDITORE in relazione alla fornitura di Prodotti difformi o difettosi, ivi inclusi, a titolo esemplificativo e non esaustivo, responsabilità e obblighi per eventuali danni diretti, indiretti o consequenziali, perdite di profitto, ecc. a cui tale responsabilità si ricollega.

7.8 La presente garanzia sostituisce ed esclude ogni altra garanzia, espressa o implicita, prevista per legge o altrimenti.

8) Forza maggiore

8.1 VENDITORE non sarà in alcun modo responsabile per il mancato o ritardato adempimento di alcuna obbligazione relativa alla fornitura dei Prodotti qualora tale mancato o ritardato adempimento sia dovuto a eventi di forza maggiore come guerre, incendi, terremoti, inondazioni, tsunami, scioperi, difficoltà insorte con la forza lavoro, scarsità o difficoltà di approvvigionamento di materie prime, restrizioni all'uso di energia, sospensione o difficoltà nei trasporti, guasti agli impianti, atti della pubblica autorità o a qualsiasi altra azione o causa che non possa essere ragionevolmente prevista o alla quale VENDITORE non possa ragionevolmente porre rimedio tramite l'ordinaria diligenza.

8.2 In tali eventualità, il termine per l'esecuzione della fornitura verrà esteso per tutto il periodo di durata dell'evento di forza maggiore, fermo restando che, qualora tale evento dovesse impedire l'esecuzione della fornitura per oltre 6 (sei) mesi, CLIENTE avrà il diritto di risolvere il relativo contratto di vendita, mediante invio di lettera raccomandata con ricevuta di ritorno o corriere a VENDITORE, senza alcuna responsabilità o conseguenza per VENDITORE.

9) Invalidità di singole clausole contrattuali

L'invalidità di una disposizione delle presenti CGV non comprometterà la validità delle residue disposizioni che rimarranno pienamente valide e efficaci.

10) Riservatezza

10.1 CLIENTE si impegna a: (i) trattare come riservati tutte le informazioni/dati/disegni/know-how/documentazione trasmessigli da VENDITORE ovvero di cui sia venuto a conoscenza nell'esecuzione dei singoli Contratti di Vendita, indipendentemente dal fatto che tali informazioni siano o meno contrassegnate o identificate come riservate o confidenziali ("Informazioni "Riservate"); (ii) non divulgare e non comunicare a terzi, né in tutto né in parte, le Informazioni Riservate senza il preventivo consenso scritto di VENDITORE; (iii) limitare l'utilizzo di tali Informazioni Riservate ed il relativo accesso per scopi relativi all'esecuzione dei singoli Contratti di Vendita; (iv) adattare tutte le misure necessarie al fine di assicurare che i propri dipendenti e i propri collaboratori evitino di divulgare a terzi le Informazioni Riservate o le utilizzino in modo improprio. Le Informazioni Riservate non potranno essere riprodotte senza previo consenso scritto di VENDITORE, e tutte le copie delle stesse saranno immediatamente restituite dietro richiesta di VENDITORE.

10.2 Le previsioni di cui sopra non si applicano alle informazioni che: (i) sono pubbliche o divengono pubbliche non per divulgazione da parte del CLIENTE, dei suoi dipendenti o collaboratori, o (ii) erano in possesso del CLIENTE prima che le ricevesse da VENDITORE o (iii) sono state divulgate da fonti che non sono sottoposte alle restrizioni cui è sottoposto CLIENTE relativamente al loro utilizzo, o (iv) possono essere divulgate a terzi in base ad un'autorizzazione scritta di VENDITORE.

11) Legge applicabile - Risoluzione delle controversie

11.1 Le presenti CGV e tutti i Contratti di Vendita che le parti stipuleranno in base alle presenti CGV saranno regolati dalla Convenzione di Vienna del 1980 sulla vendita internazionale di merci e, nelle materie non coperte da tale Convenzione, dalla legge italiana.

11.2 Qualsiasi controversia relativa alle presenti CGV e/o ai Contratti di Vendita che interverranno sulla base delle stesse sarà decisa in conformità alle seguenti previsioni:

a) qualora CLIENTE abbia la sua sede legale nell'Unione Europea, in Svizzera, in Norvegia o in Islanda, la controversia sarà assoggettata in via esclusiva alla giurisdizione italiana e, in relazione ad essa, sarà esclusivamente competente il Tribunale di Modena (Italia);

b) in tutti gli altri casi, la controversia sarà decisa in via esclusiva e definitiva mediante arbitro, celebrato da un arbitro unico, in conformità al Regolamento di Procedura della Camera Arbitrale di Milano.

L'arbitrato avrà sede, e il lodo arbitrale verrà pronunciato, nella città di Milano (Italia). La lingua dell'arbitrato sarà la lingua inglese.

11.3 È tuttavia concesso, unicamente a favore di VENDITORE, il diritto incondizionato di agire, in qualità di attore, sotto la giurisdizione di CLIENTE innanzi al tribunale competente.

12) Lingua delle CGV

12.1 Il testo delle presenti CGV è redatto sia in lingua italiana che in lingua inglese. In caso di discrepanza, il testo in lingua italiana prevarrà sul testo in lingua inglese.

Le presenti condizioni generali di vendita sono pubblicate e scaricabili sul sito internet www.panariagroup.it

Condizioni generali di vendita

General terms and conditions of sale_Allgemeine Verkaufsbedingungen_Conditions générales de vente

1) Scope Of Application

1.1 These General Terms and Conditions of Sale ("General Conditions") shall apply to any and all supply of ceramic tiles or other ceramic products ("Products") that will be executed to any client ("CLIENT") from any company or division of the Group Panariagroup Industrie Ceramiche S.p.A. ("SELLER"), even if these General Conditions are not expressly referred to, mentioned or expressly accepted by the CLIENT from time to time.

1.2 No provisions deviating from these General Conditions shall be binding on SELLER unless (i) included in the "Sale Contract", as defined under paragraph 3.2 below, (ii) included in documents following the Sale Contract and the content of the same has been accepted in writing by SELLER. In any case, even if deviating provisions are agreed upon, these General Conditions shall apply for the parts not expressly disregarded.

1.3 In no case shall any general conditions of contract of CLIENT be binding on SELLER, even if mentioned or included in orders or in any other documents transmitted by CLIENT to SELLER. No conduct of SELLER shall be interpreted or used in order to express tacit acceptance of SELLER to the general conditions of contract of CLIENT.

1.4 In no case SELLER shall be bound by acts and/or conducts of its agents, being the latter in lack of any power to bind SELLER.

1.5 In case CLIENT is a consumer, the provisions of these General Conditions shall not prejudice the rights of CLIENT provided for by the law applicable to sales executed toward consumers.

2) Products – Modifications

2.1 Any representation and/or image relating to the Products included in websites, brochures, catalogues, price lists or other similar documents of SELLER is approximate and purely illustrative. Likewise, the samples and models are to be considered as only an indication of the Products characteristics in terms of weight, size, aesthetic and technical yield and characteristics and colour and are only an approximate and/or general indication and have no binding value for the SELLER except to the extent that they are expressly mentioned as such in the written acceptance of the offer by the SELLER and do not represent the final aesthetic result of the Products. Technical and physical characteristics of the Products as well as qualities of the same are described in the technical manuals of SELLER only. Any other document including technical and physical characteristics and qualities of the Products are purely indicative and shall not bind SELLER.

2.2 SELLER declares that the Products are compliant with the applicable Italian and European industry standards. Any Products shall be used and applied in accordance with the instructions of use of SELLER included in catalogues and/or technical manuals of SELLER with reference to the Products in question or with the instructions in other way communicated and/or made available by SELLER to CLIENT and, in any case, in accordance with the diligence required by the nature of the Products. Failing to do so, CLIENT will result in the lapse of the warranty and in the unenforceability of the warranty rights under article 7 below or of any other legal or agreed warranty.

2.3 It is the responsibility of CLIENT, before executing of the Sale Contract, to make sure that the Products are suitable for their specific purpose and/or intended use and, in addition, that they also comply with the laws and regulations applicable in the place where CLIENT will import, distribute, sell or use them in any way.

2.4 SELLER may make any changes to the Products which, without altering their essential features, it deems necessary or convenient, even after execution of the Sale Contract. In case SELLER executes substantial modification to Products (e.g. modifications that will alter: the way of installation, characteristic of interchangeability of the Products, etc.) which are the object of an executed Sale Contract (as defined in paragraph 3.2 below), SELLER shall communicate in writing such modification to CLIENT.

2.5 CLIENT shall inform the purchasers of the Products and third parties of the characteristics of the Products and of the instructions of use and of application of the same in accordance with the indication provided by SELLER. Without prejudice to the above, CLIENT shall be the sole responsible and liable for the declarations it will make toward third parties with reference to the Products, their characteristics and their use or application and shall indemnify and hold SELLER harmless and from any damage possibly suffered by SELLER with reference to or in connection to such declarations of CLIENT, in case they result false, incomplete or inaccurate.

3) Quotations – Execution of Sale Contract – Tolerances

3.1 Written or verbal quotations issued by SELLER are not to be taken as valid contractual proposals.

3.2 The sale contract ("Sale Contract") is executed as follows:

a) an offer is sent by SELLER to CLIENT and CLIENT then sends its written acceptance of such offer to SELLER, without any modification to the offer itself; or b) a purchase order is sent by CLIENT and SELLER then sends its written acceptance of such order to CLIENT.

3.3 For the purposes of paragraph 3.2 letter a) above, the following facts or actions shall constitute the written acceptance of an offer of SELLER by CLIENT:

a) the receipt by SELLER of a letter of credit sent by CLIENT;
b) the receipt by SELLER of all or part of the relevant purchase price;
c) the receipt by SELLER of a purchase order of CLIENT. Should this be the case, any order of CLIENT that differs from the provisions of the offer of SELLER shall be binding on SELLER only if and to the extent that SELLER had expressly accepted it in writing.

3.4 In addition, for the purposes of paragraph 3.2 letter b) above, in case the acceptance of SELLER includes terms and condition different from those of the order of CLIENT, the Sale Contract shall be deemed to be concluded at the conditions included in the acceptance of SELLER, unless CLIENT notifies SELLER, in writing, not to accept the terms and conditions of the acceptance of SELLER within 1 (one) working day from the receipt of such acceptance.

3.5 All supplies of Products will only include what is expressly indicated in Sale Contract.

3.6 CLIENT recognizes to SELLER quantity and quality tolerances as resulting from the Sale Contract or from the usage and practices of the sector of the Products.

4) Packing – Delivery term – Delivery time

4.1 The Products will be packaged and readied to ship in compliance with the standard protection methods generally adopted by SELLER for the Products in question, in consideration of the agreed mode of transport.

CLIENT shall expressly request to SELLER any special packaging or supplementary protection it deems necessary, and in such event CLIENT will bear all related costs thereof.

4.2 Unless otherwise provided for in the Sale Contract, the Products shall be delivered to CLIENT in accordance with the Incoterms® ICC rule, latest version, Ex-Works (EXW) – premises of SELLER indicated in the Sale Contract.

CLIENT authorizes SELLER to undersign, in the name and on behalf of CLIENT, any and all transport documents which shall be signed at the time of collection of the Products at the premises of SELLER, such as the CMR.

In the event that the ICC Incoterms® rule agreed between the parties provides that CLIENT shall take care of the transportation of the Products outside the territory of Italy:

a) in case of an Intra-EU supply, within 45 (forty-five) days from the receipt of the Products at its premises, CLIENT shall send SELLER an original or a copy of the international transportation document CMR or of another transportation document, undersigned at destination by CLIENT or, in the absence of the international transportation document CMR, a declaration of receipt of the Products issued on the basis of the form as Annex -1- available for download at www.panariagroup.it;

b) in case of an Extra-EU supply, CLIENT shall:

i) submit the custom export declaration (SAD-EX + EAD) and execute the validation of the MRN (Movement Reference Number) at the customs of the UE territory of exit of the Products, within 90 (ninety) days from the date of delivery of the same in Italy;

ii) send SELLER, within 90 (ninety) days from the date of delivery, documents proving the exportation of the Products (custom export declaration SAD-EX + EAD + certification of exit);

iii) notify SELLER, in writing, as soon as such submission is accomplished and provide SELLER with any other document proving the execution of such formalities as well as the exit of the Products from the UE Territory.

In case CLIENT is in breach of its obligations under this paragraph 4.2, SELLER shall be entitled to immediately charge CLIENT the amount of the Value Added Tax applicable to the supply and connected to the lack of proof of the transportation of the Products in a another Member State of the EU or to the lack of execution of custom clearance formalities. In any case, CLIENT shall indemnify and hold SELLER harmless with reference to any payment due to tax offices for fines, interests or on any other basis, in connection with the supply and with the lack of the proof of the transportation of the Products in a another Member State of the EU or with the lack of execution of custom clearance formalities.

In this respect, SELLER shall be entitled to: (i) offset any amount due by CLIENT on the basis of this paragraph 4.2 against any amount due, for whatever reason, from SELLER to CLIENT; or (ii) definitively withhold any amount received in regard to Sale Contracts, offsetting the CLIENT's debt under this paragraph 4.2 against any and all sums already paid by CLIENT.

4.3 SELLER shall deliver the Products within the delivery date provided for in the Sale Contract, in a single delivery or in partial deliveries. The delivery date shall always be considered neither of the essence nor peremptory. Except in case of wilful wrongdoing or gross negligence, SELLER will not reimburse possible damages, either direct or indirect, suffered by CLIENT as a result of delay in the delivery of the Products.

In no case of delay in the delivery of the Products shall CLIENT be entitled to terminate the Sale Contract.

4.4 Upon receipt of the Products, CLIENT must report possible damages occurred to the packaging and/or shortages or anomalies of the Products occurred during the transport, by notifying details of such events on the transportation document, and must also:

a) have such notification countersigned by the carrier; and
b) immediately inform SELLER thereof, in writing, and send SELLER a copy of the countersigned document by and no later than 8 (eight) day(s) from the date of receipt of the Products.

Should this not be the case, SELLER shall not be responsible for possible damages losses or theft of the Products occurred during the transport, even if transport risks were, in whole or in part, upon SELLER.

5) Prices – Payment – Late Payment

5.1 The Products shall be supplied at the prices agreed between the parties in the Sale Contract or, should no prices be mentioned in the Sale Contract, at the prices resulting from the price list of SELLER in force when the Sale Contract has been executed. Unless otherwise stated in writing, the prices of the Products included in SELLER's price lists, quotations and/or offers are in Euro, net of VAT and for delivery according to the Incoterms® ICC rule, latest version, Ex-Works (EXW) - premises of SELLER indicated in the Sale Contract. Therefore, should a different Incoterms® rule be agreed upon between the parties for the delivery of the Products, the invoiced amount shall be modified accordingly, including in the sale invoice transportation expenses and any other costs connected with the Incoterms® rule agreed between for delivery.

5.2 CLIENT shall pay for the Products in accordance with the payments methods and terms provided for in the Sale Contract or otherwise agreed upon in writing between the parties. No payment shall be considered as being made by CLIENT until the relative amount has been credited to the bank account of SELLER.

Payment shall be executed by CLIENT in Euro or in the currency of the place where CLIENT has its registered office, at SELLER's discretion, in accordance with the currency indicated by SELLER in the related sale invoice.

5.3 If CLIENT is delinquent in its payment obligation, SELLER may:

a) obtain payment of late payment interest in accordance with the applicable law; and

b) withhold ongoing and future deliveries, upon written notice to CLIENT, until all delinquent amounts and late payment interest are fully paid.

5.4 If delinquent amounts and late payment interest remain unpaid 30 (thirty)

days after the agreed deadline for payment, then SELLER may also, at its option, alternatively or cumulatively, and in addition to any other right or remedy available at law or pursuant to these General Conditions:

a) request accelerated payment of any and all remaining payments and declare due the total outstanding balance, even if payment by instalment or deferred payment has been agreed upon and/or bills of exchange, promissory notes, cheques or other payment documents have been issued and are falling due;

b) terminate the Sale Contract in question and definitively withhold any amount received in regard to such Sale Contract or to other Sale Contracts, offsetting the CLIENT's outstanding debt against any and all sums already paid by CLIENT;

c) carry out future deliveries of Products on a pre-payment basis only, also with reference to supplies still to be executed;

d) cancel discounts and bonuses that may have been agreed between the parties also with reference to Sale Contracts already regularly executed.

5.5 SELLER shall be entitled to exercise the rights mentioned in paragraphs 5.3 and 5.4 above also in case:

a) CLIENT is undergoing winding-up, bankruptcy, debt restructuring or enforcement proceedings;

b) the insurance company of SELLER refuses insurance coverage for SELLER's credits toward CLIENT;

c) CLIENT is undergoing financial difficulties able to hinder the regular execution of its payment obligations resulting from, by way of example only, missed payment of bills of exchange, promissory notes, cheques or other payment documents, reduction of granted guarantees and/or missed granting of promised guarantees, as well as from any amount resulting unpaid, even though such circumstances have occurred with other suppliers of CLIENT.

5.6 CLIENT cannot claim any breach of contract by SELLER, nor can CLIENT start any lawsuit or action against SELLER, until any amount resulting due to SELLER under paragraphs 5.3 and 5.4 above has been paid in full by CLIENT.

6) Retention of Title

6.1 SELLER will maintain exclusive ownership over the Products sold until their price has been entirely paid by CLIENT.

Without prejudice to the above the risks of loss of the Products shall be regulated by the Incoterms® rule agreed between the parties for the delivery of the Products.

6.2 In case of non-fulfillment or late fulfillment of the obligation to pay the price of the Products, without prejudice to the rights under paragraphs 5.4, 5.5 and 5.6, SELLER shall be entitled to enter the premises where the Products are held, repossess the Products and withhold, as liquidated damages, any amount already paid by CLIENT with reference to such Products.

7) Warranty

7.1 Without prejudice to the provisions of paragraphs 2.1, 2.2, 2.4 and 3.6 with reference to the modifications to the Products and tolerances, SELLER warrants that the Products will conform to the Sale Contract, to the classification indicated in the technical manuals, catalogues and/or price lists of SELLER and that they will be free from manufacturing defects.

The warranty period is 12 (twelve) months from the date of collection of the Products from the premises of SELLER, regardless of the agreed Incoterms® rule for delivery.

7.2 The following are expressly excluded from warranty:

a) chromatic alterations and tone differences of the Products;

b) the Products identified in the Sale Contract as Products of quality lower than first-quality Products or as close-out sale Products or as special batches;

c) the Products applied and/or set up not in compliance with the industry standards applicable to the same;

d) the Products used or applied on surfaces and/or in spaces or environments different from those indicated by SELLER;

e) the Products used not in compliance with the instructions and/or indications provided by SELLER included in the catalogues and price lists of SELLER or in other way communicated to CLIENT by SELLER, included the instructions under paragraph 2.2;

f) the Products used not in compliance to the standard diligence and/or to the technics required by the nature of the Products;

g) frost resistance of the Products, unless such characteristic of the Products has been declared by SELLER in the technical manual of the Products;

h) characteristics of the Products as resulting from the classification of the pottery (i) executed by control and/or certification authorities other than authorities of the European Union Member States, and/or (ii) executed on the basis of criteria other than those used by SELLER.

7.3 Without prejudice to the provisions of paragraph 4.4 above, CLIENT shall inspect the Products as soon as possible and shall notify SELLER in writing of possible non-conformities or defects, by fax or email, within and no later than the following terms; failing to do so will result in the lapse of the warranty and the unenforceability of the warranty rights:

a) differences in type or quantity with respect to type or quantity agreed as well as other patent non-conformities or defects of the Products: 8 (eight) days from the delivery of the Products at the premises of CLIENT and, in any case, before application of the Products;

b) hidden non-conformities or defects of the Products: 8 (eight) days from the discovery of the same and, for avoidance of doubt, within the warranty period.

7.4 SELLER will have the right to examine the Products, or samples of the Products, which CLIENT claims to be non-conforming or defective, in order to verify the instructions relating to the set up and/or application of the Products and/or the use of the Products in accordance with the provisions of these General Conditions. In this respect, CLIENT shall be entitled to return to SELLER the Products that CLIENT considers to be non-conforming or defective only upon SELLER's written authorization and only on the condition that CLIENT bears all costs and risks for the shipment of the Products. The authorization to return the Products or samples of the purportedly non-conforming or defective Products shall never be interpreted as an acknowledgment of the claimed non-conformities or defects on the part of SELLER.

7.5 In case the Products are ascertained by SELLER as actually non-conforming or defective, CLIENT will be entitled only to obtain, at the SELLER's option:

a) replacement of the non-conforming or defective Products; or

b) partial or full exemption from payment of their price, depending on the seriousness of the non-conformities or of the defects.

7.6 For the purpose of paragraph 7.5 letter (a), the Products to be delivered in replacement of non-conforming or defective Products shall be delivered to CLIENT in accordance with the Incoterms® 2010 ICC rule DDP - premises of CLIENT. The Products that have been replaced shall be, at SELLER's discretion, destroyed or disposed of by CLIENT, at its own costs, or returned to SELLER, at costs of SELLER. In case the Products are to be destroyed or disposed of by CLIENT, CLIENT undertakes to send to SELLER the proof of destruction or of disposal of the Products, along with the documents proving the costs borne by CLIENT for the destruction or the disposal of the same.

7.7 The rights and remedies described in paragraphs 7.5 and 7.6 above are the sole warranty rights and remedies granted to CLIENT. To the maximum extent permitted by the applicable law, any other liability and obligation of SELLER, which may in any way arise from or in relation to the supply of non-conforming or defective Products - including, but not limited to, compensation for direct or indirect or consequential damages, loss of profits, etc. connected to such liability - is expressly excluded.

7.8 The present warranty is in substitution for, and excludes, any other warranty, express or implied, set forth by the law or otherwise.

8) Force Majeure

8.1 SELLER shall not be liable or responsible for failure or delay in performing or fulfilling any obligations undertaken in reference to the supply of Products when such failure or delay is due to the occurrence of an event of force majeure such as wars, fires, earthquakes, floods, tsunami, strikes, labor or employment difficulties, shortage or procurement difficulties of raw materials, restriction on the use of power, suspension or difficulties in the transports, breakdown of the plants, acts of public authorities or any other event or cause whatsoever, similar or dissimilar, which cannot reasonably be forecast or provided against and which cannot be overcome by SELLER with reasonable diligence.

8.2 In such event, the time for fulfillment of the obligation shall be extended for the period of continuance of such force majeure event.

In the event any of such force majeure event continue for a period longer than 6 (six) months, CLIENT shall have the right to terminate the underlying Sale Contract, by giving written notice to SELLER by registered letter with return receipt or courier, and SELLER shall not incur any responsibility or liability whatsoever.

9) Severability

The invalidity or unenforceability of any provision, or portion thereof, of this General Conditions shall not affect the validity or enforceability of any other provision.

10) Confidentiality

10.1 CLIENT undertakes: (i) to treat with the utmost confidentiality all the information/data/designs/know-how/documentation transmitted by SELLER or that it may come to know in connection with the execution of any Sale Contract, even if they is not marked or identified as secret or confidential ("Confidential Information"); (ii) not to, wholly or partially, disclose to or inform third parties of the Confidential Information, without the SELLER's prior written consent; (iii) to limit the use of the Confidential Information and the access to the same for purposes relating to the execution of the sale Contracts; (iv) to adopt any and all measures required in order for its employees and collaborators do not disclose the Confidential Information to third parties or use it in an inappropriate way.

The Confidential Information shall not be copied or reproduced in any way, unless with the prior written consent of SELLER, and all the copies of the Confidential Information shall be immediately returned to SELLER upon simple written request of the same.

10.2 The provisions above shall not apply to information which (i) are public or publicly available not due to a disclosure of CLIENT or of CLIENT's employees or collaborators; or (ii) were already available to CLIENT before it had received them by SELLER; or (iii) are disclosed from third parties that have no obligation of confidentiality or restrictions of use on the same; (iv) can be disclosed according to a written authorization of SELLER.

11) Applicable Law – Dispute Resolution

11.1 These General Conditions and all the Sale Contracts that will occur on the basis on the same will be governed by the United Nations Convention on Contracts for the International Sale of Goods (Vienna Convention of 1980) and, with respect to matters not covered by such Convention, by Italian laws.

11.2 Any dispute arising out of or in connection with these General Conditions or in connection with a Sale Contract occurred on the basis on the same shall be settled in accordance with the following provisions:

a) In case CLIENT has its registered office within the European Union, in Switzerland, in Norway or in Iceland, the dispute shall be subjected to the jurisdiction of the Italian courts and shall be exclusively referred for its resolution to the Court of Modena (Italy).

b) In any other case, the dispute shall be exclusively referred to and finally resolved by arbitration, by a sole arbitrator, in accordance with the Rules of the Milan Chamber of Arbitration (the Rules).

The seat of arbitration shall be, and the award shall be delivered in, Milan (Italy).

The language to be used in the arbitral proceedings shall be English.

11.3 Irrespective of the provisions above, it is hereby granted exclusively to SELLER the right to initiate legal proceedings under the jurisdiction of CLIENT before the competent court.

12) Language of these General Conditions

12.1 The text of these General Conditions is executed in both in Italian and in English language. In case of any discrepancy, the text in Italian shall prevail over the text in English language.

These general terms and conditions of sale are published and downloadable on the website www.panariagroup.it



Ceramics of Italy

Seguici su / Follow us on



Group Marketing & Communications - Panariagroup
Gennaio 2023

Panaria
ceramica

via Panaria Bassa, 22/a
41034 Finale Emilia (Modena) - Italy
Tel. +39 0535 95111 - Fax +39 0535 90503
info@panaria.it - panaria.it

PANARIAGROUP INDUSTRIE CERAMICHE S.p.A.
panariagroup.it